



Print Area — SPARE PARTS

COMPANY PROFILE



20+ Year Professional Experience In Printing Industry



160+ Countries Recognition



10000+ Customers Admire Our Service



One-stop Printing Materials Supplier



TABLE OF CONTENTS

1	Rubber Sucker -----	Y1
2	Brush Wheel -----	Y6
3	Belt -----	Y8
4	Heidel-berg Series Spare Part -----	1
5	Ro-land Series Spare Part -----	37
6	Ko-maori Series Spare Part -----	67
7	Ryo-bi / Ha-mada Series Spare Part -----	76
8	K-BA / Mi-tsubshi / Mill-er Series Spare Part ----	78
9	Folding Machine Spare Part -----	83
10	Stitching Machine Spare Part -----	84
11	Paper Cutting Machine Spare Part -----	87
12	Tools -----	89
13	Other Spare Part -----	90

Printed Jan. 2024

EISI® Rubber Sucker

N=Number OD=Outside Diameter ID=Inside Diameter T=Thickness H=Height (Unit : mm)



Import Material

Code	OD	ID	T
YY1J01841	32mm	13mm	0.5mm
YY1J01851	32mm	13mm	0.8mm
YY1J01861	32mm	13mm	1mm
YY1J01871	32mm	15mm	0.7mm
YY1J01881	32mm	15mm	1mm
YY1J01891	35mm	15mm	0.7mm
YY1J01901	35mm	15mm	1mm
YY1J01911	38mm	13mm	0.5mm
YY1J01921	38mm	13mm	0.8mm
YY1J01931	38mm	13mm	1mm
YY1J01941	38mm	15mm	0.7mm
YY1J01951	38mm	15mm	1mm



China Material

Code	OD	ID	T
YY1J01961	25mm	6mm	1mm
YY1J01971	30mm	6mm	1mm
YY1J01981	32mm	13mm	0.5mm
YY1J01Y11	32mm	13mm	1mm
YY1J02001	32mm	15mm	0.8mm
YY1J02011	32mm	15mm	1mm
YY1J02021	35mm	13mm	0.5mm
YY1J02031	35mm	13mm	1mm
YY1J02041	35mm	15mm	0.5mm
YY1J02051	35mm	15mm	0.8mm
YY1J02061	35mm	15mm	1mm
YY1402071	38mm	13mm	0.5mm
YY1J02081	38mm	13mm	0.8mm
YY1402091	38mm	13mm	1mm
YY1J02101	38mm	15mm	0.5mm
YY1J02111	38mm	15mm	0.8mm
YY1J02121	38mm	15mm	1mm
YY1J02131	42mm	15mm	1mm
YY1J02141	45mm	15mm	1mm



Silicon Dioxide

Code	OD	ID	T
YY1J02151	22mm	4mm	1mm
YY1J02161	26mm	5mm	1mm
YY1J02171	30mm	5mm	1mm
YY1J02181	30mm	7mm	1mm
YY1J02191	32mm	10mm	0.5mm
YY1J02201	32mm	10mm	1mm
YY1J02211	32mm	12mm	0.5mm
YY1J02221	32mm	14mm	1mm
YY1J02231	35mm	14mm	1.5mm
YY1J02241	35mm	14mm	1mm
YY1J02251	38mm	10mm	2.5mm
YY1J02261	38mm	14mm	0.5mm
YY1J02271	38mm	14mm	1mm
YY1J02281	38mm	14mm	2mm
YY1J02291	38mm	7mm	1mm
YY1J02301	38mm	9mm	1mm
YY1J02311	40mm	14mm	1mm
YY1J02321	45mm	14mm	1mm
YY1J02331	50mm	6mm	2mm
YY1J02341	50mm	12mm	1mm
YY1J02351	50mm	15mm	1mm



RibporLmx

Code	OD	ID	T
YY1J02361	18mm	6mm	1mm
YY1J02371	21mm	5mm	1mm
YY1J02381	22mm	4mm	1mm
YY1J02391	24mm	7mm	1mm
YY1J02401	25mm	1mm	1mm
YY1J02411	25mm	2mm	1mm
YY1J02421	25mm	10mm	1mm
YY1J02431	26mm	4mm	1mm
YY1J02441	27mm	10mm	1mm
YY1J02451	29mm	14mm	1mm
YY1J02461	30mm	5mm	1mm
YY1J02471	30mm	8mm	1mm
YY1J02481	30mm	9mm	1mm
YY1J02491	30mm	12mm	1mm
YY1J02501	32mm	5mm	1mm
YY1J02511	32mm	10mm	1mm
YY1J02521	32mm	14mm	1mm
YY1J02531	85m0	6mm	1mm
YY1J02541	35mm	10mm	1mm
YY1J02551	35mm	15mm	1mm
YY1J02561	38mm	7mm	1mm
YY1J02571	38mm	8mm	1.5mm
YY1J02581	38mm	10mm	1mm
YY1J02591	38mm	12m	1mm
YY1J02601	38mm	14mm	1mm
YY1J02611	40mm	6mm	1mm
YY1J02621	40mm	9mm	1mm
YY1J02631	42mm	10mm	1mm
YY1J02641	42mm	12mm	1mm
YY1J02651	45mm	14mm	0.8mm
YY1J02661	50mm	10mm	1mm



Rubber

Code	OD	ID	T
YY1J02671	22mm	4mm	0.8mm
YY1J02681	22m	5mm	0.5mm
YY1J02691	22mm	5mm	1mm
YY1J02701	27mm	10mm	0.5mm
YY1J02711	32mm	10mm	1mm
YY1J02721	32mm	14mm	0.5mm
YY1J02731	32mm	14mm	1mm
YY1J02741	32mm	6mm	1mm
YY1J02751	34mm	7mm	1mm
YY1J02761	35mm	14mm	0.5mm
YY1J02771	35mm	14mm	1mm
YY1J02781	38mm	12mm	0.8mm
YY1J02791	38mm	14mm	0.5mm
YY1J02801	38mm	14mm	1mm
YY1J02811	38mm	7mm	1mm
YY1J02821	39mm	6mm	0.8mm
YY1J02831	40mm	14mm	0.5mm
YY1J02851	40mm	9mm	1mm
YY1J02861	45mm	15mm	1mm
YY1J02871	45mm	7mm	1.5mm
YY1J02881	50mm	10mm	1mm
YY1J02891	50mm	15mm	2mm



Polyurethane

Code	OD	ID	T
YY1J02901	32mm	14mm	1mm
YY1J02911	35mm	14mm	1mm
YY1J02921	36mm	14mm	1mm
YY1J02931	38mm	14mm	1mm
YY1J02941	40mm	14mm	1mm
YY1102951	45mm	15mm	1mm
YY1J02961	50mm	14mm	1mm



HUEbeTLalex

YY1J02971	32mm	15mm	1mm
YY1J02981	35mm	14mm	1mm
YY1J02Y11	38mm	14mm	1mm
YY1J03001	38mm	15mm	1mm
YY1J03011	42mm	14mm	1mm

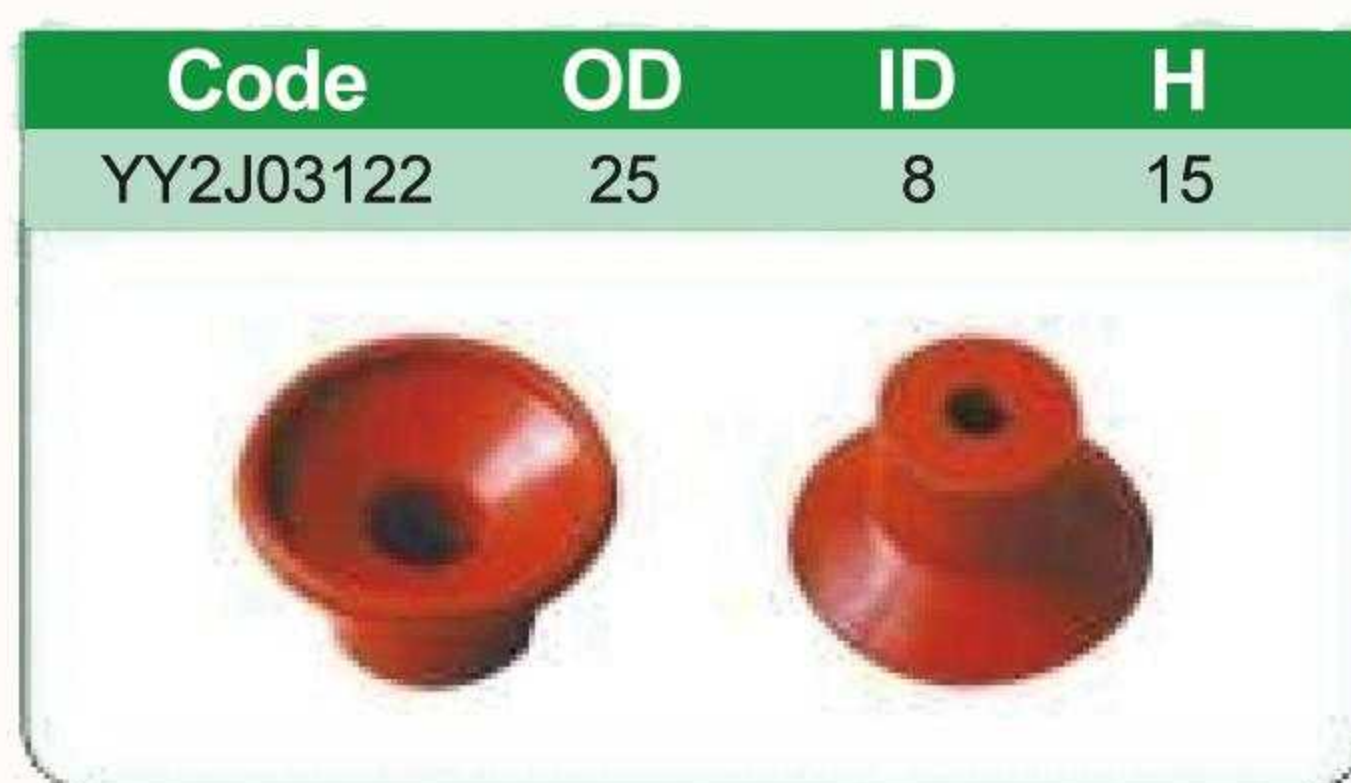
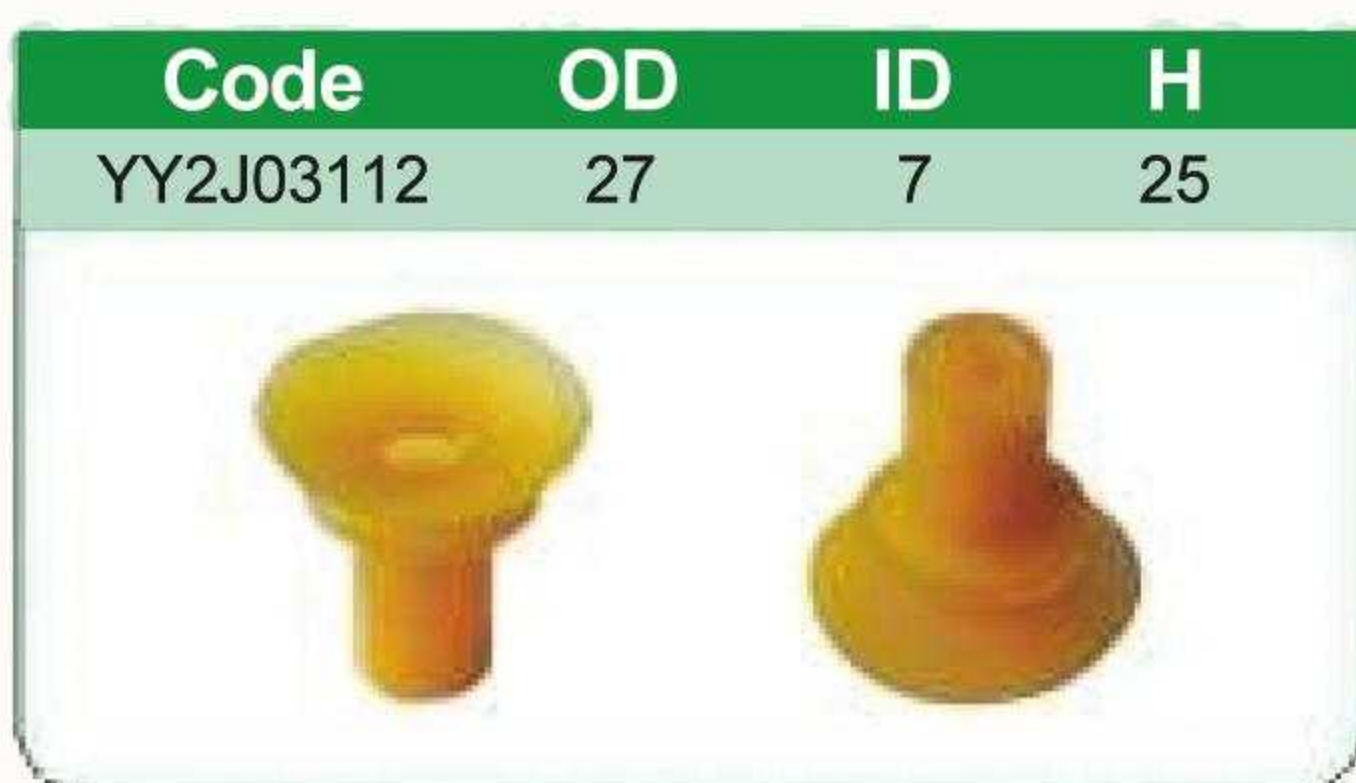
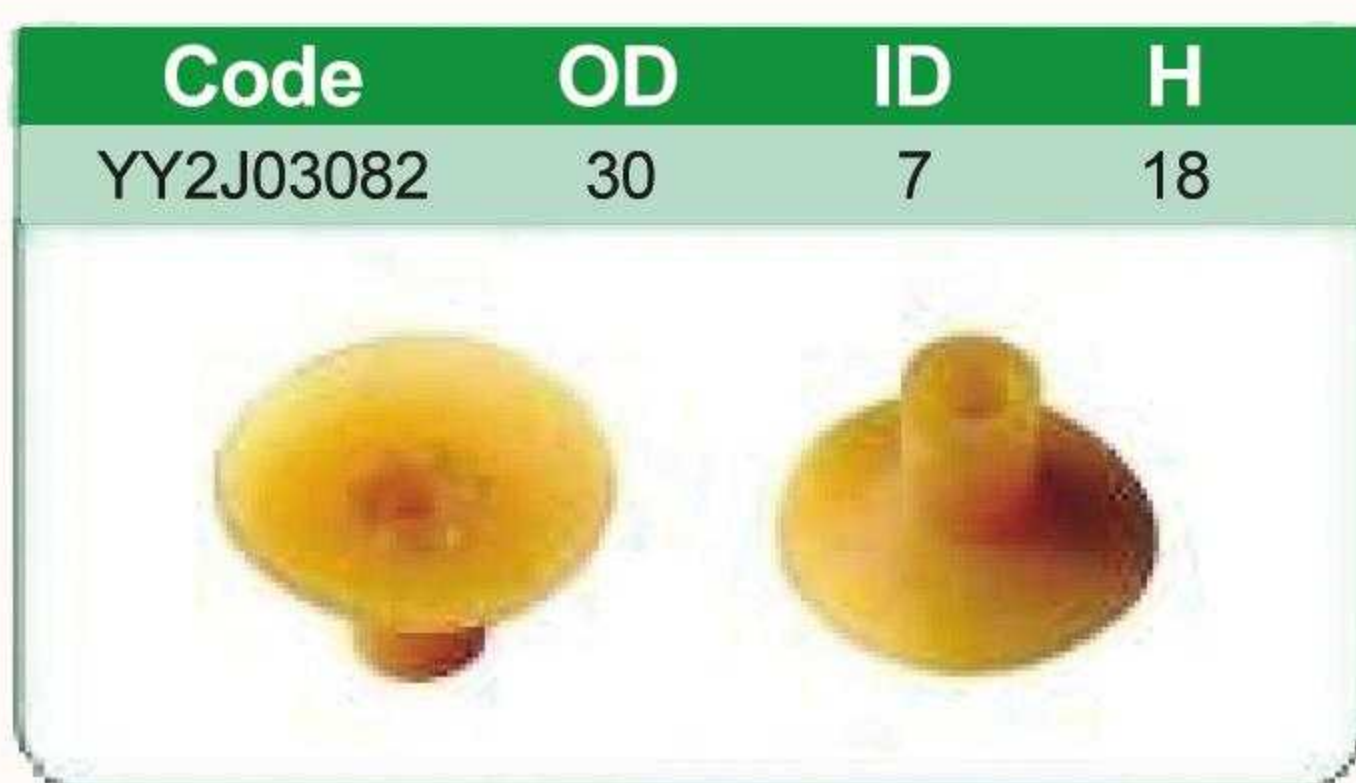
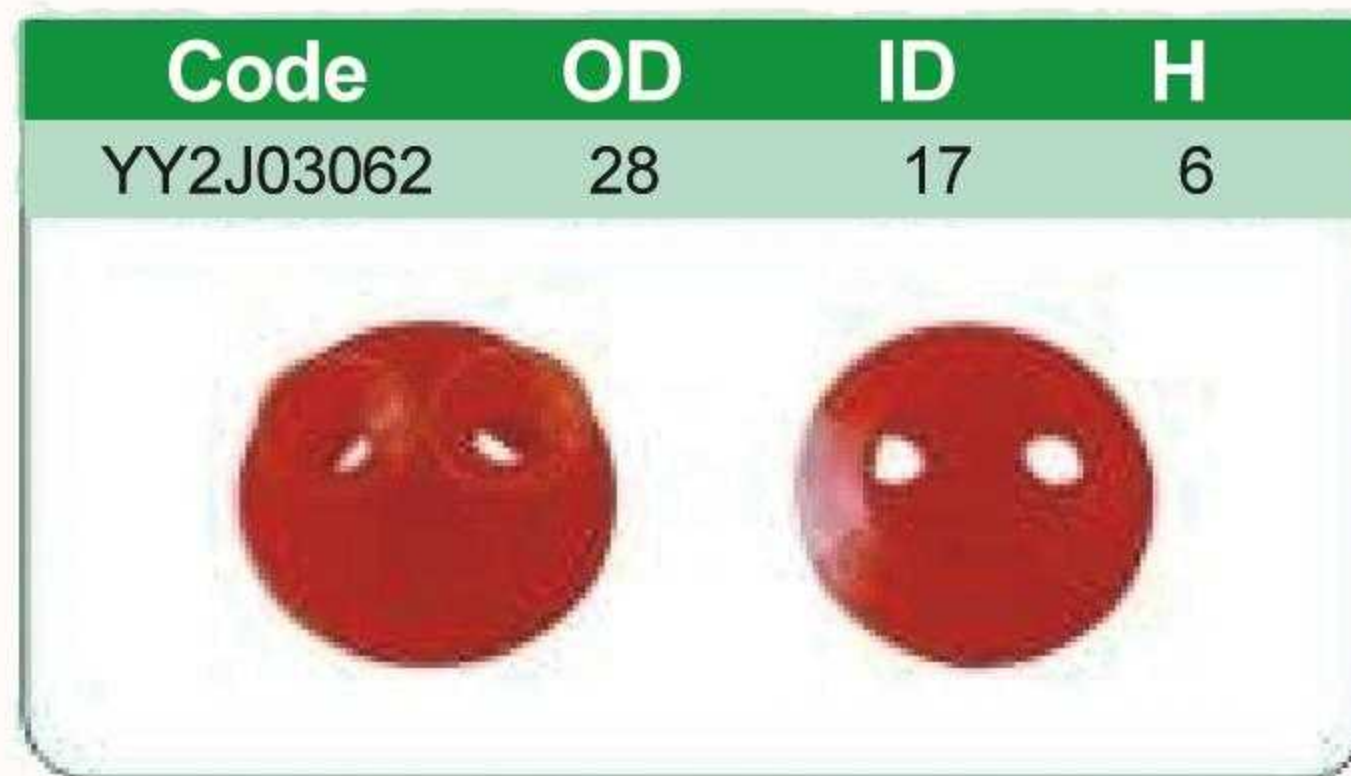
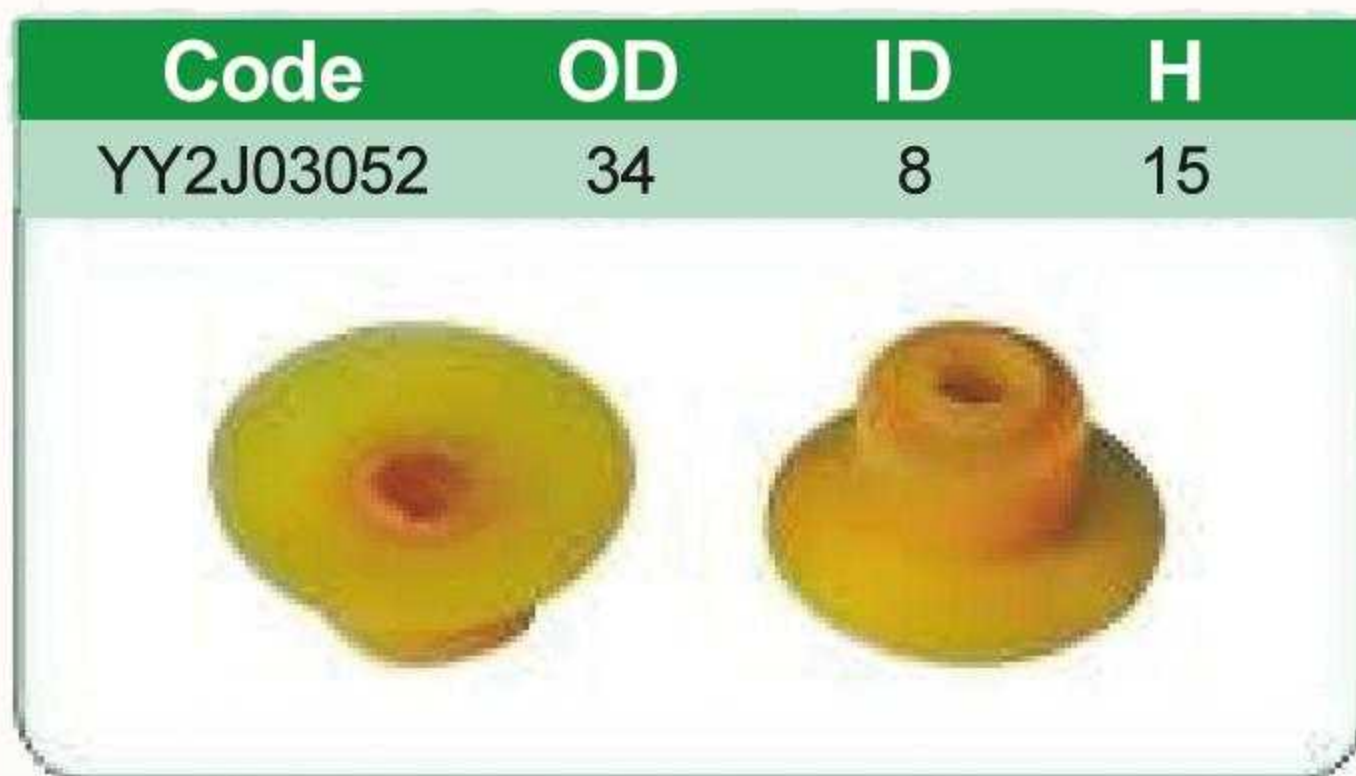
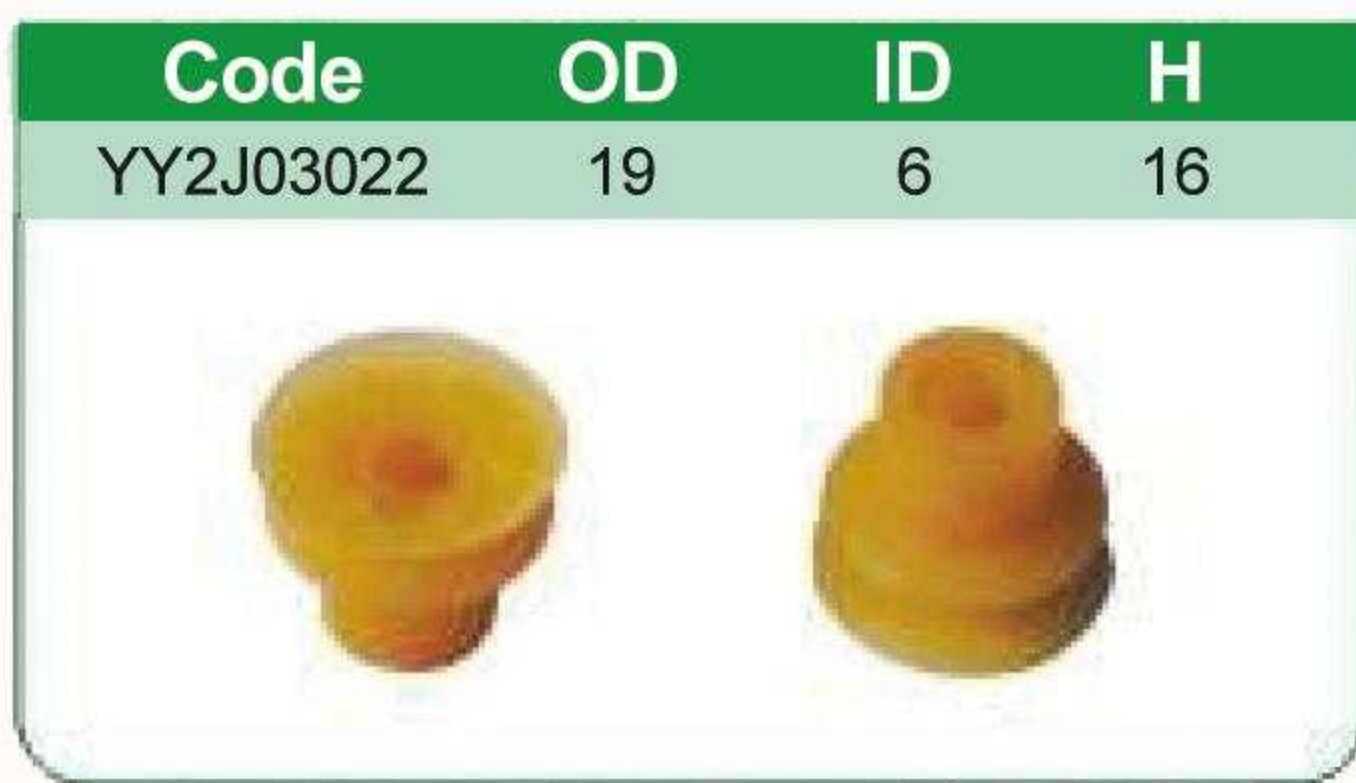

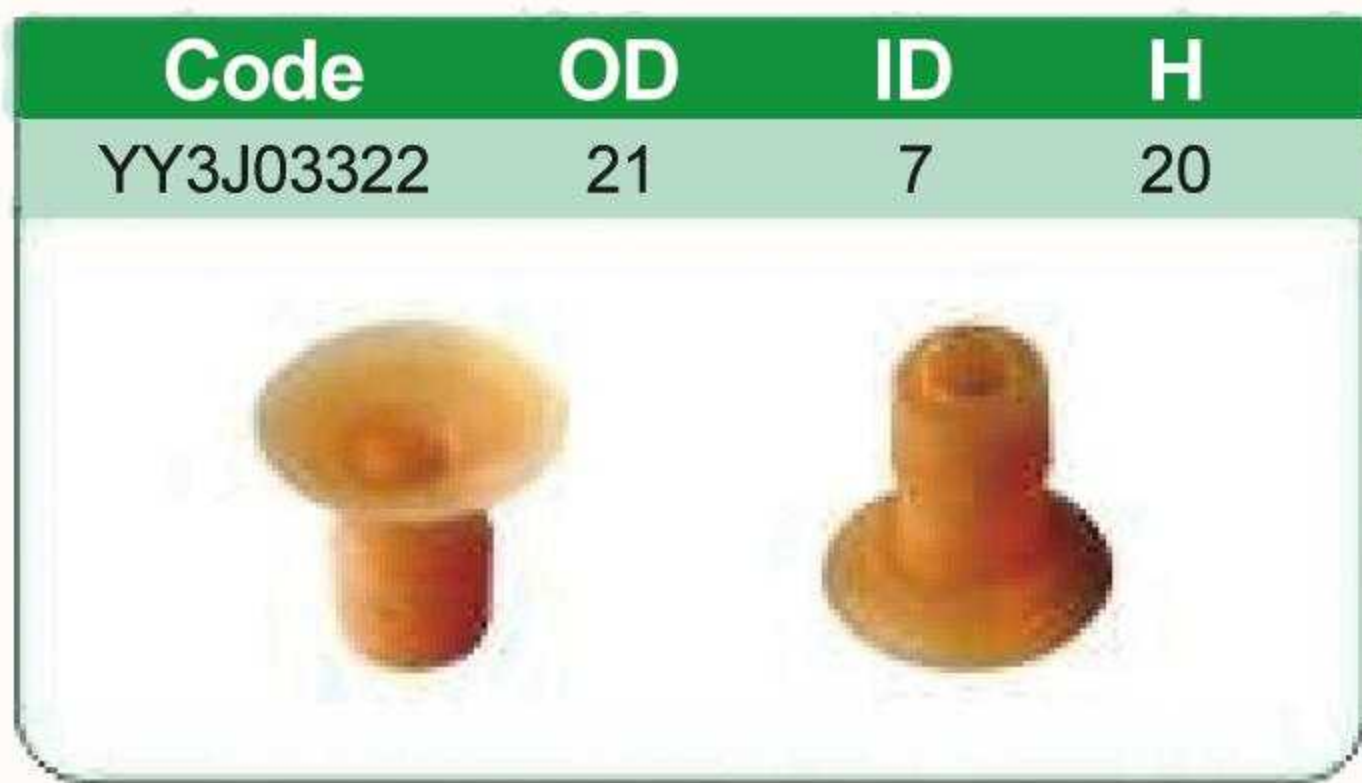
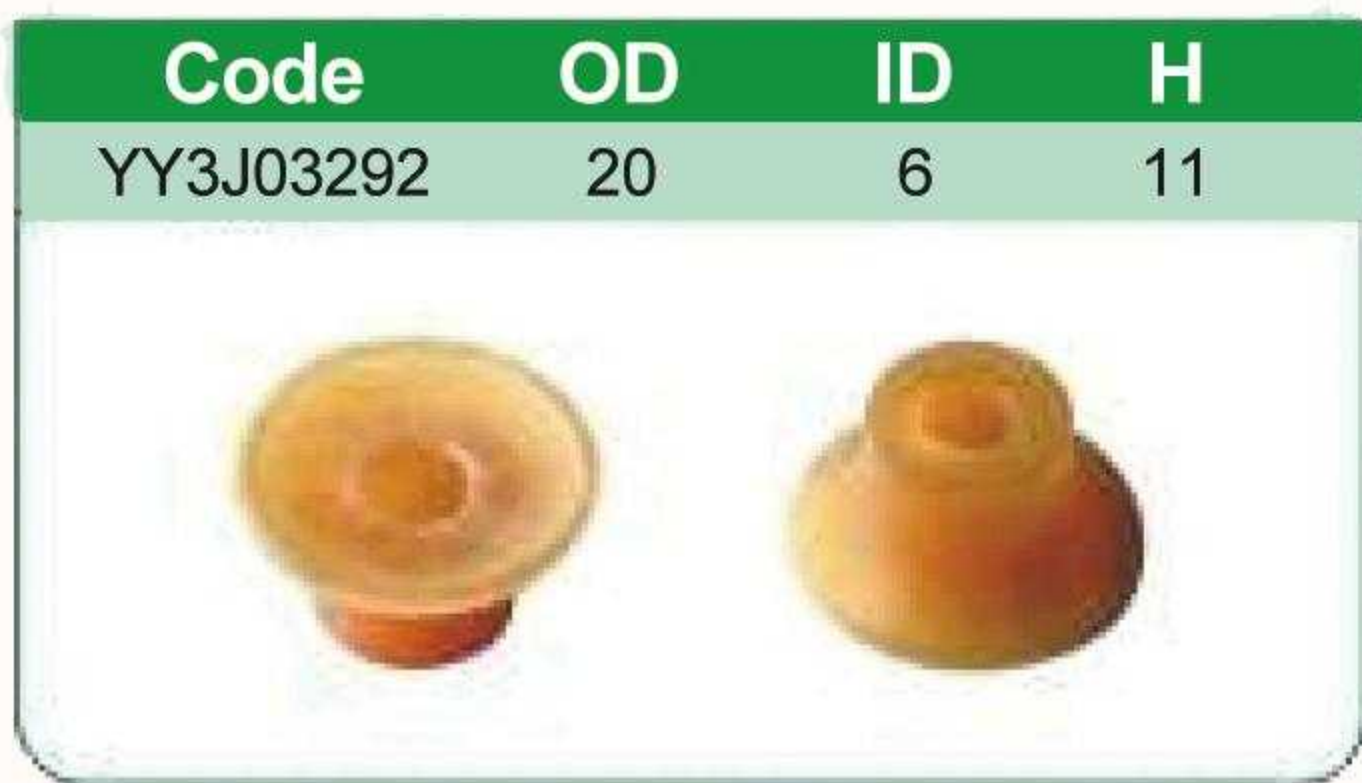
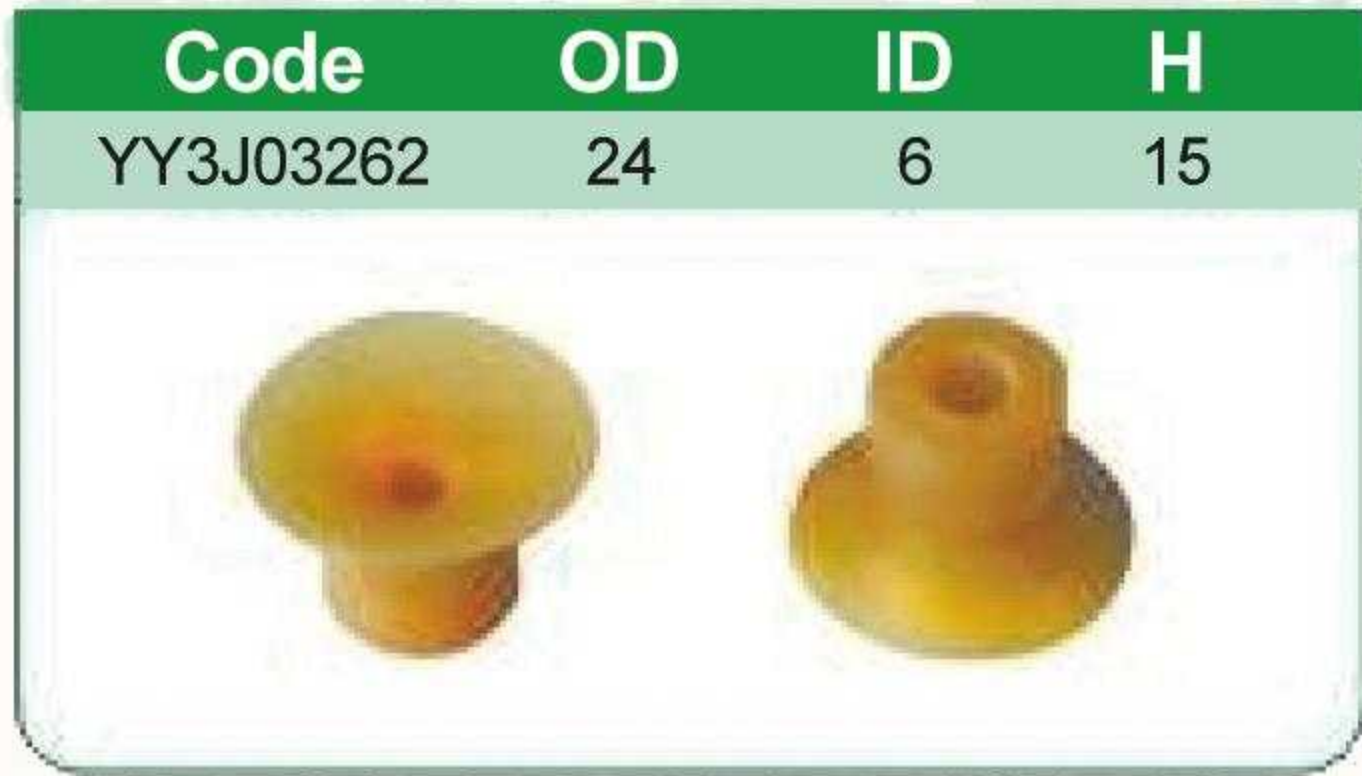
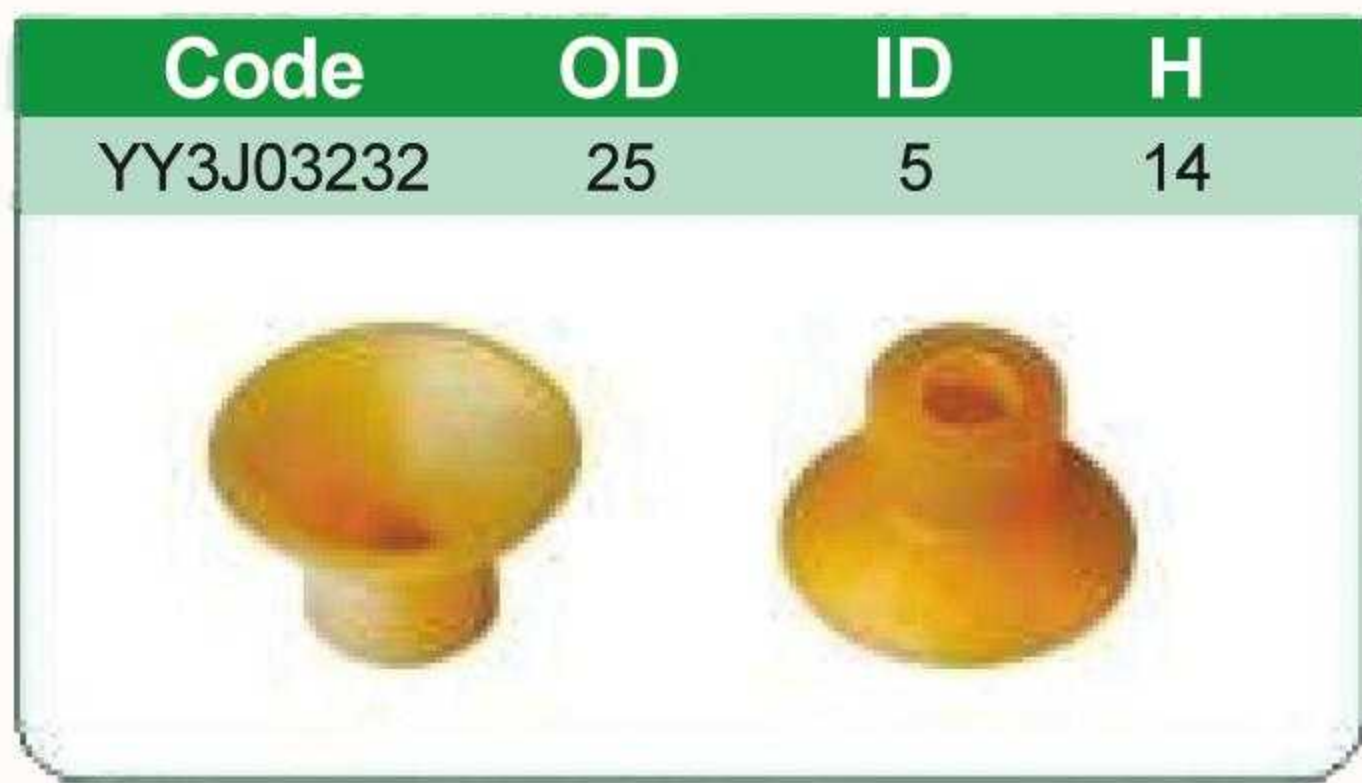

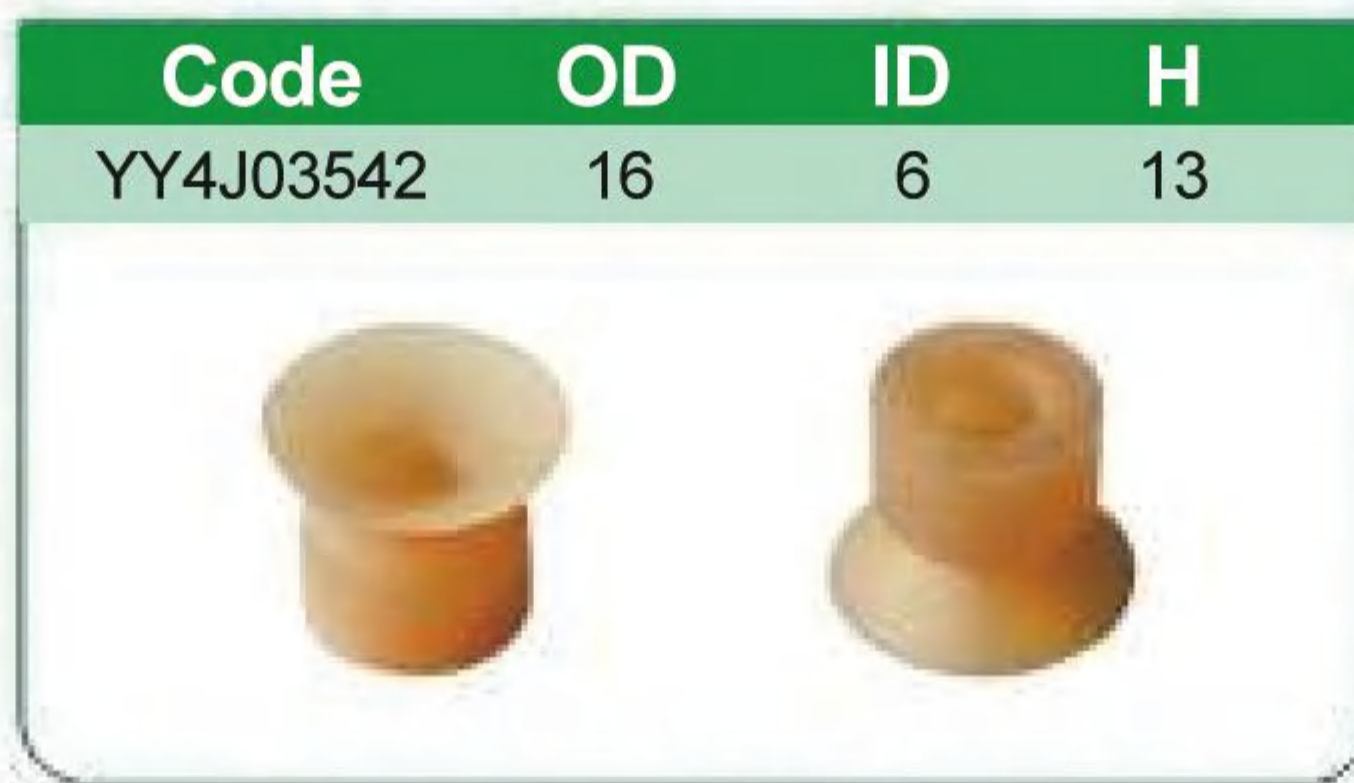
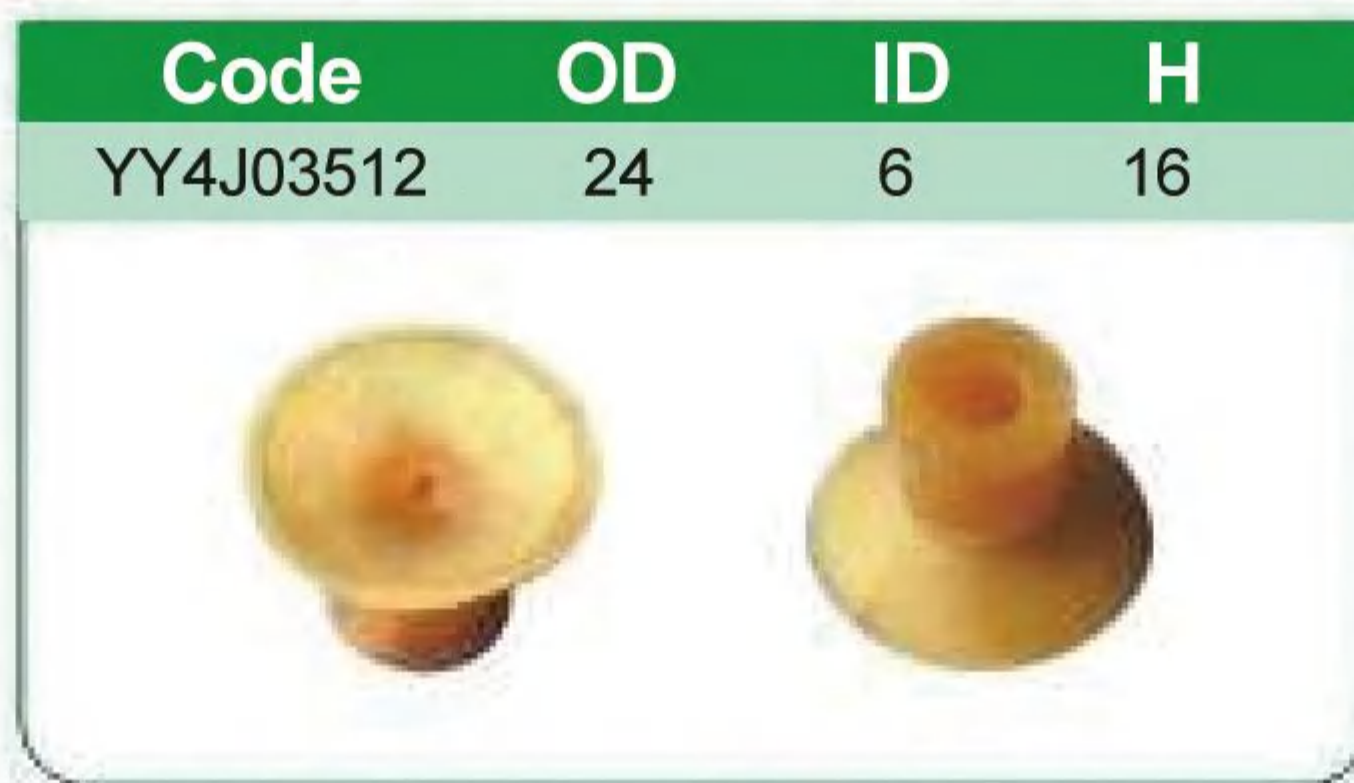
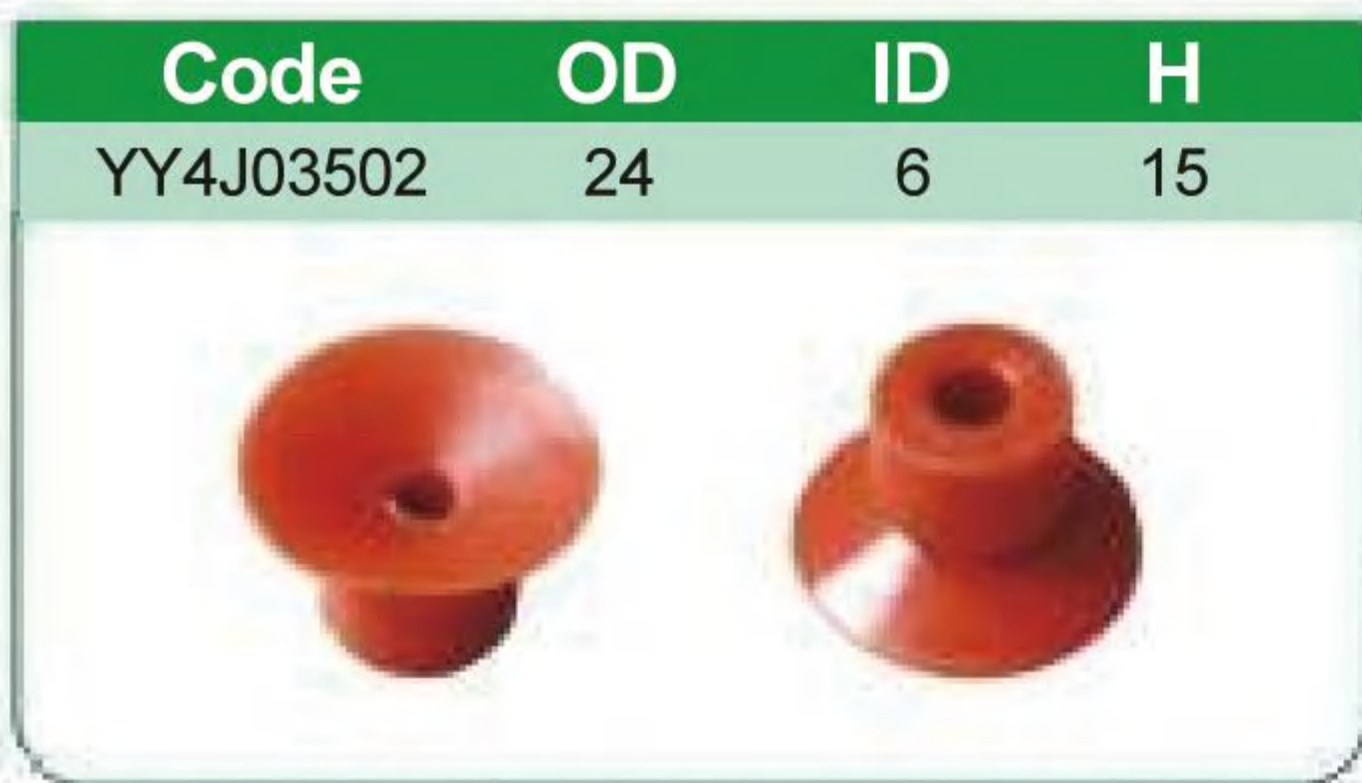
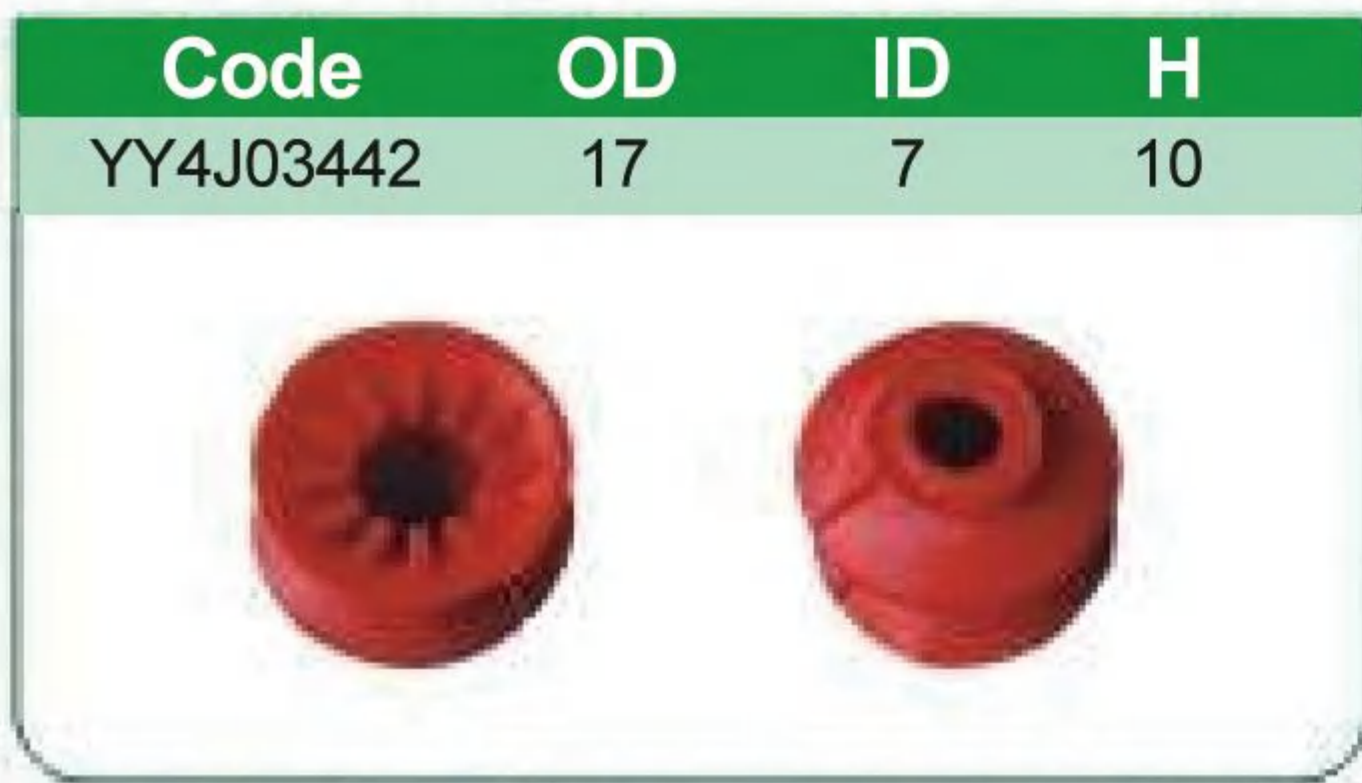

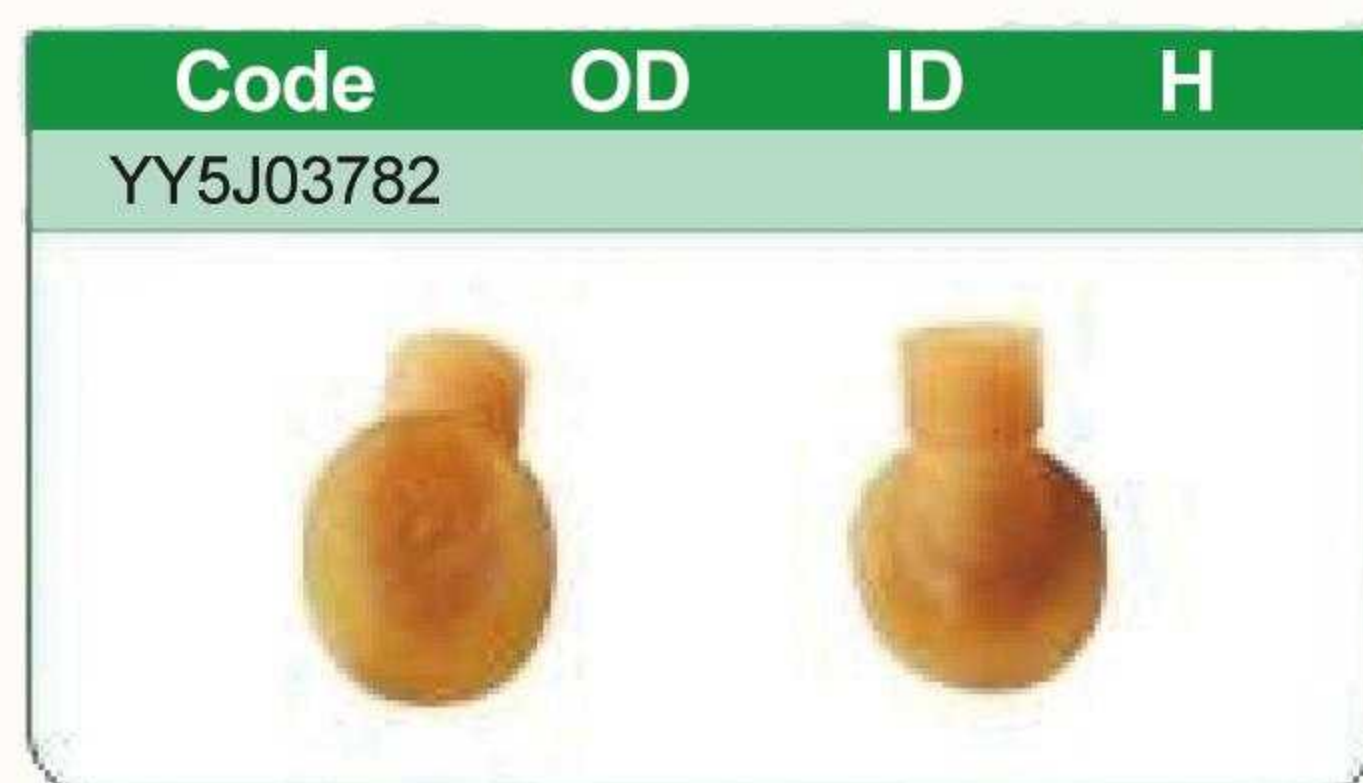
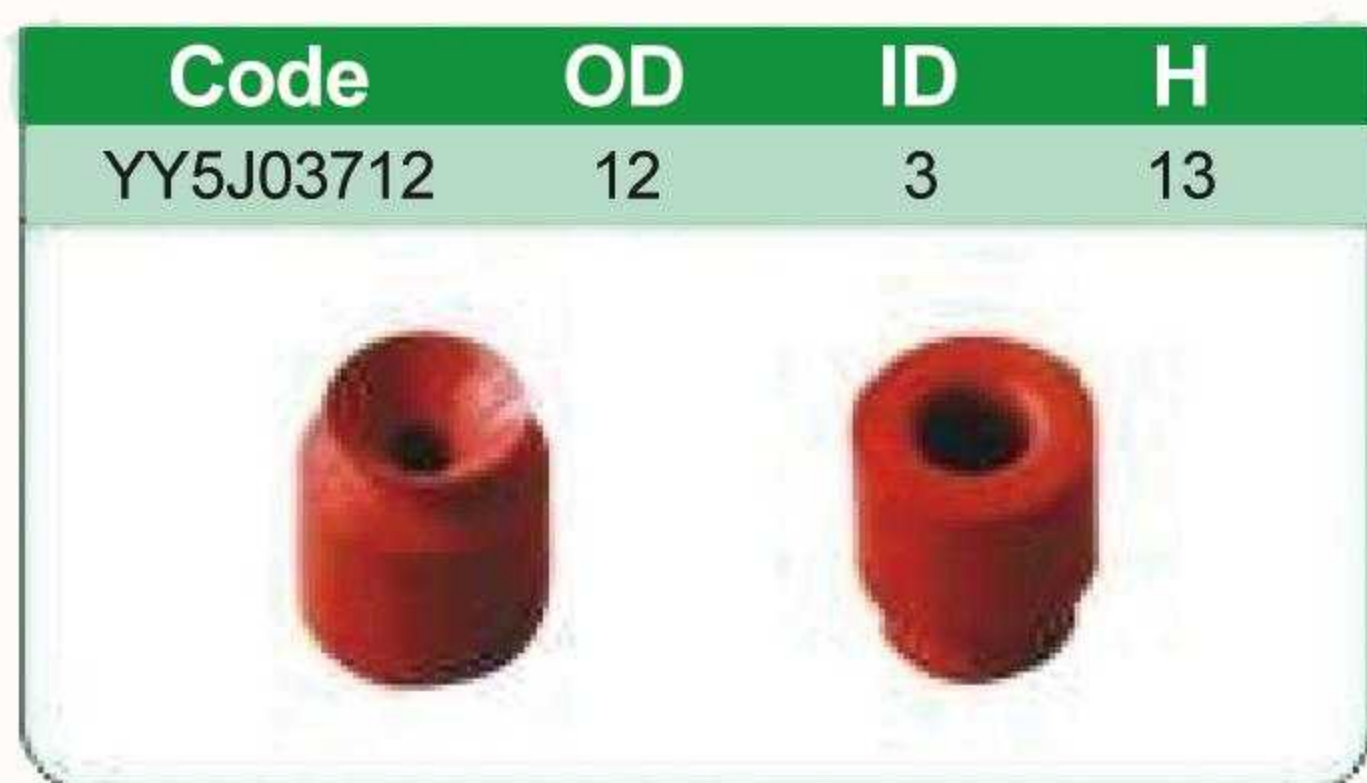
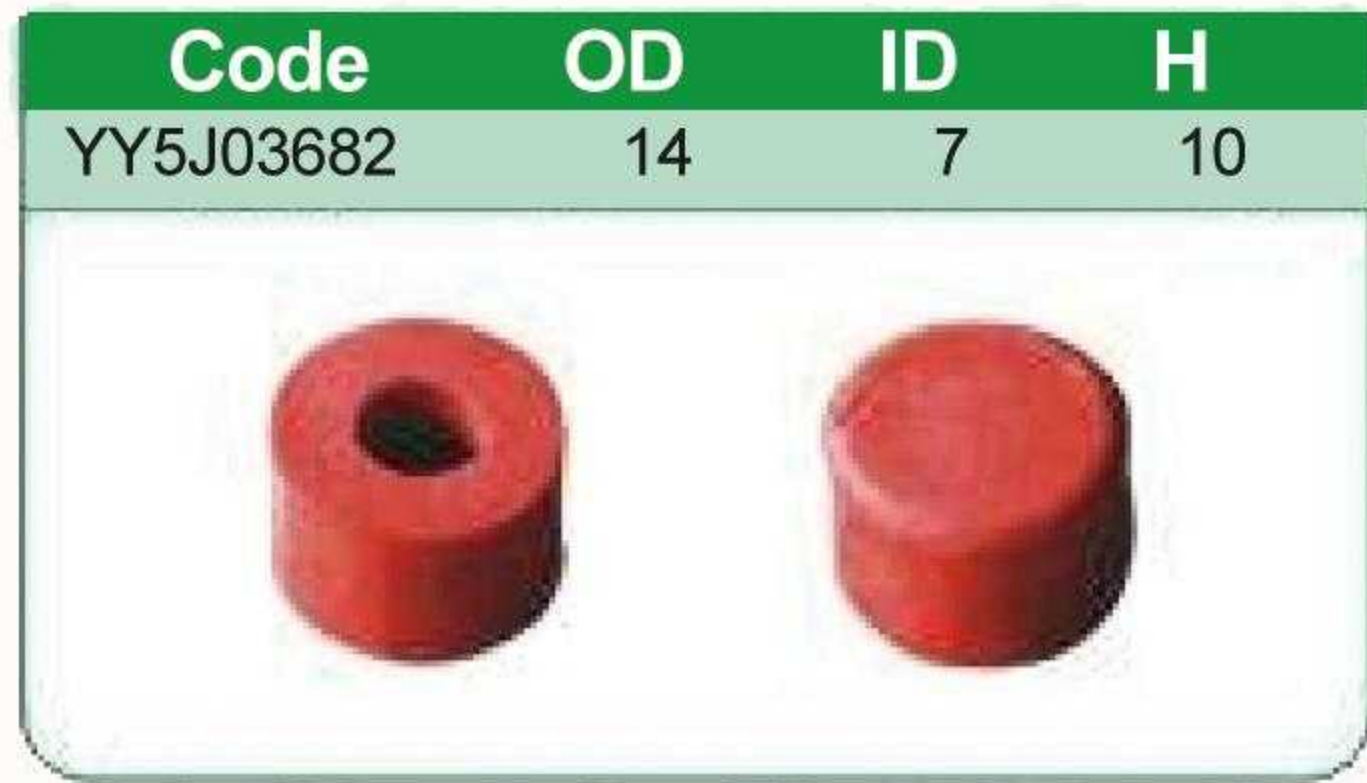
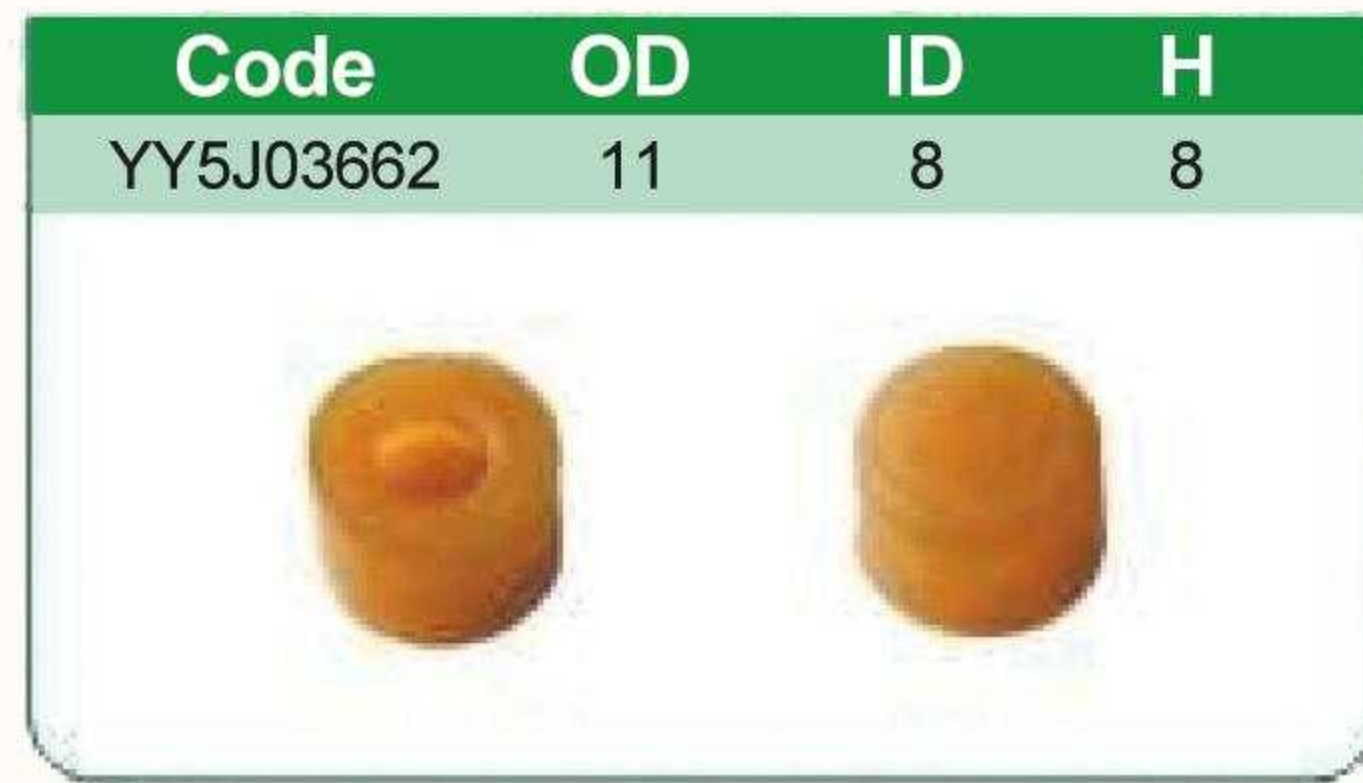

ALL THE SIZES CAN BE CUSTOMIZED.



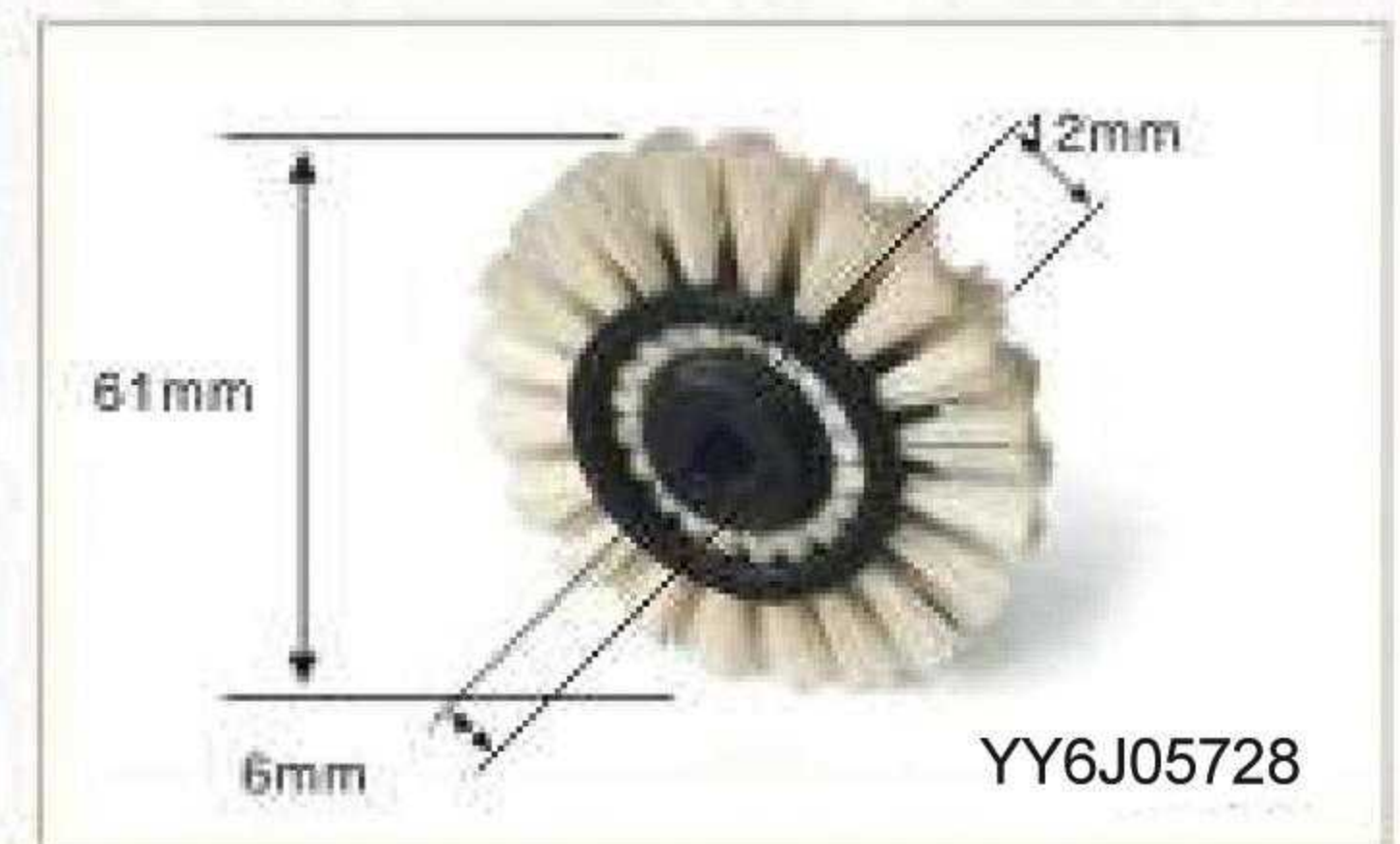
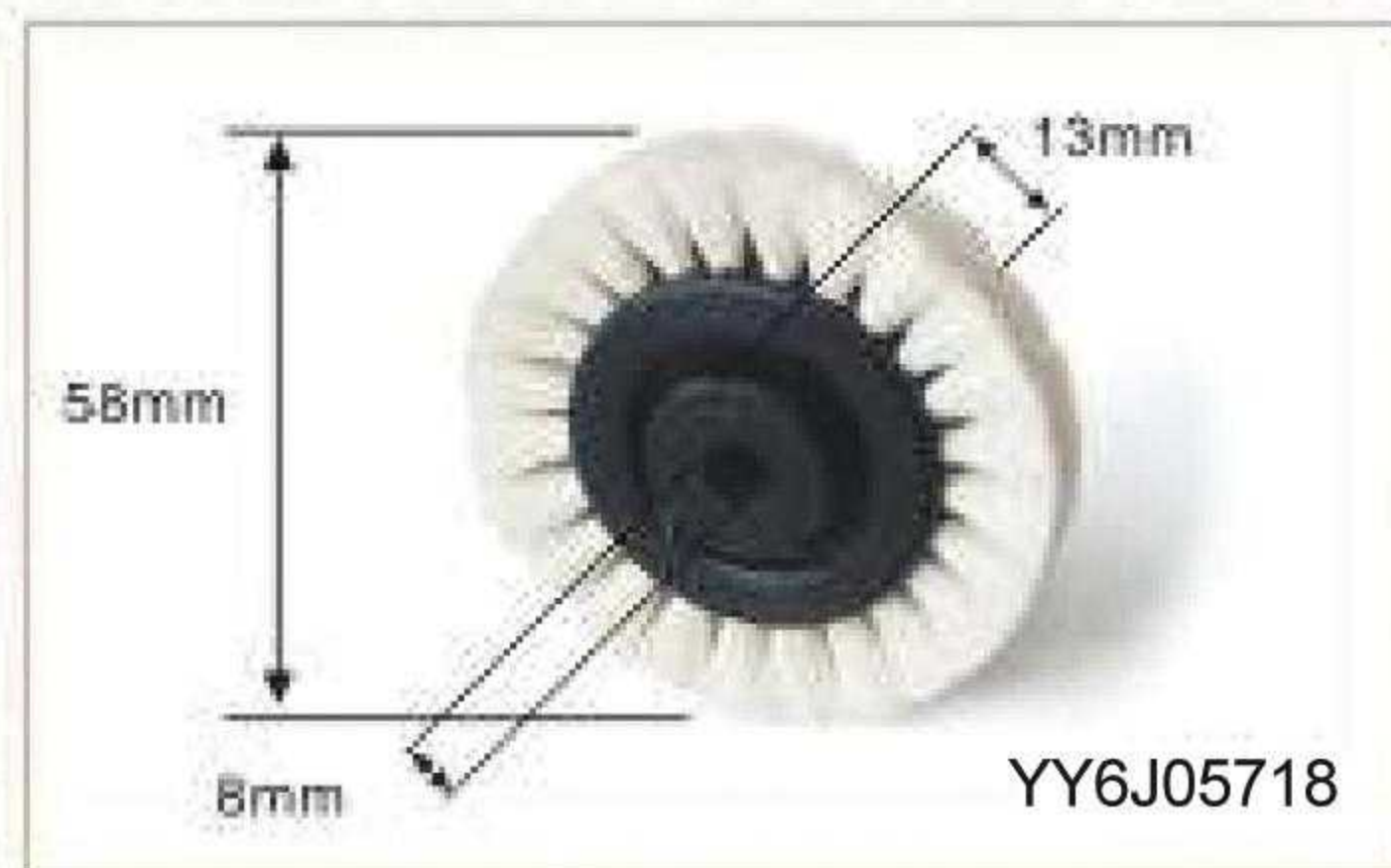
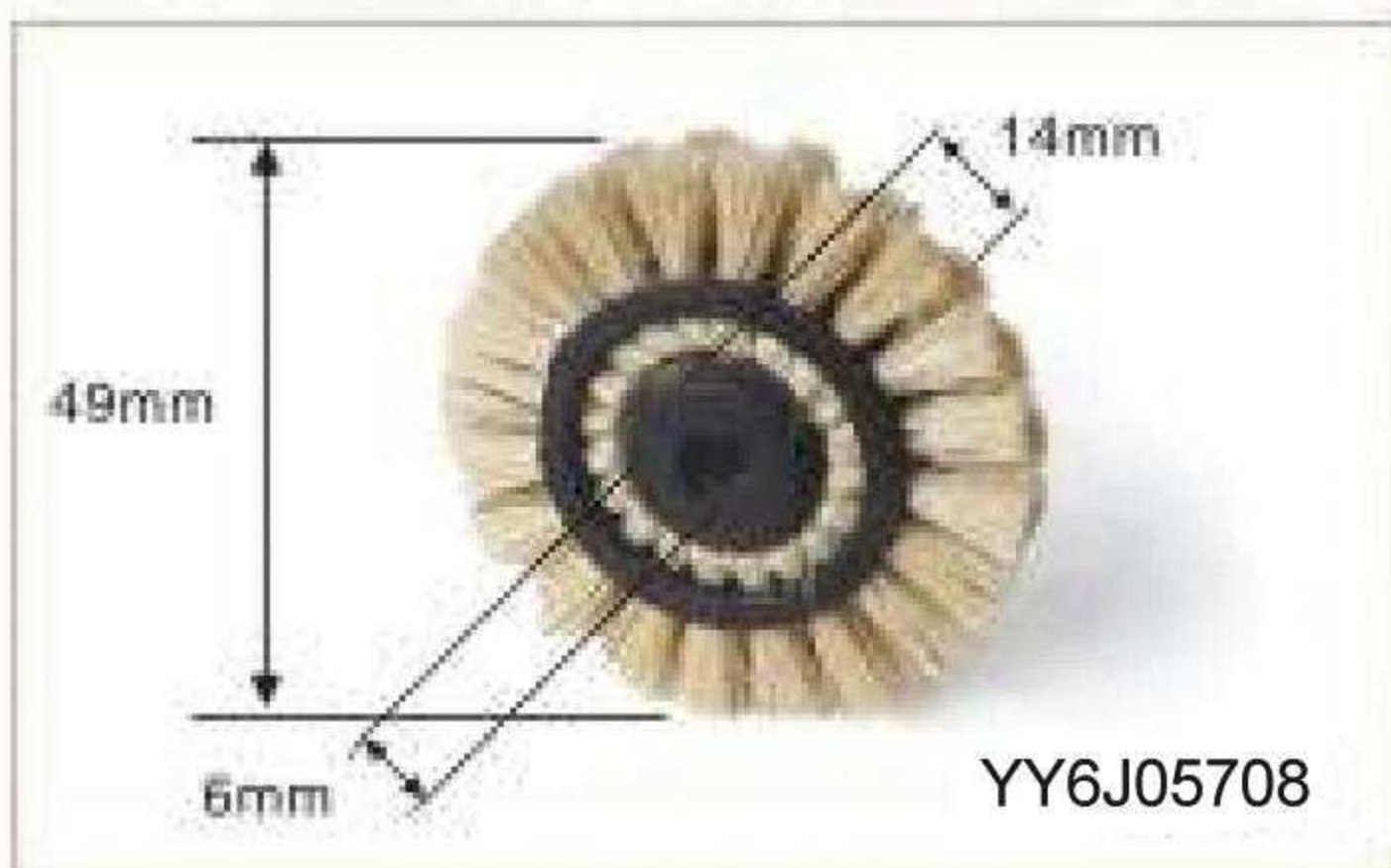
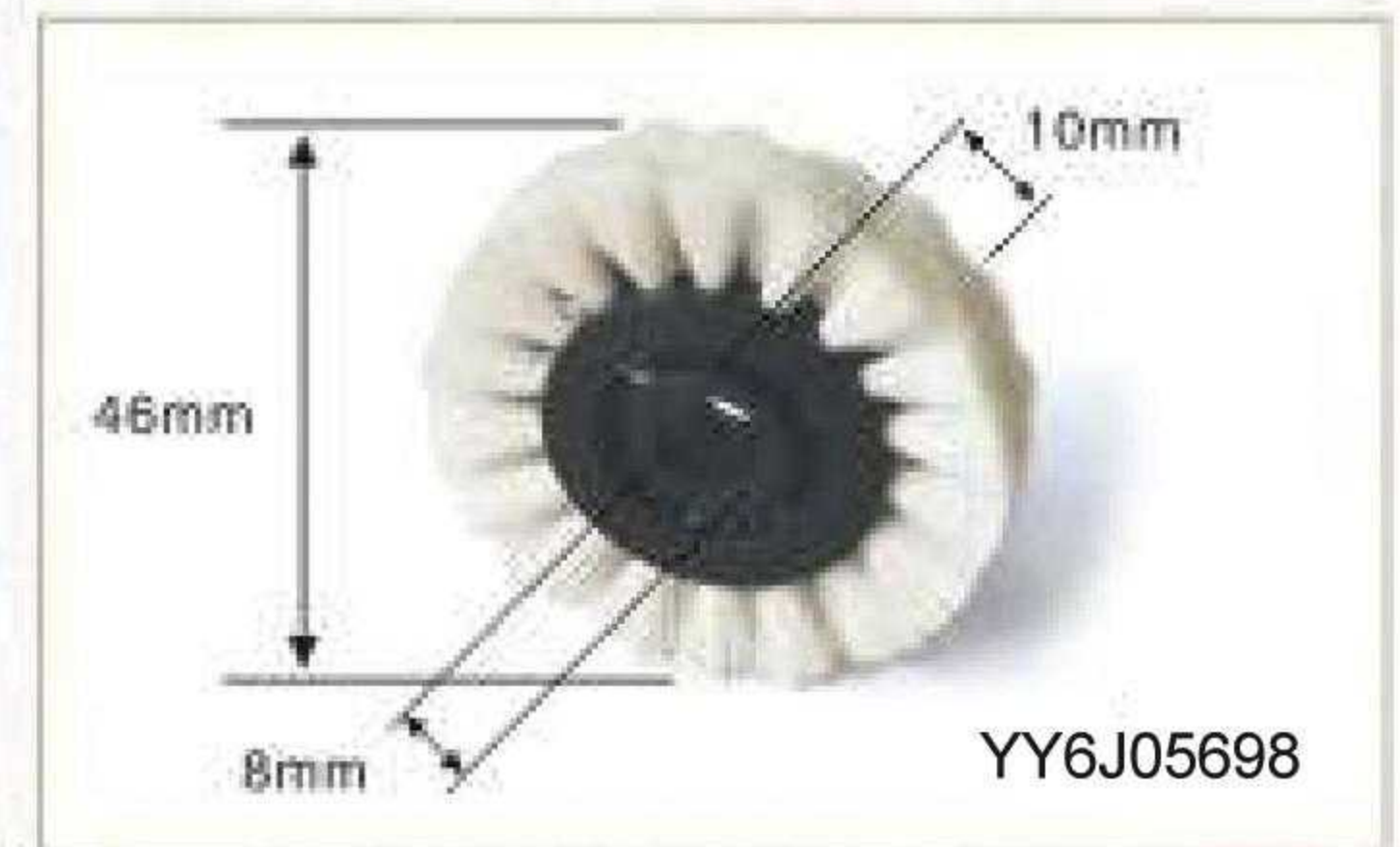
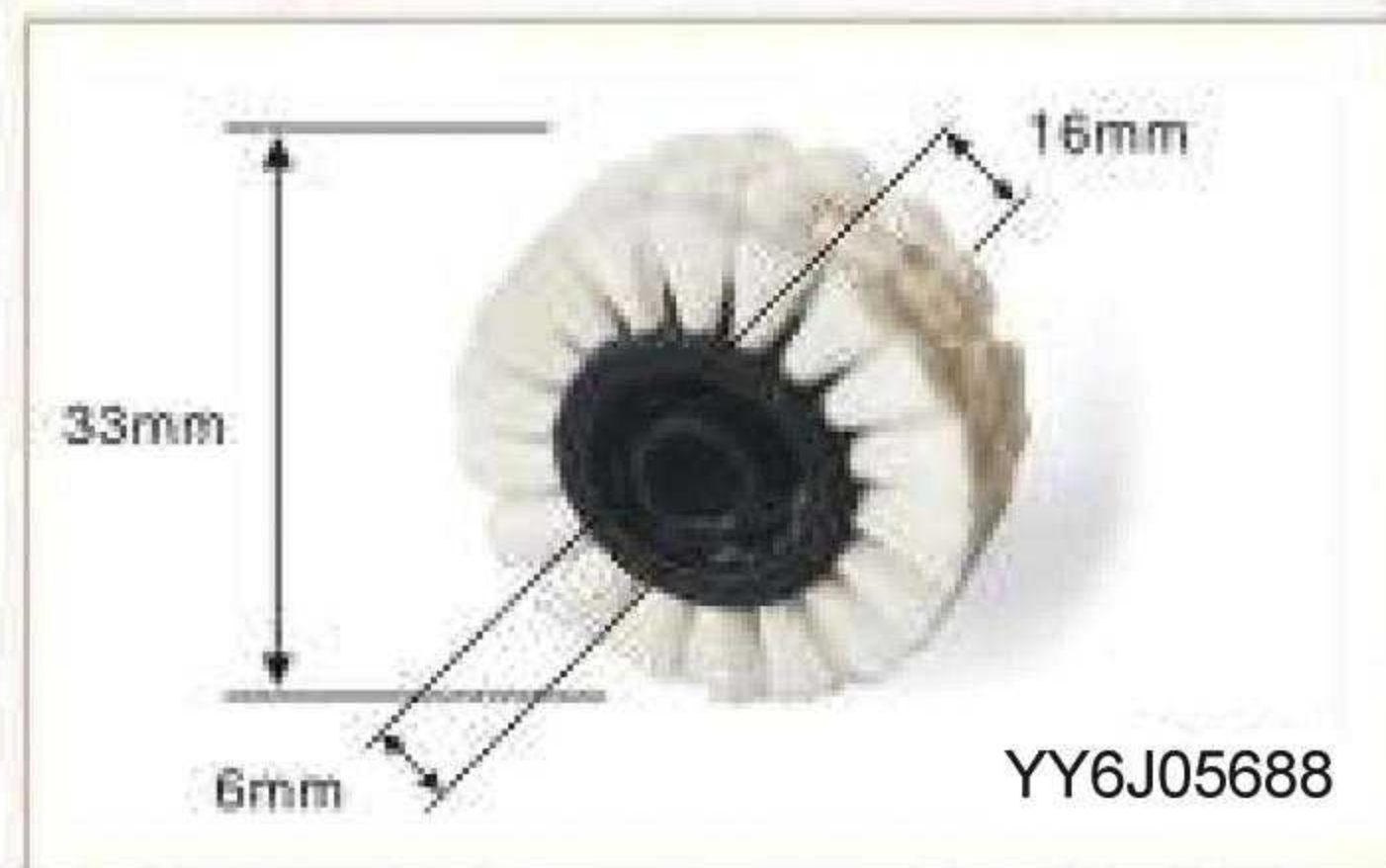
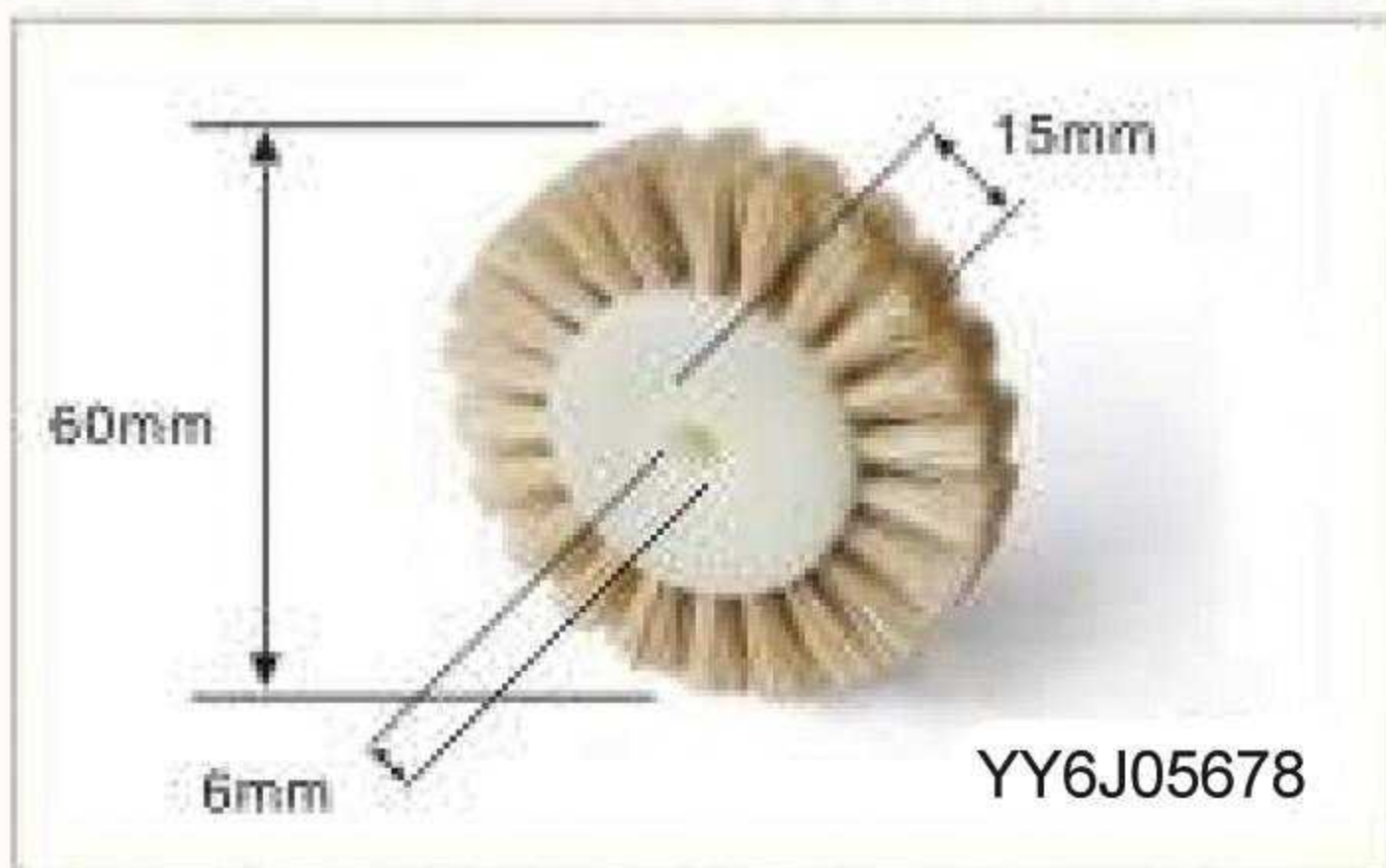
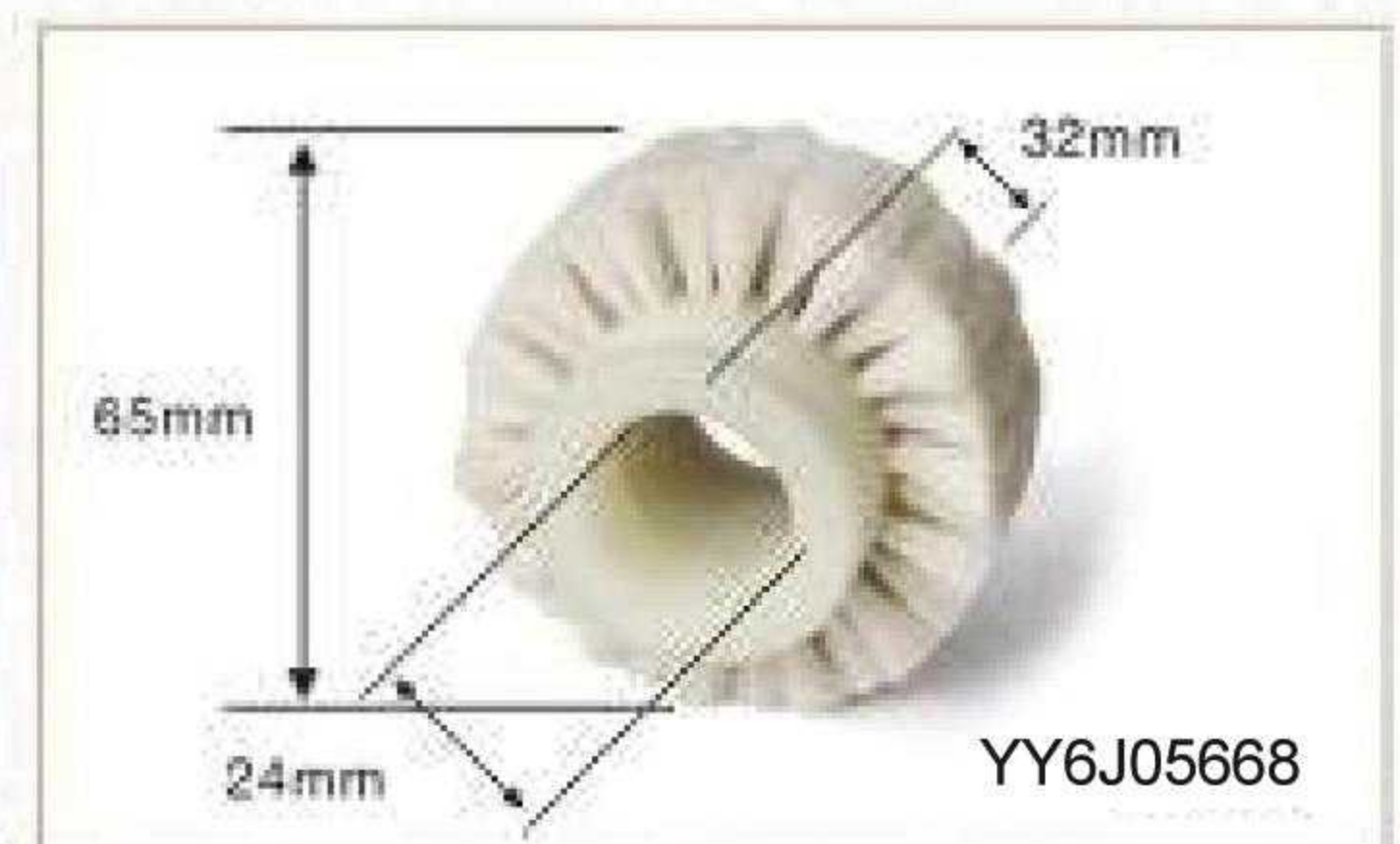
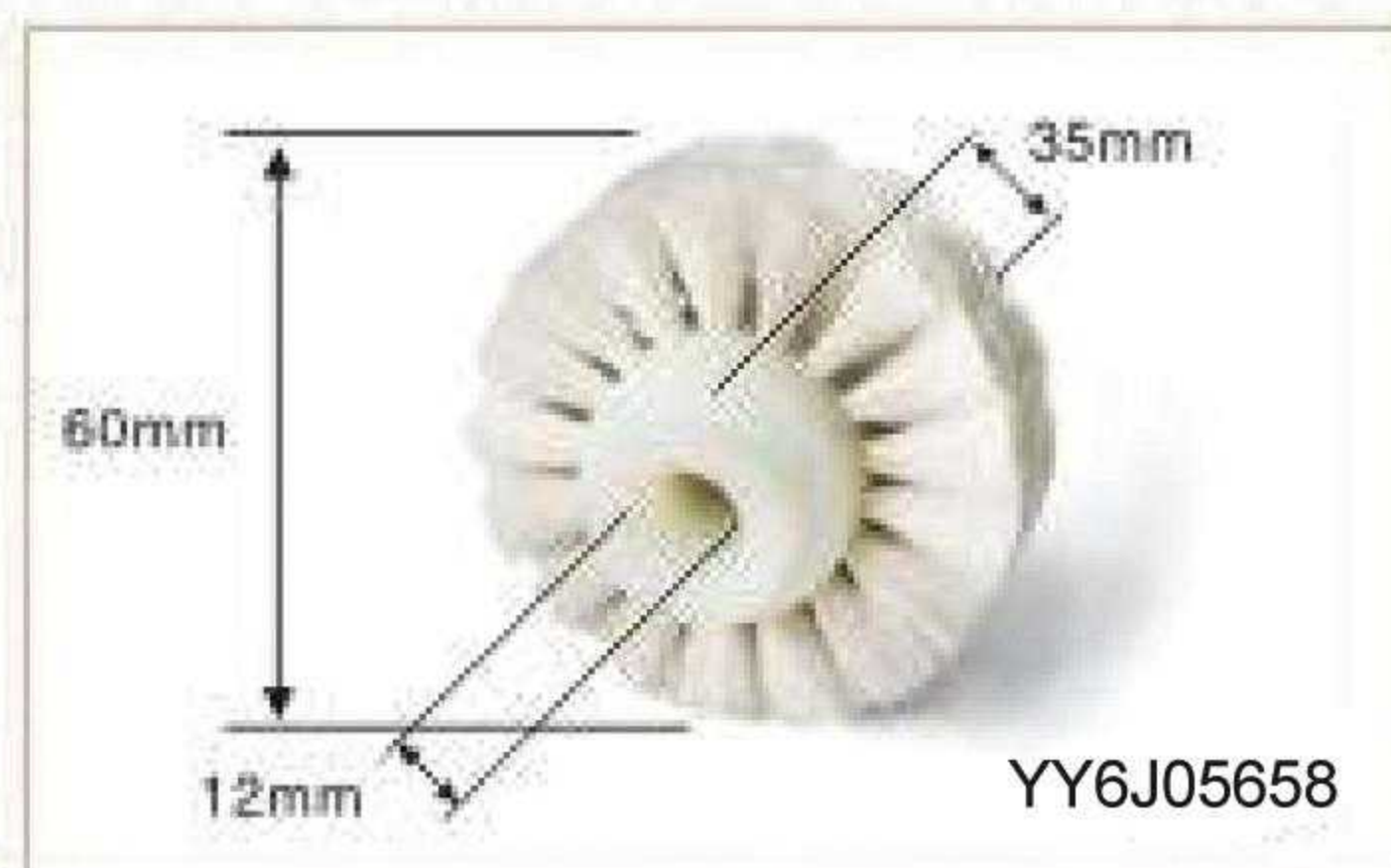
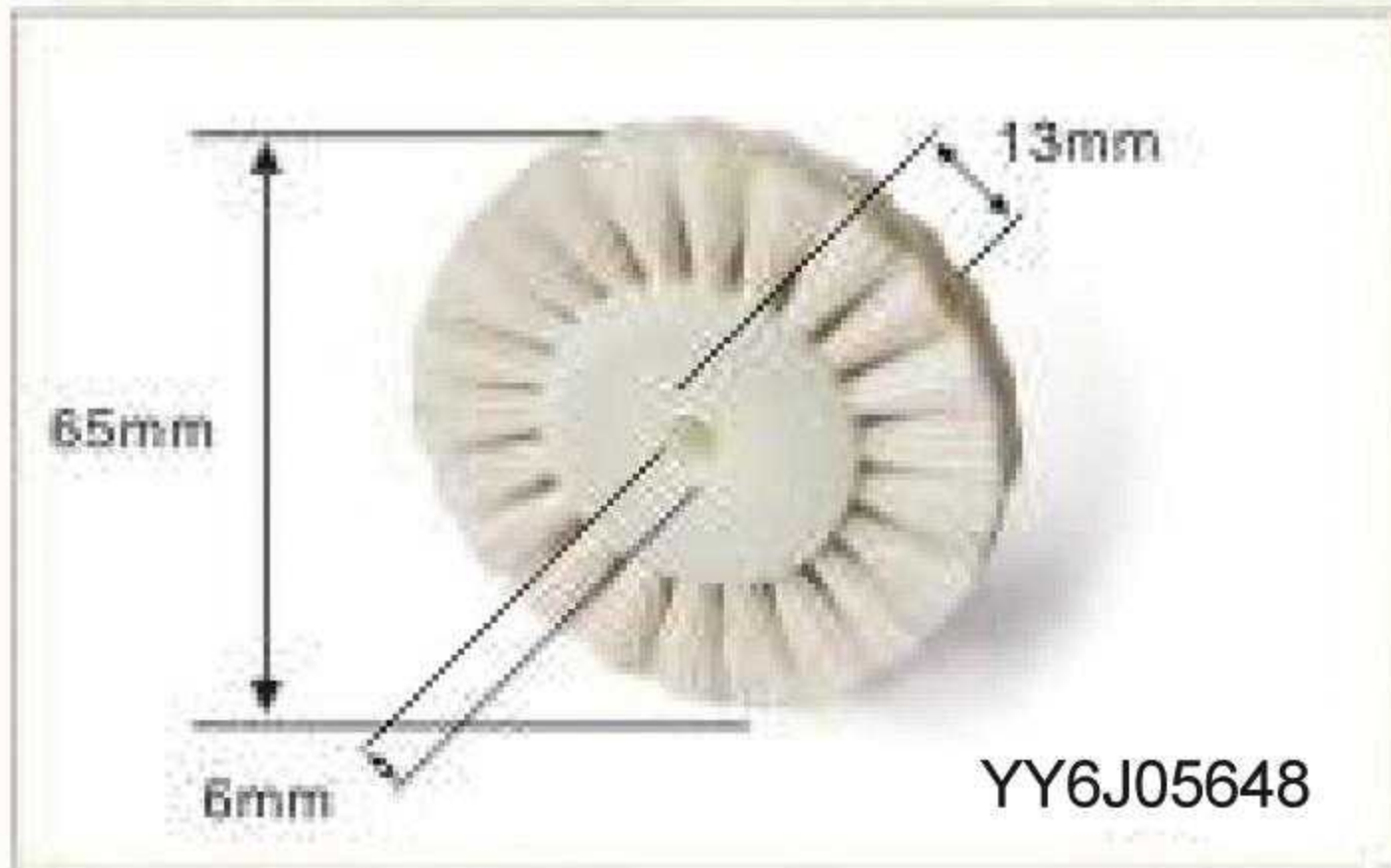
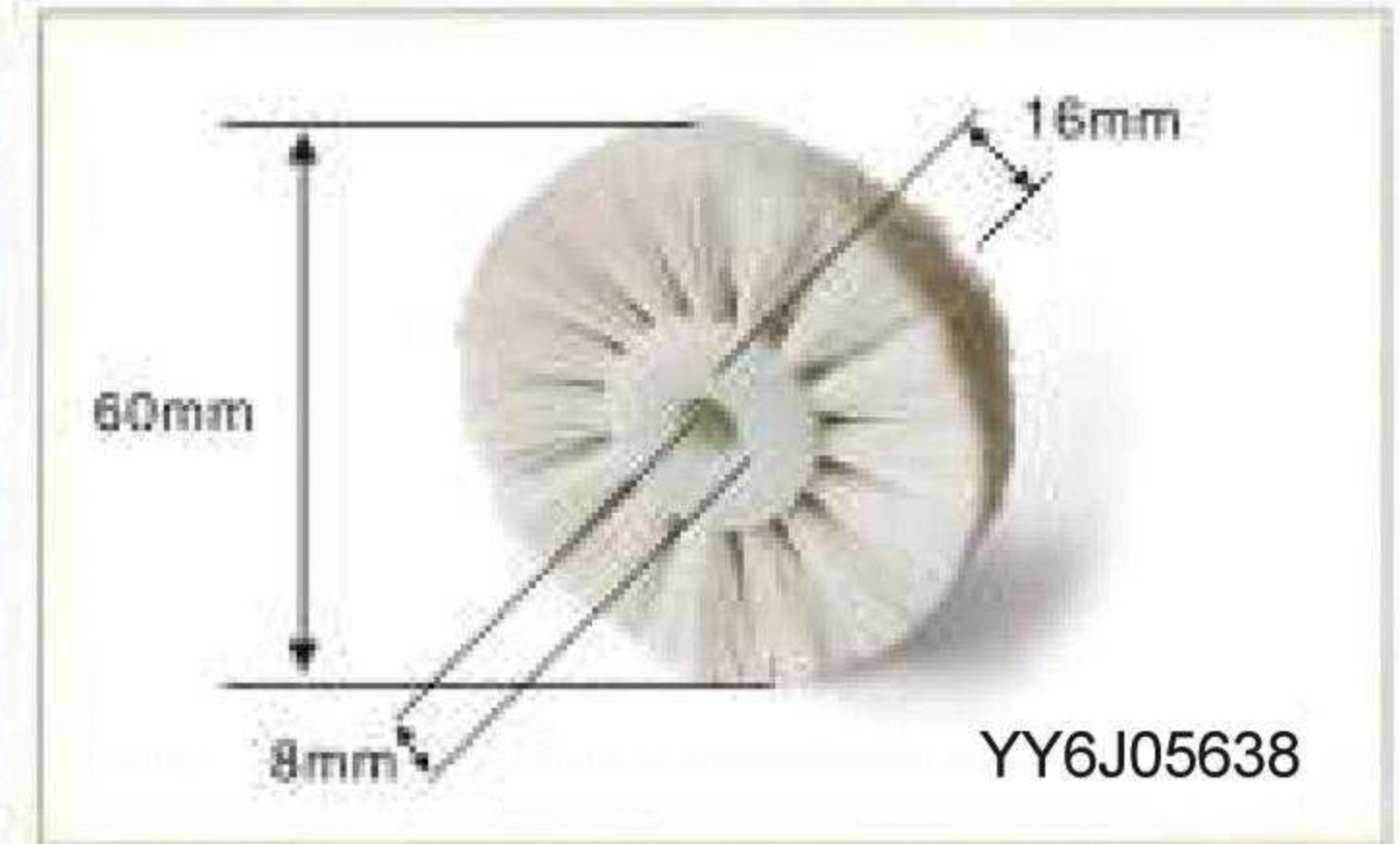
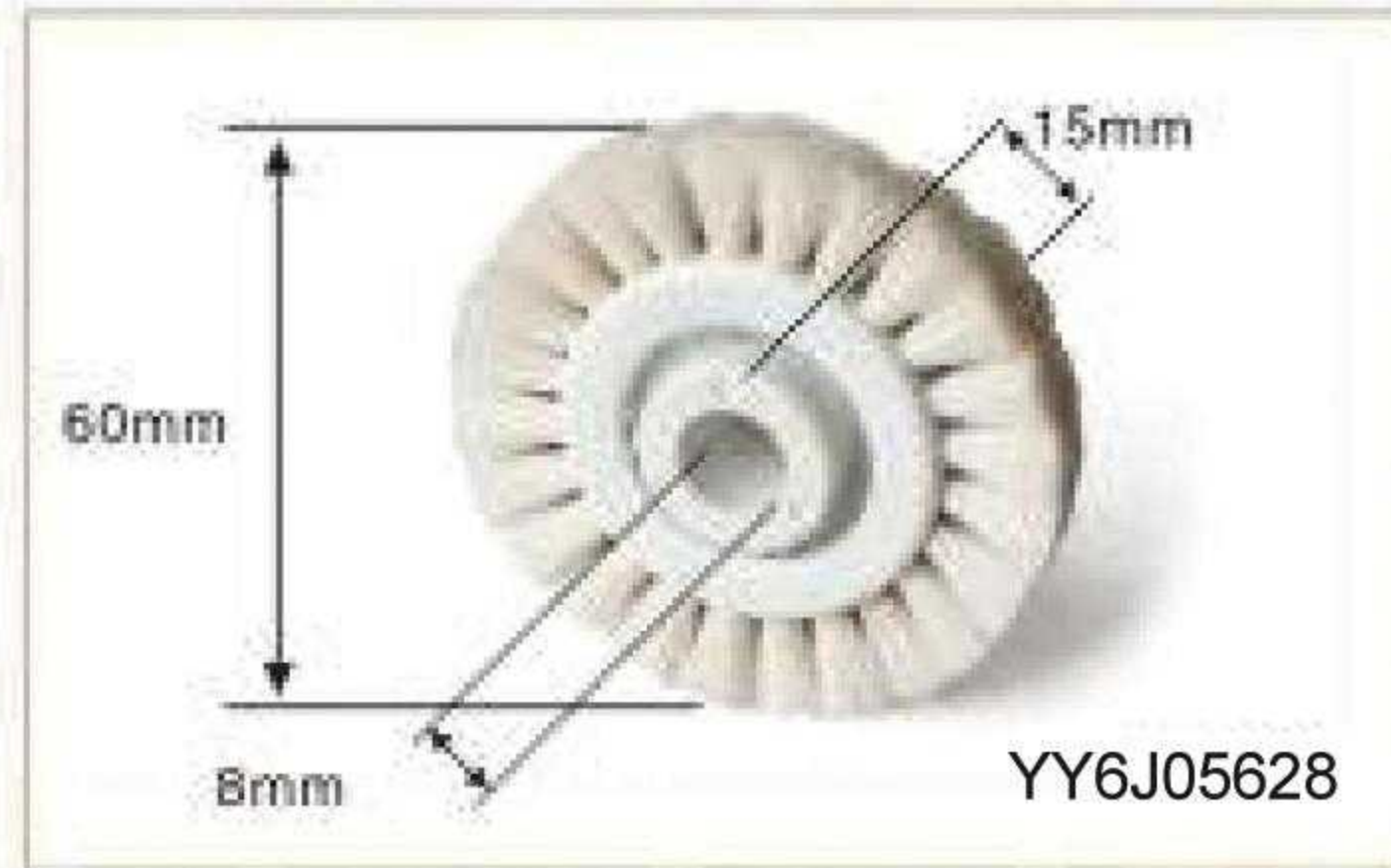
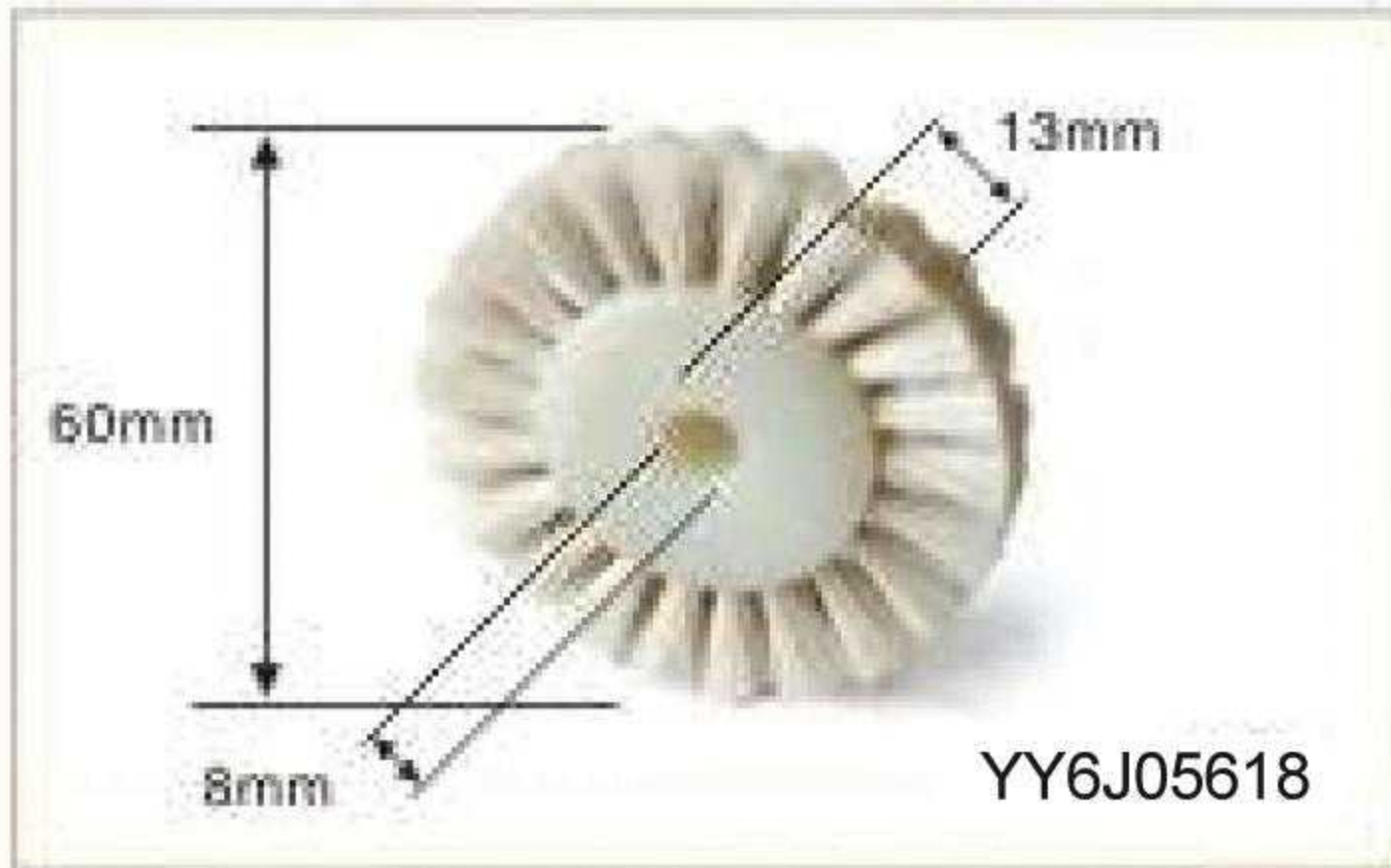
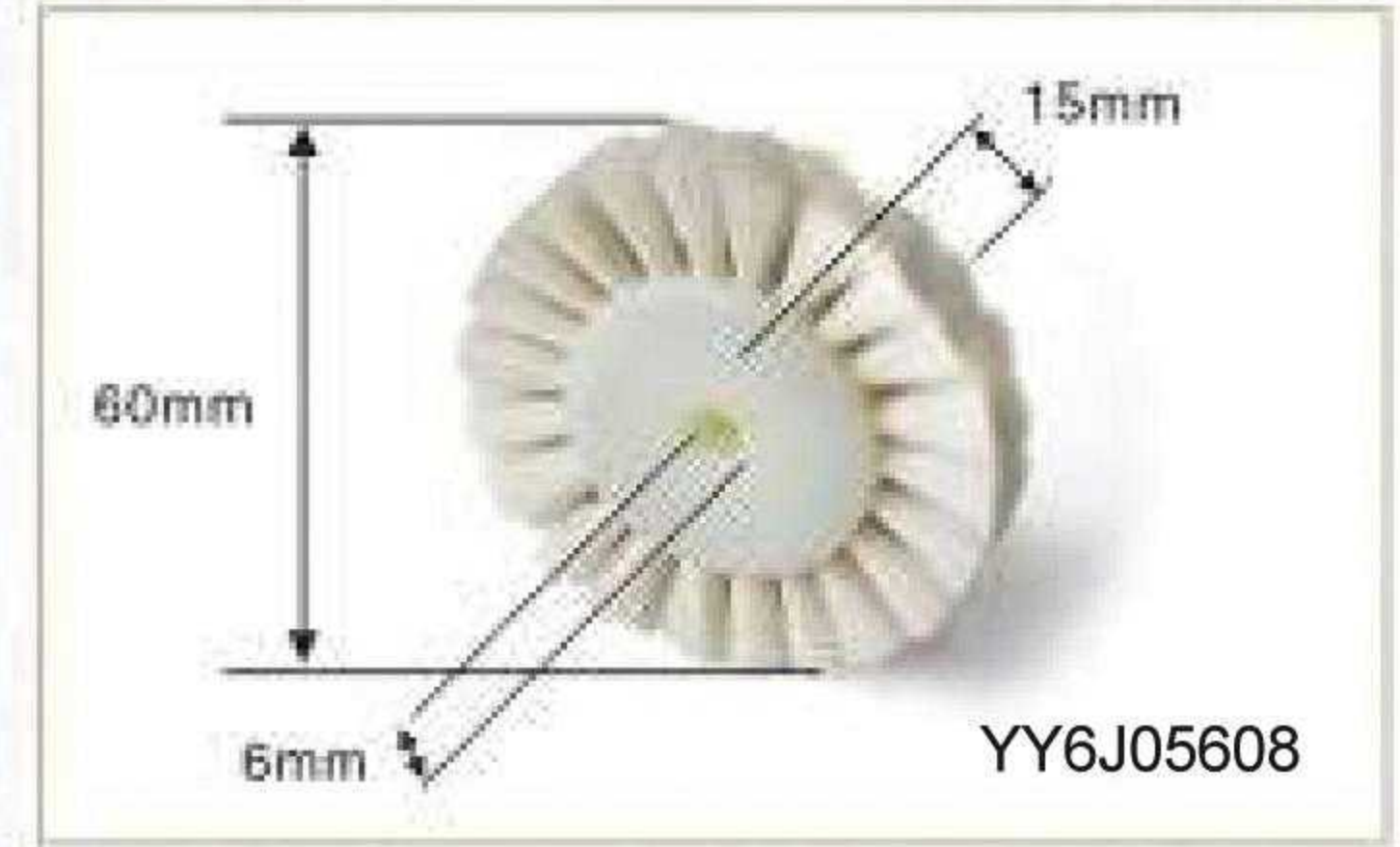
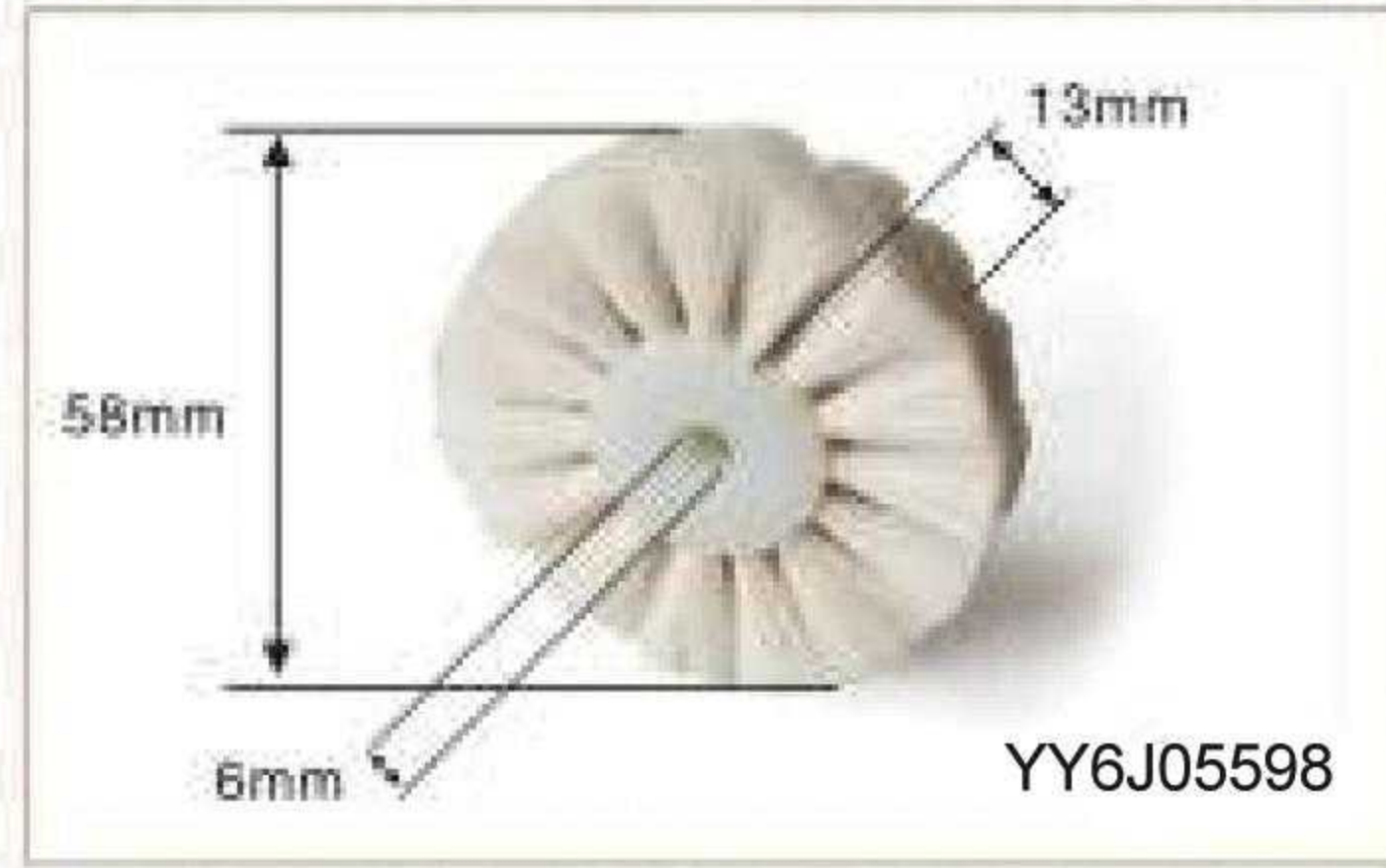
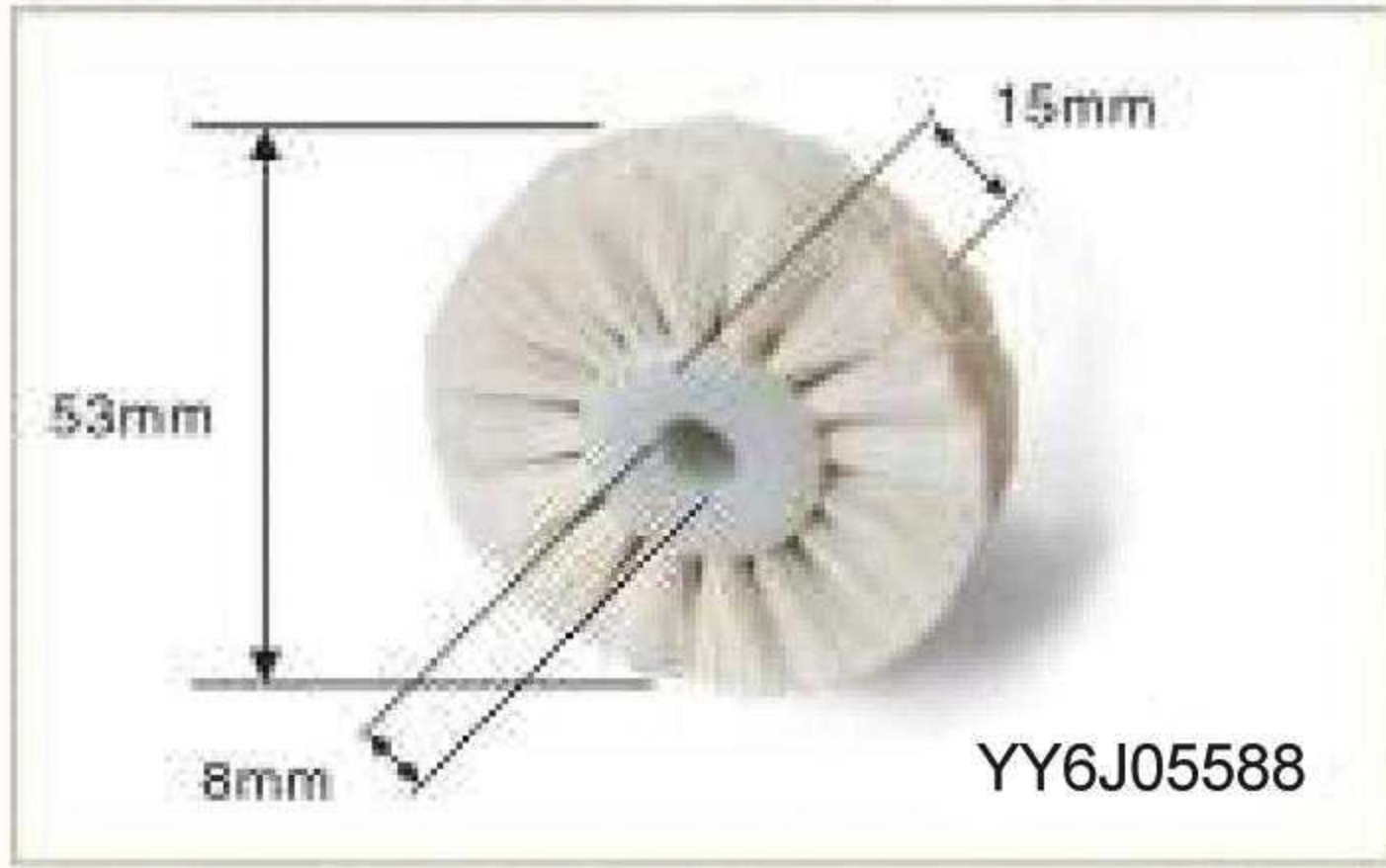
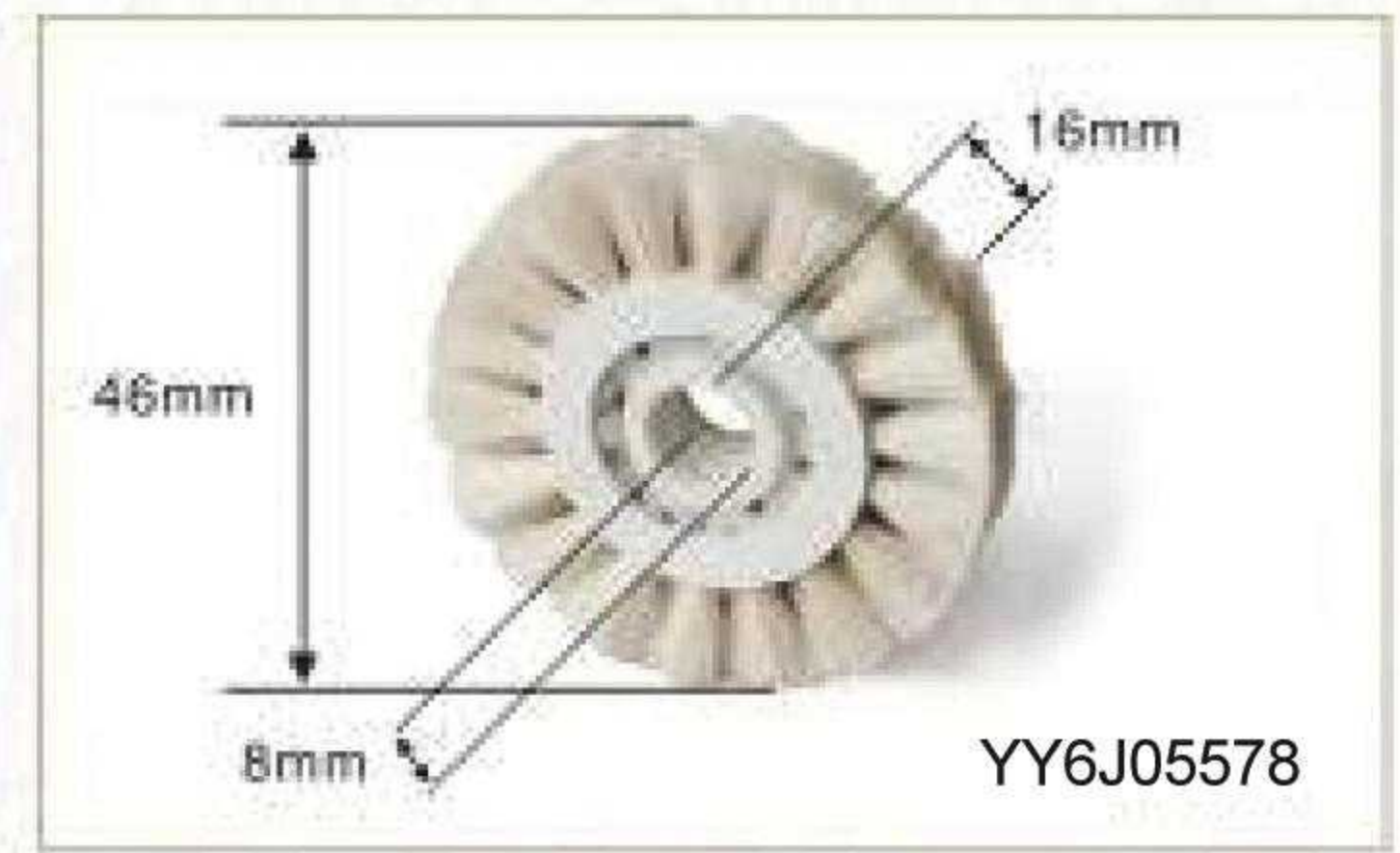
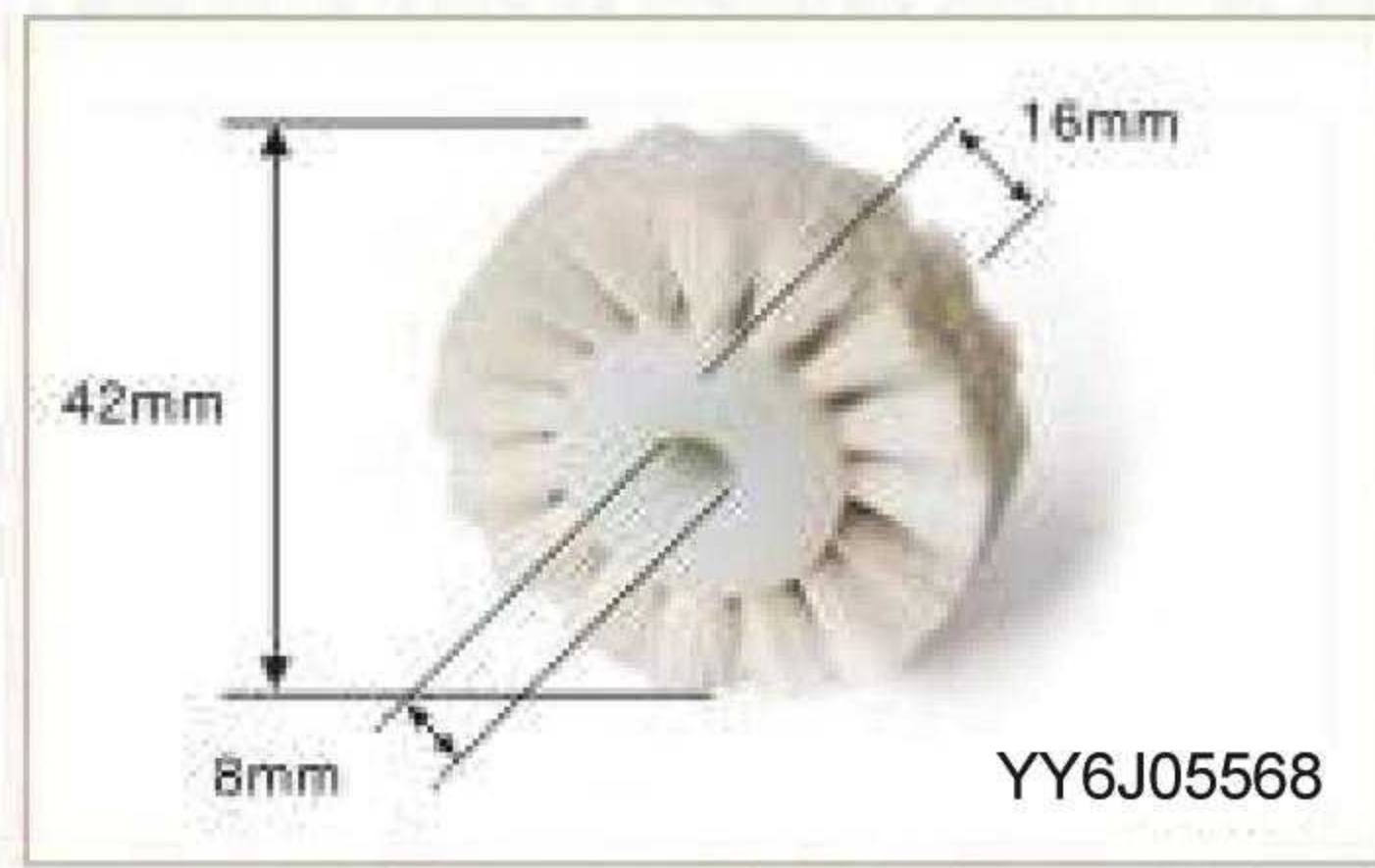
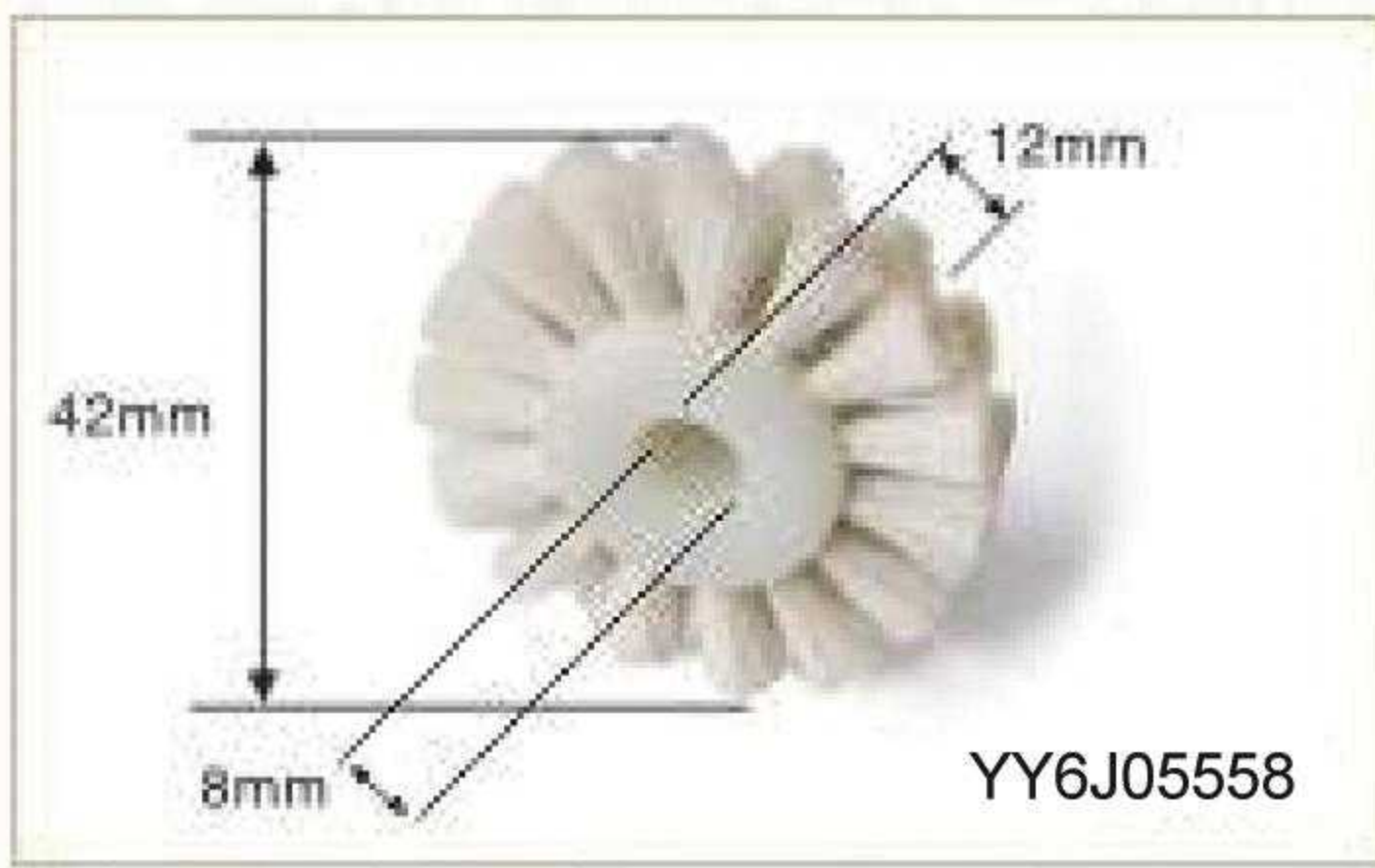

EISI® Rubber Sucker

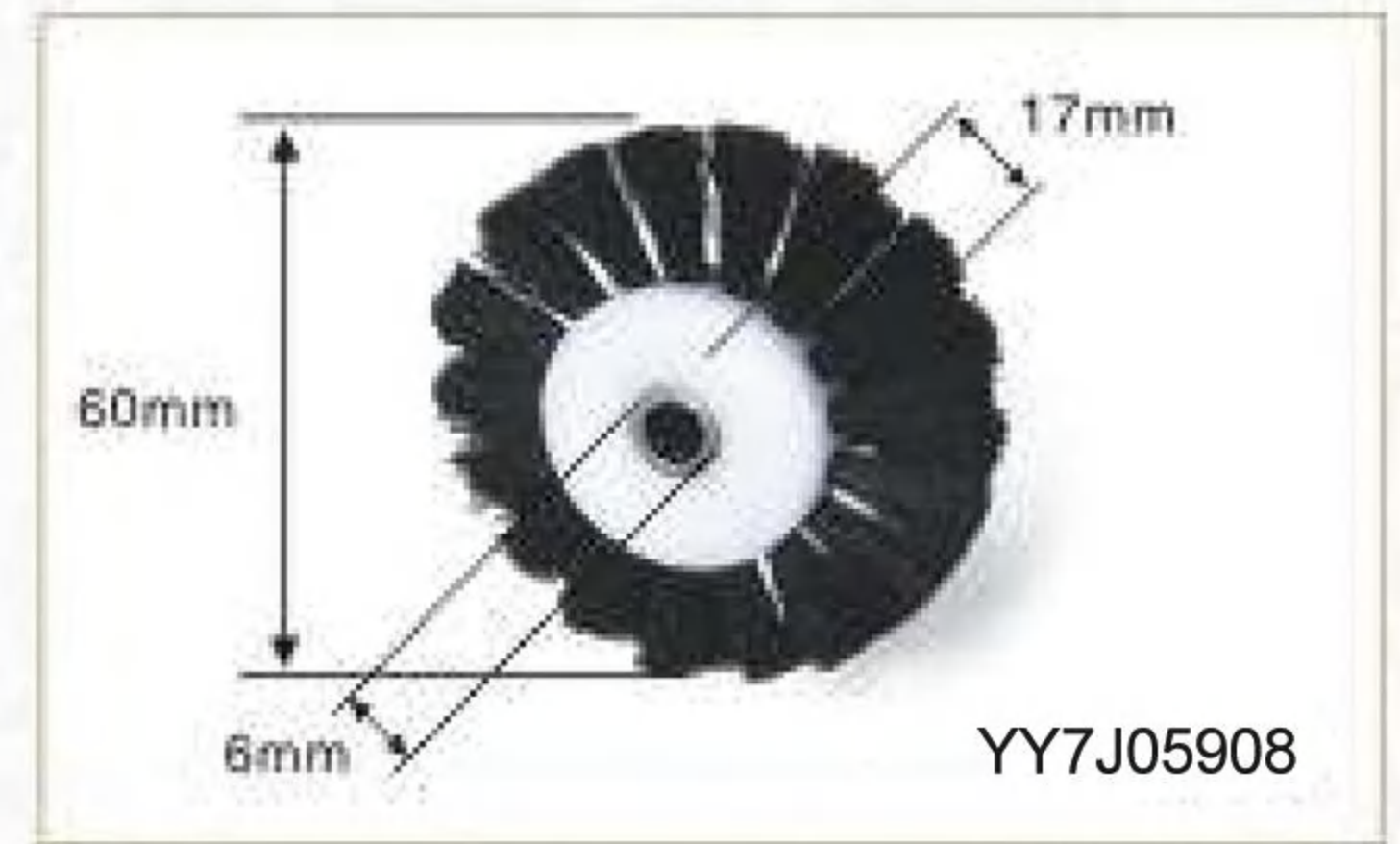
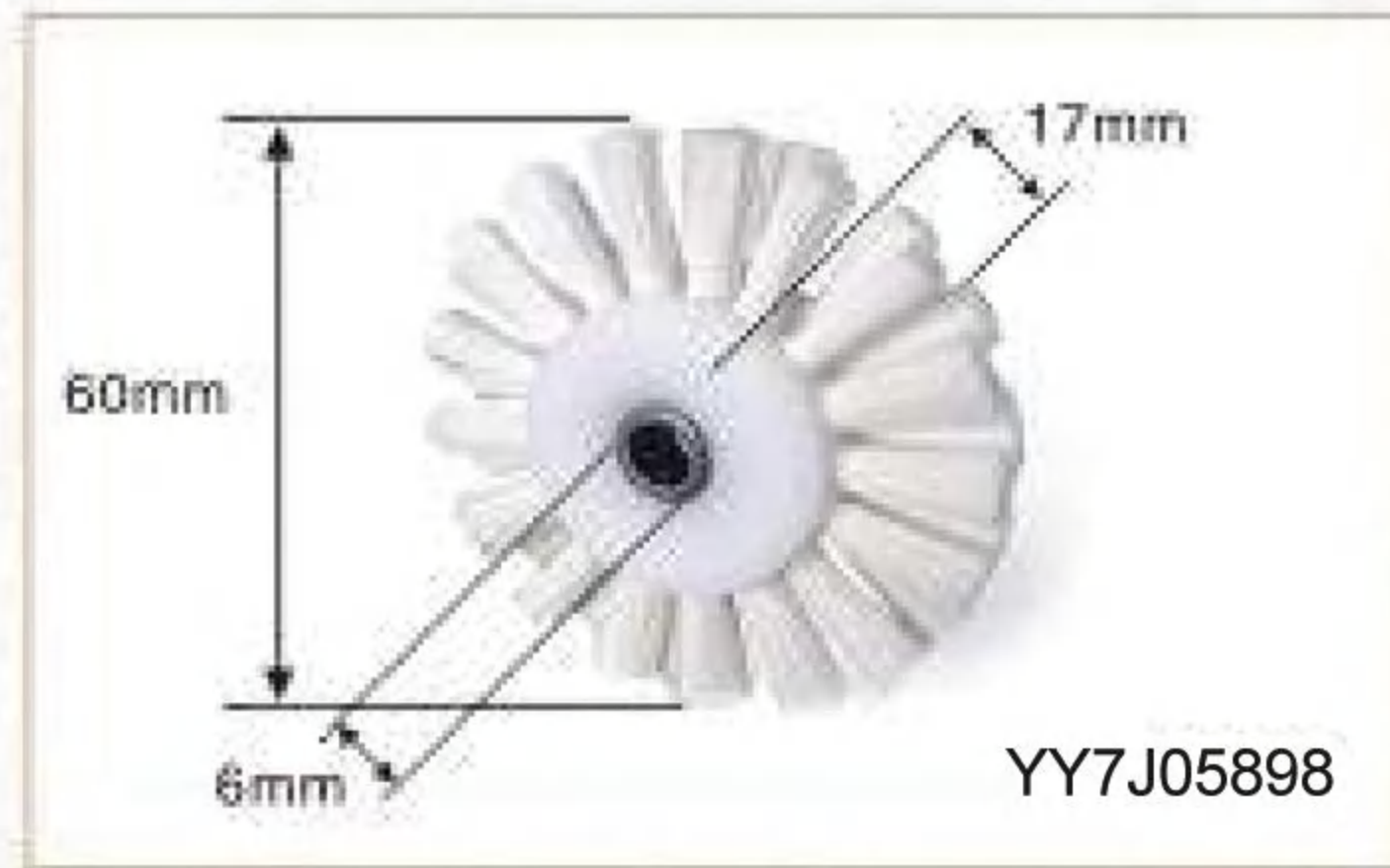
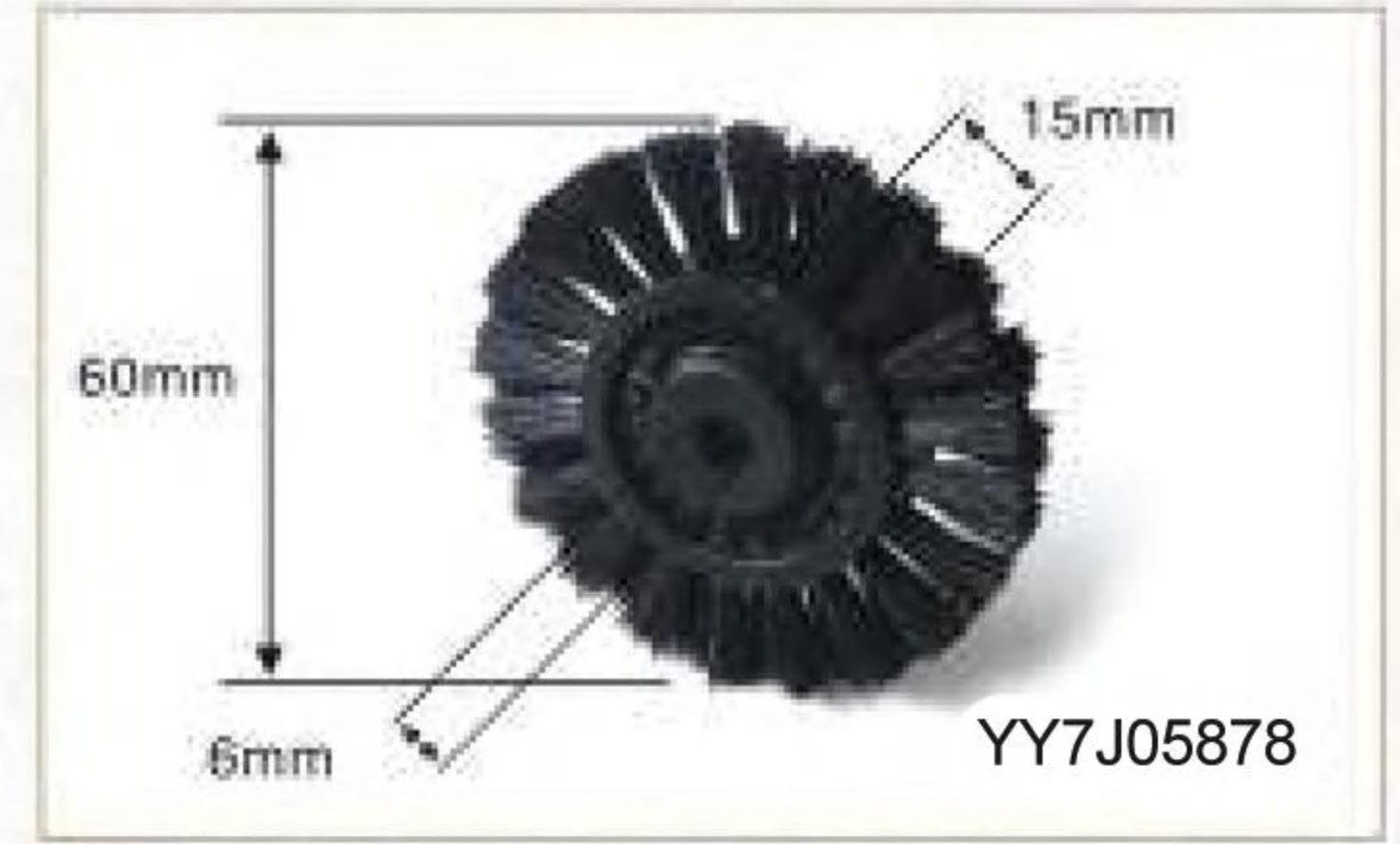
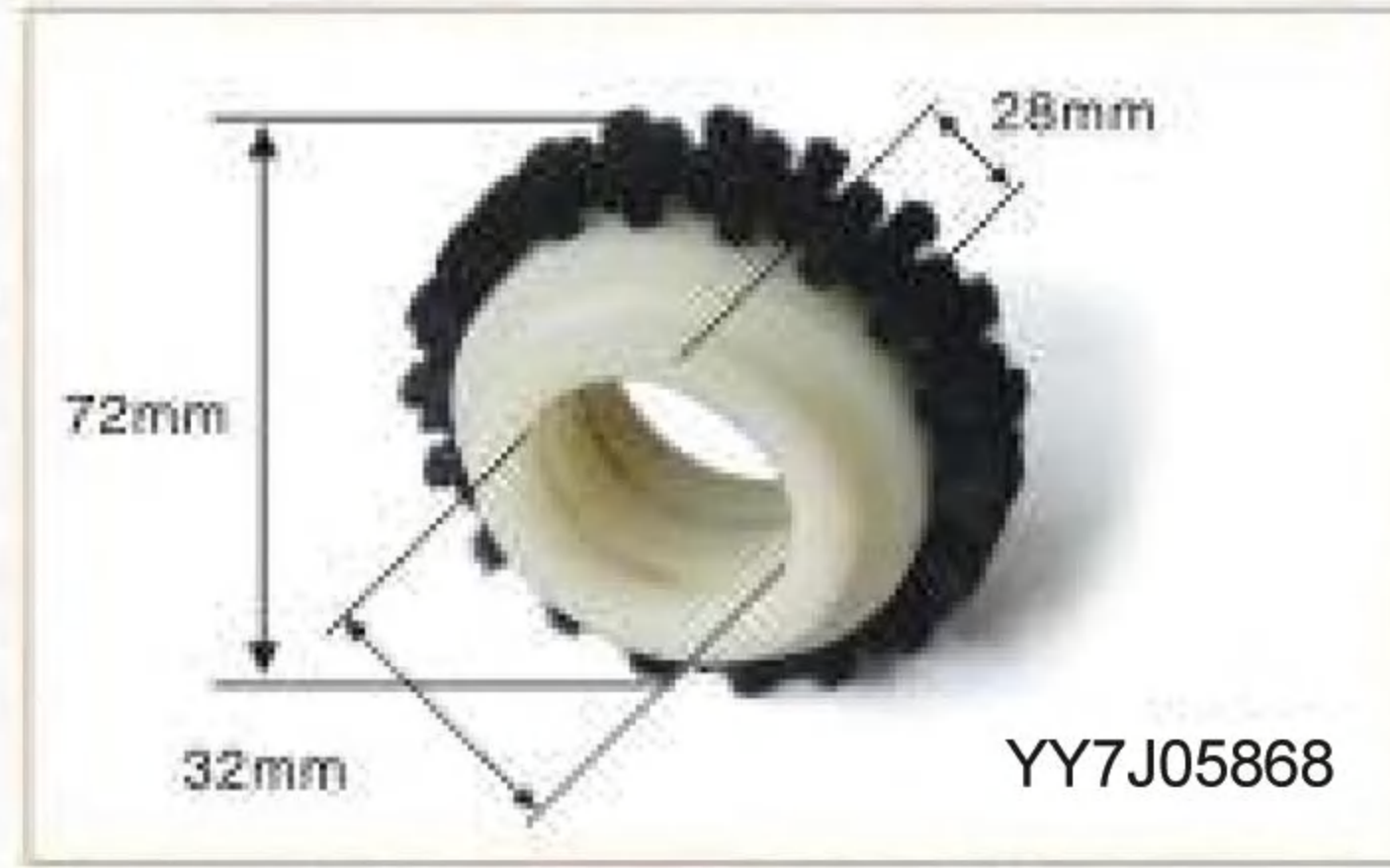
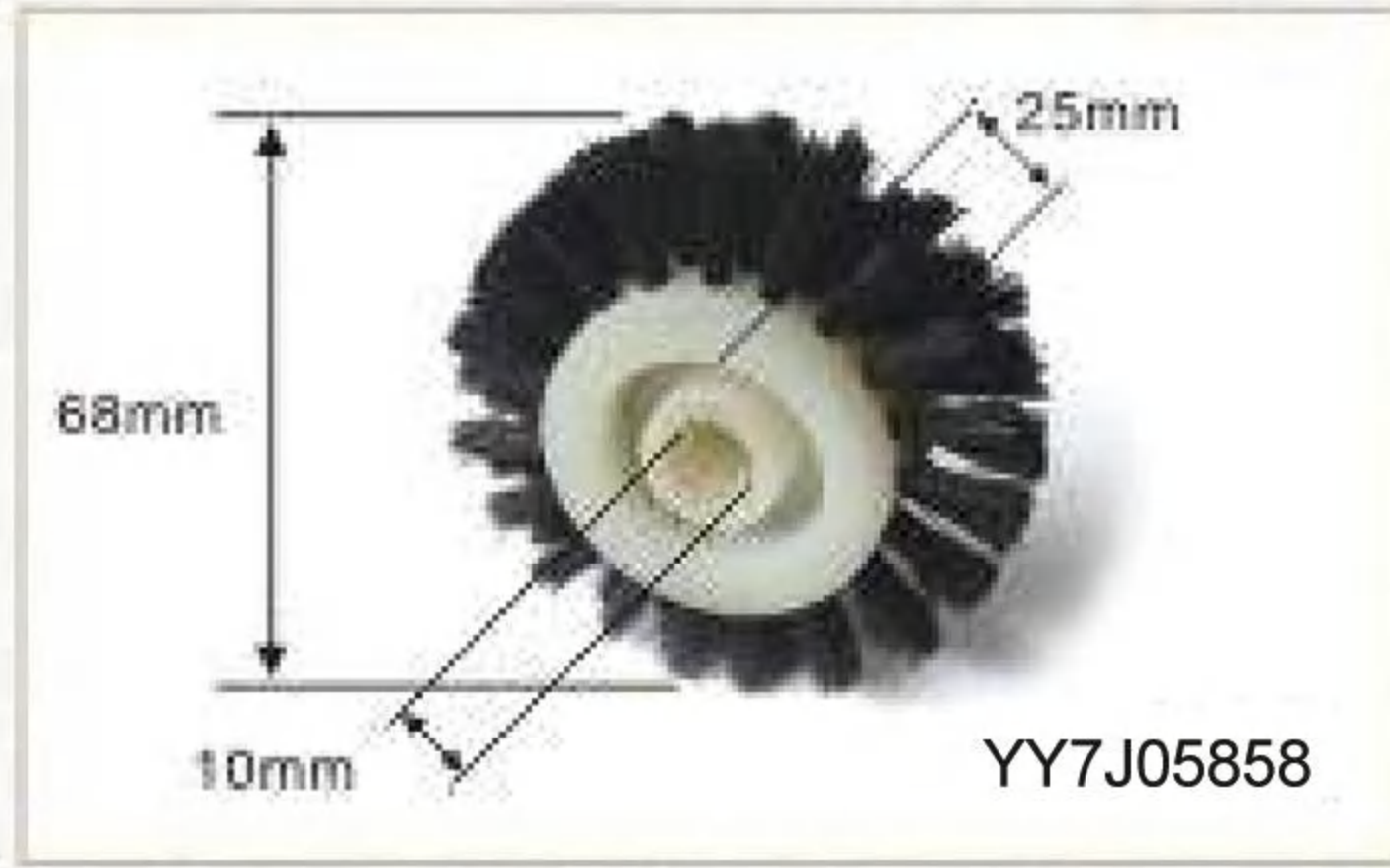
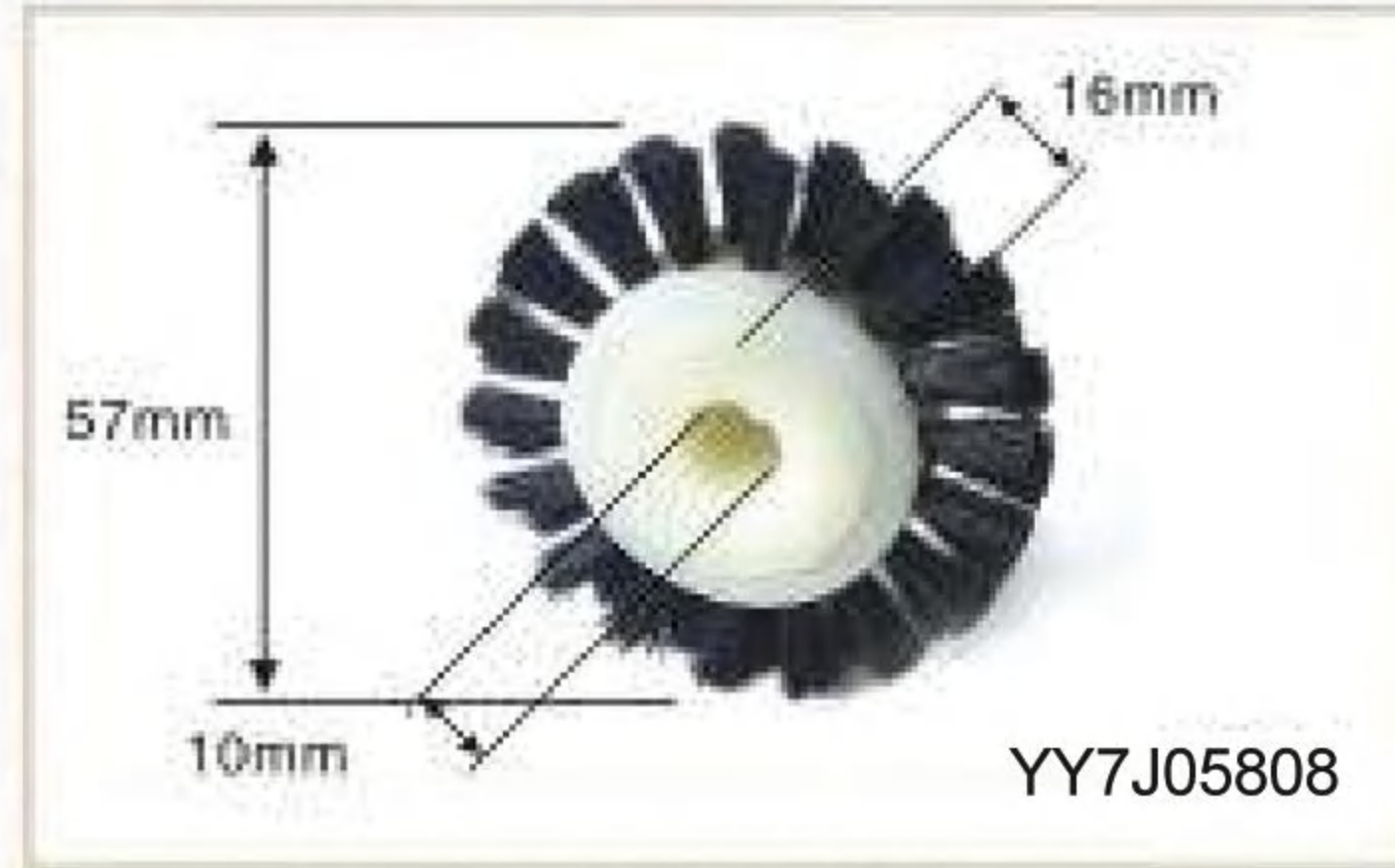
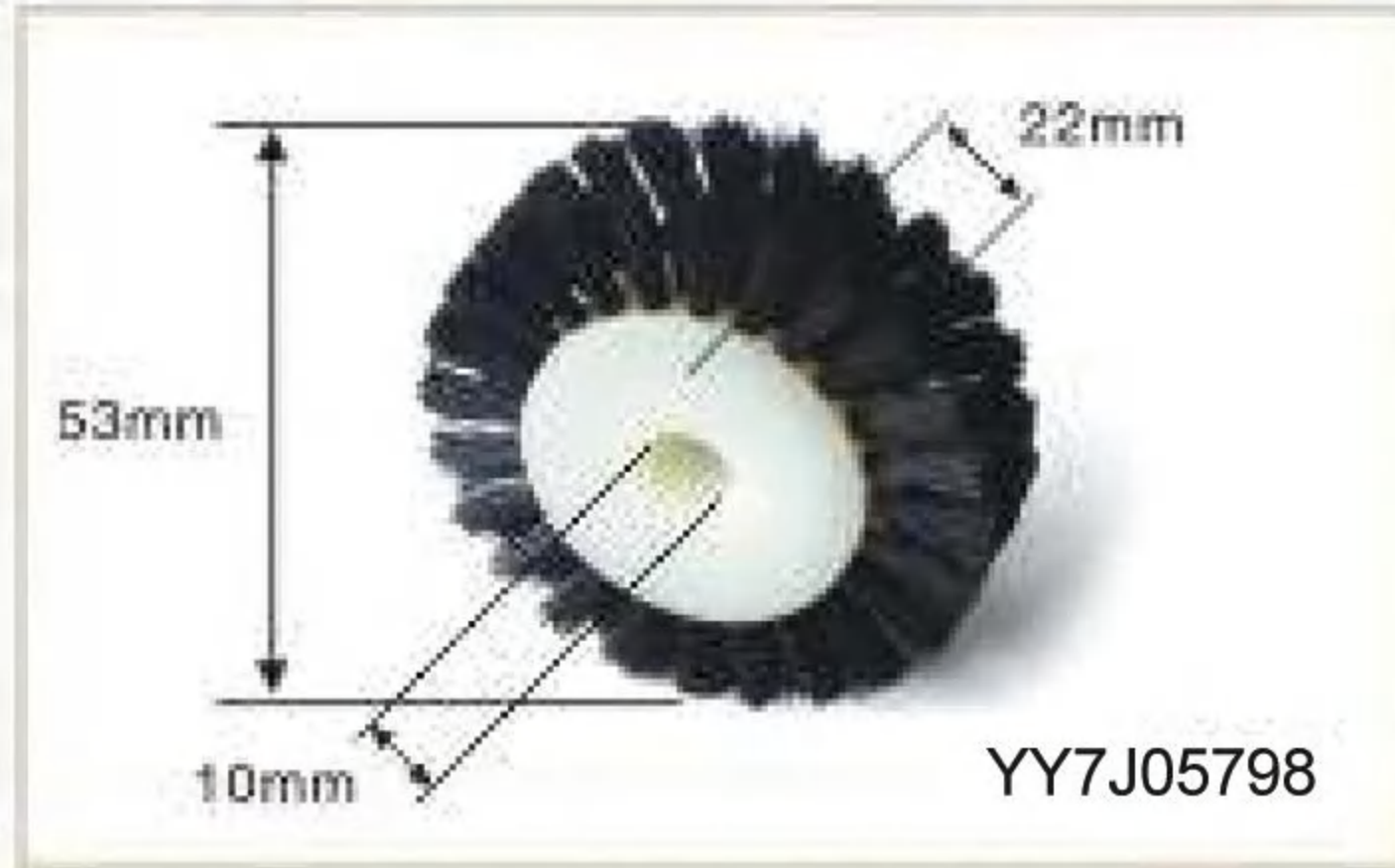
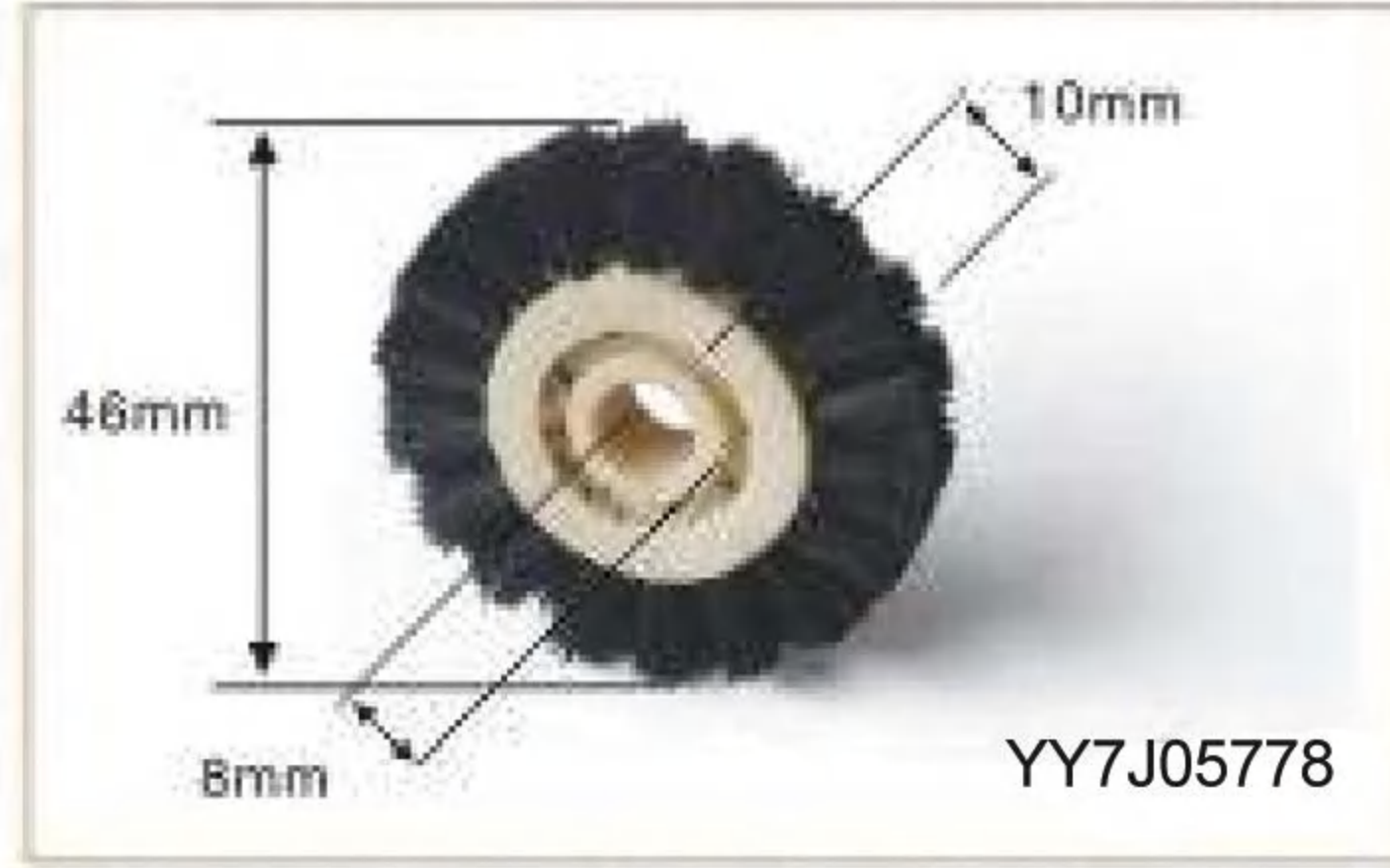
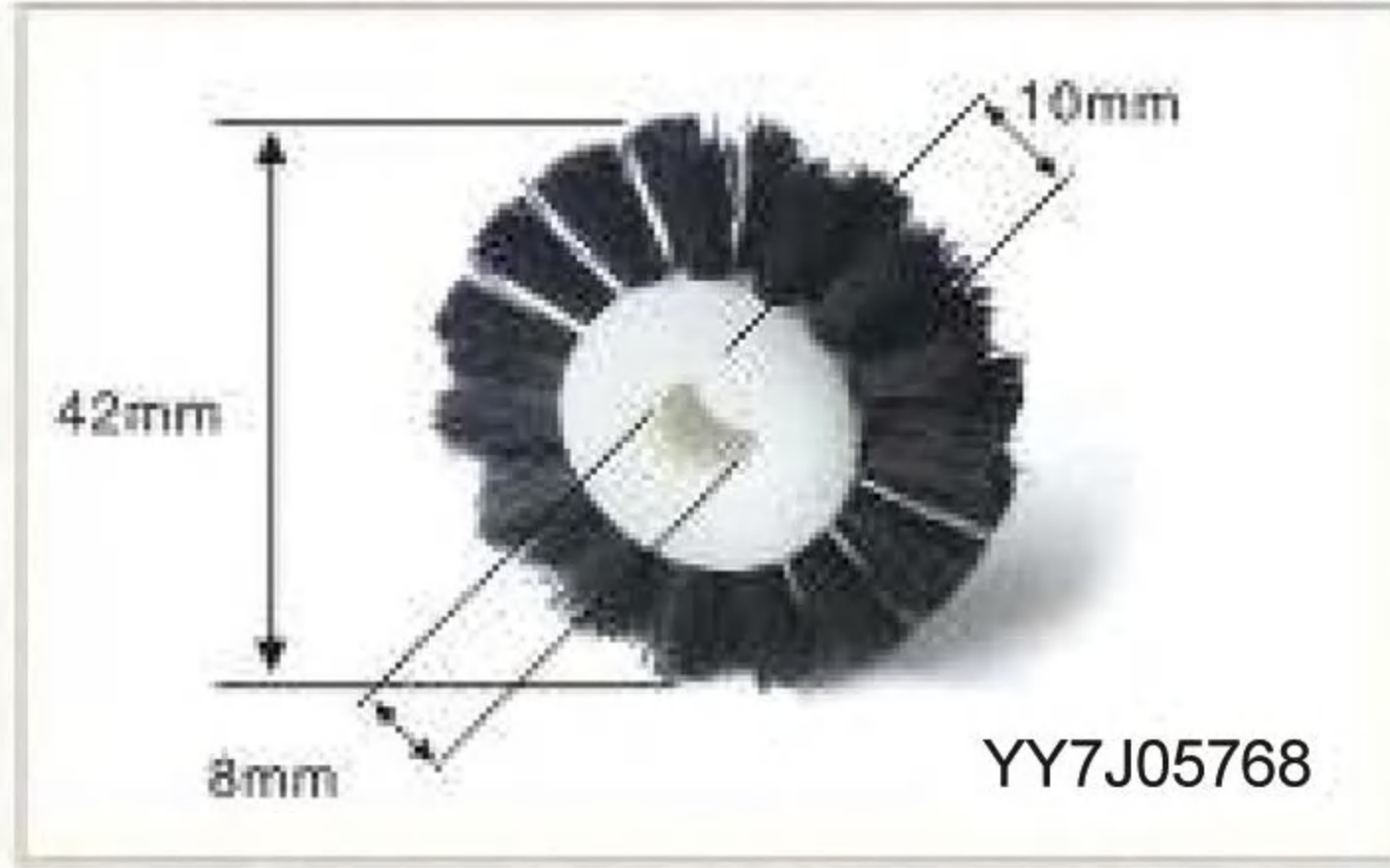
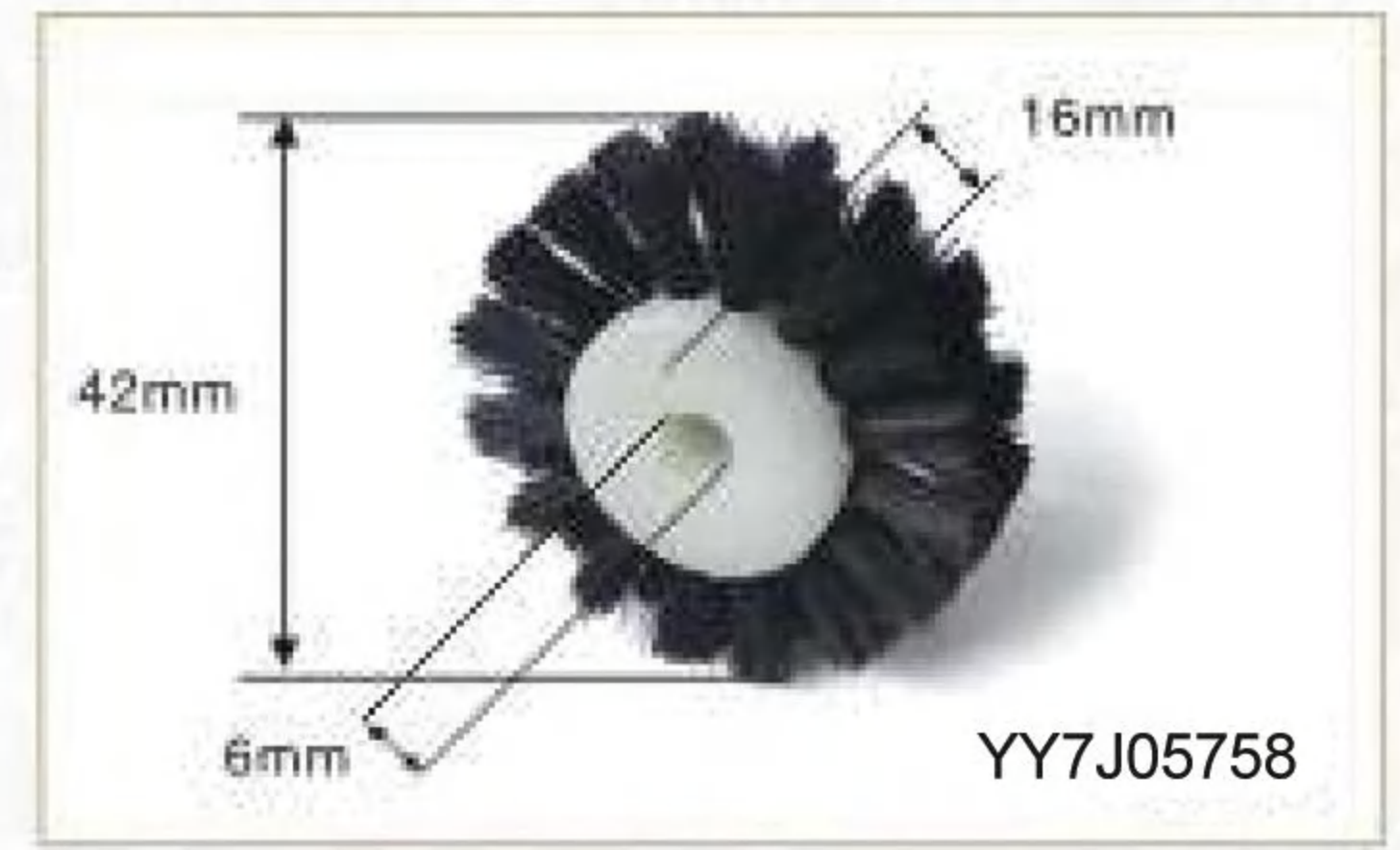
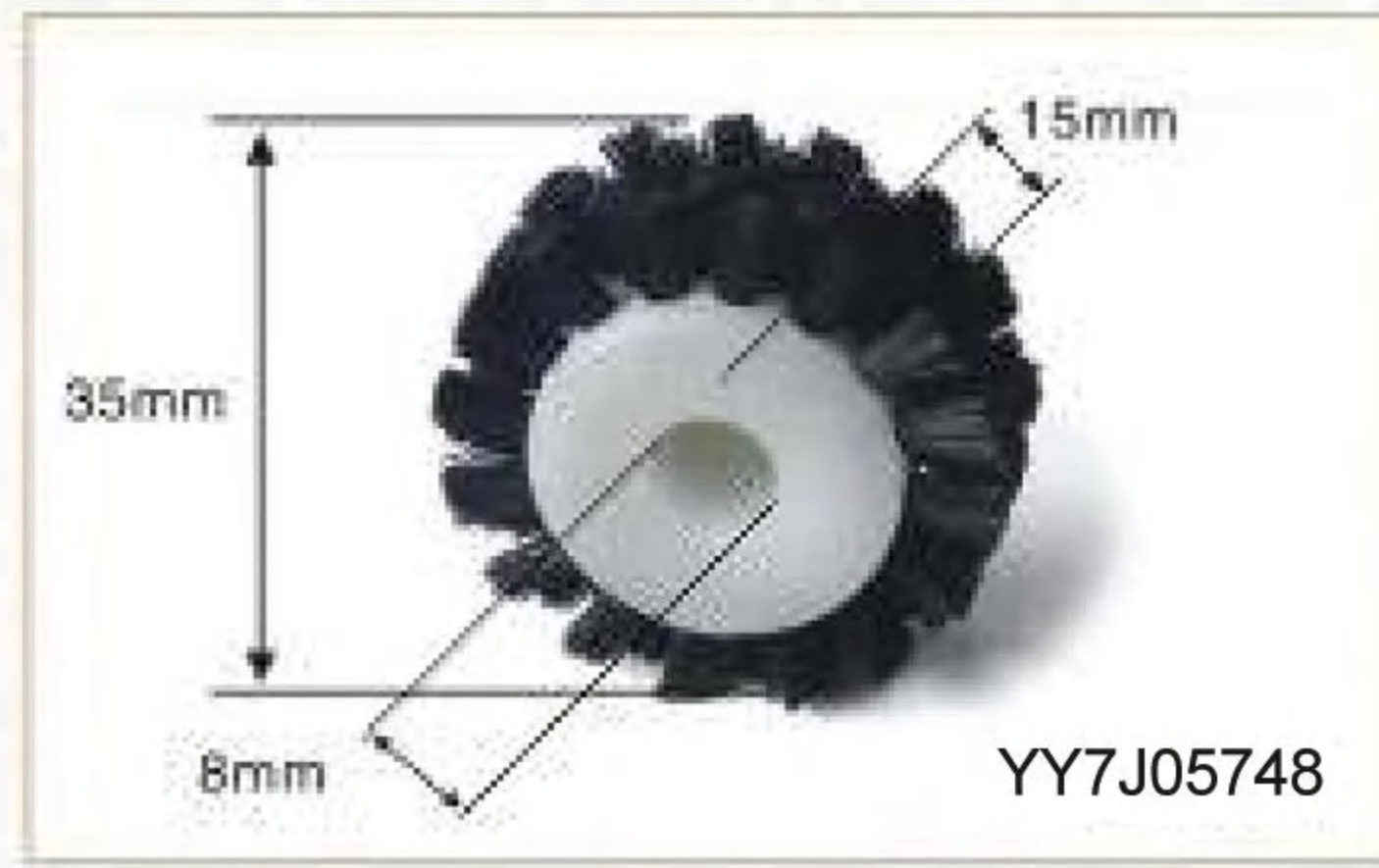
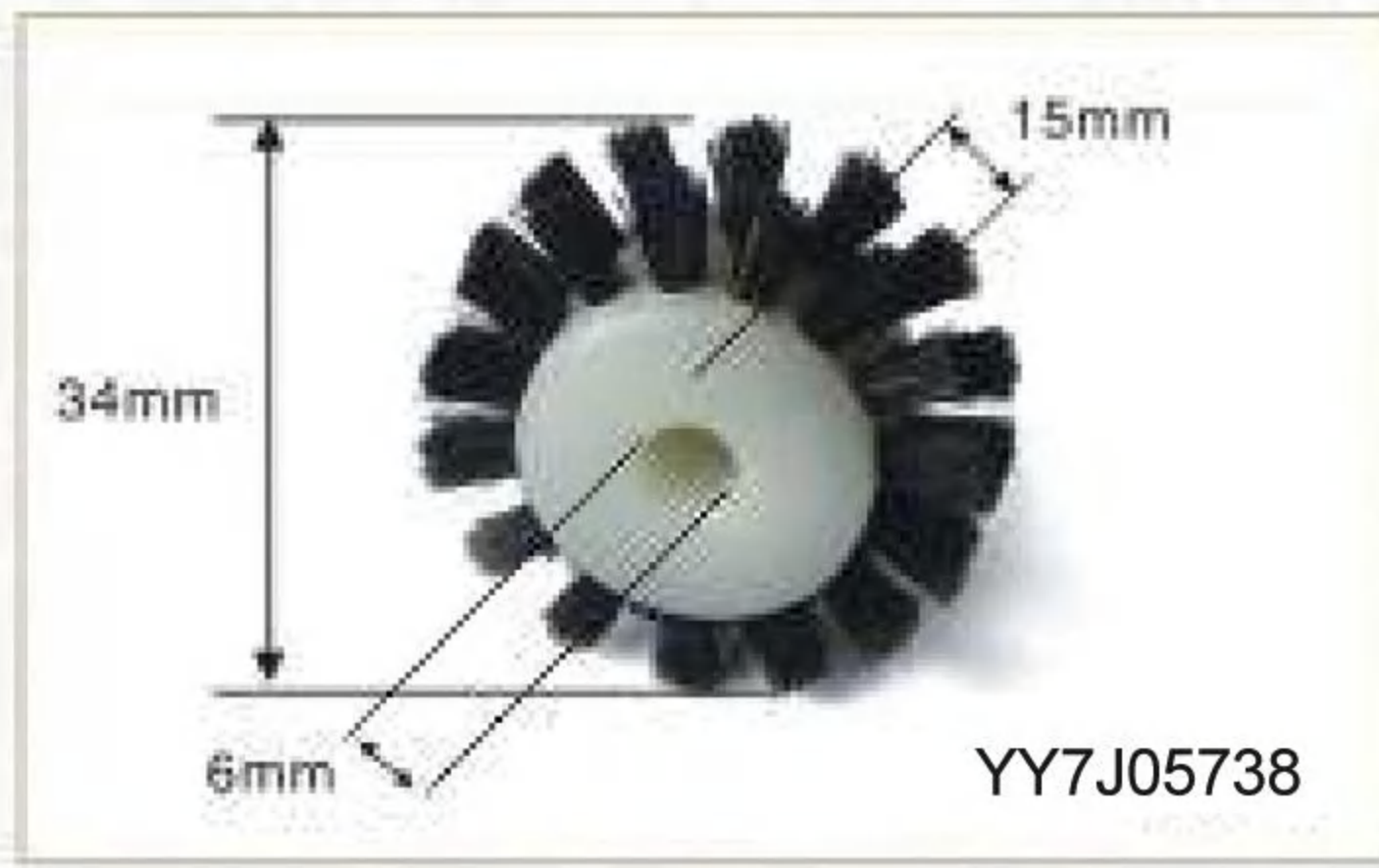

Feed Belt Feed Belt Feed Belt



Code	Belt Description
IMPORTED BELTS	
YY8J04081	0.8×25×30000mm
YY8J04091	0.8×28×30000mm
YY8J04101	1×20×30000mm
YY8J04111	1×25×30000mm
YY8J04121	1×28×30000mm
YY8J04131	1×30×30000mm
LOCAL BELTS	
YY8J04141	1x25x30000mm
YY8J04151	1x28×30000mm

Code	Belt Description
LOCAL BELTS	
YY8J04161	1×30×30000mm
YY8J04171	1.2×20×30000mm
YY8J04181	1.2×25×30000mm
YY8J04191	1.2×28×30000mm
YY8J04201	1.2×40×30000mm
YY8J04211	1.2×50×30000mm
YY8J04221	1.5×25×30000mm
YY8J04231	1.5×25×30000mm
YY8J04241	2×28×30000mm

G.T.O

1220×89mm

YY8J04258

S.M.102

220×38mm

YY8J04268

S.M.52

950×60mm

YY8J04278

S.M.74

1305×54mm

YY8J04288

M.O

1350×25mm

YY8J04298

S.M.74

YY8J04308

C.D.74

2420×138mm

YY8J04318

S.M.74

1420×86mm

J0432
YY8J04328

C.D.102

2890×210mm

YY8J04338

K8A

2587×160mm

YY8J04348

K8A

2587×160mm

YY8J04358

磨带机

YY8J04368

粘 合 机

YY8J04378

粘 合 机&胶 水

YY8J04398

粘 合 机&胶 水

YY8J04408
YY8J04418

S.O.R.K/S.O.R.M/S.O.R.D 1465×28mm  YY9J04428	S.M.102/72 2015×27mm  YY9J04438	S.O.R.K-Z/S.O.R.M-Z/S.O.R.D-Z 2015×28mm  YY9J04448	X.L.75/X.L.105 245×10mm  YY9J04458
R200 1440×50mm  YY9J04468	R300 1040×50mm  YY9J04478	R700 2880×80mm  YY9J04488	X.L.75/S.M.102 235×20mm  YY9J04498
RK3B/R600 1500×28mm  YY9J04508	FAVORIT-OB 1356×28mm  YY9J04518	Mitsurishi 3F/E 1980×25mm  YY9J04528	X.L.75/C.D.102 247×10mm  YY9J04538
Komar1 L28-428-528-628 2000×25mm  YY9J04548	Komar1 L40 2300×25mm  YY9J04558	Komar1 L26 1680×25mm  YY9J04568	S.M.74 229×20mm  YY9J04578
K8A Rapida 104/105 2600×28mm  YY9J04588	K8A Rapida 142/162 3160×28mm  YY9J04598	S.M.52 225×20mm  YY9J04608	S.M.74 229×20mm  YY9J04618
Komar1 210×14mm 52 Holes  YY8J04628	Komar1 210×14mm 26 Holes  YY9J04638	Komar1 210×14mm 35 Holes  YY9J04648	C.D.74 247×20mm  YY9J04658
S.M.52/C.D.74/X.L.105 225×20mm  YY9J04668	Mitsurishi 214×14mm  YY9J04678	S.M.102/C.D.102 215×38mm  YY9J04688	S.M.74 220×38mm  YY9J04698

Cinghie Belts

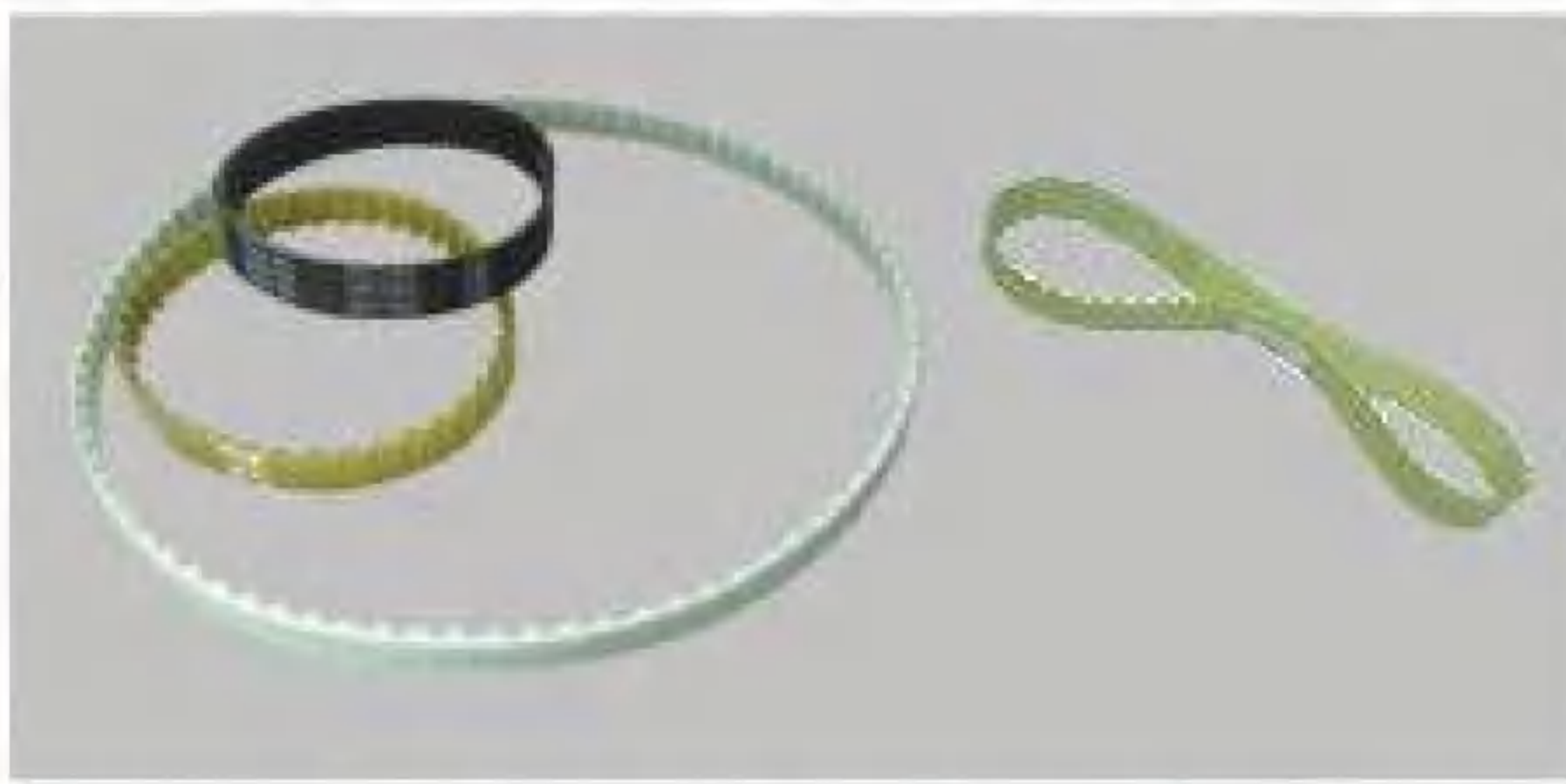

Code		Belt Description
YY10J04701	00.540.1445	4T2*90 CD74
YY10J04711	Polyurethane tape	T5-390-15
YY10J04721	Polyurethane tape	T5-690-16
YY10J04731	Polyurethane tape	T5-780-16
YY10J04741	Polyurethane tape	T5-990-25
YY10J04751	Polyurethane tape	T5-340-10
YY10J04761	Polyurethane tape	T5-280-8
YY10J04771	Polyurethane tape	T5-390-8
YY10J04781	Polyurethane tape	T5-280-8
YY10J04791	Polyurethane tape	T5-350-10
YY10J04801	Polyurethane tape	T5-280-8
YY10J04811	Polyurethane tape	T5-940-16
YY10J04821	Polyurethane tape	T5-215-10
YY10J04831	Polyurethane tape	T5-355-15
YY10J04841	00.540.1274	T5-340-17
YY10J04851	Polyurethane tape	T5-780-15
YY10J04861	Polyurethane tape	T5-690-16
YY10J04871	Polyurethane tape	T5-365-10
YY10J04881	Polyurethane tape	T5=200-8
YY10J04891	Polyurethane tape	T5-340-16
YY10J04901	Polyurethane tape	TS-200-8
YY10J04911	Polyurethane tape	T5-815-17
YY10J04921	Polyurethane tape	T5-1200-25
YY10J04931	Polyurethane tape	T5-440-10
YY10J04941	00.540.1526	T5-720-10
YY10J04951	Polyurethane tape	T10-840-16
YY10J04961	Polyurethane tape	T10-720-25
YY10J04971	Polyurethane tape	T10-1260-50
YY10J04981	Polyurethane tape	T10-840-14
YY10J04991	Polyurethane tape	T10-780-25
YY10J05001	Polyurethane tape	T10-840-15
YY10J05011	Polyurethane tape	T10-1260-60
YY10J05021	Polyurethane tape	T10-880-32
YY10J05031	Polyurethane tape	T10-2250-18
YY10J05041	Polyurethane tape	T10-1110-32
YY10J05051	Polyurethane tape	T10-840-32
YY10J05061	Polyurethane tape	T10-1080-45
YY10J05071	Polyurethane tape	T10-1150-20
YY10J05081	Polyurethane tape	T10-1110-50
YY10J05091	00.580.7328	3M312
YY10J05101	00.580.5192	3MR195-9
YY10J05111	MO 00.580.1529	32T10×880
YY10J05121	MO 00.580.1015	16T5×815
YY10J05131	MO 00.580.1226	8T5×280
YY10J05141	MO 00.580.1926	10T5×330
YY10J05151	SM 00.580.1029	8T5x330

Code			Belt Description
YY10J05161	GTO 46/52	00.270.0046	28×900
YY10J05171	GTO52		28×9×950
YY10J05181	GTO 46	00.270.0047	10PJ1168
YY10J05191	GTO46/52	00.270.0078	24PL1841
YY10J05201	GTO52	00.270.0072	16PJ1321
YY10J05211	GTO46/52	00.270.0071	47×1180
YY10J05221	GTO52VP	00.270.0057	24PJ1397
YY10J05231	GTOVP52	00.270.0098	24PJ1016
YY10J05241	GTO52	00.270.0088	24PJ2936
YY10J05251	GTO52	770J	20PJ1956Width50
YY10J05261	SM52	00.580.6695	16×350
YY10J05271	MOV/P	00.270.0086	15PL1715 MOV/P
YY10J05281	MO	00.580.1337	41×14*1300
YY10J05291	MO	00.270.0104	24PJ2083
YY10J05301	MOV	00.270.0089	24PJ-1244
YY10J05311	MOV/P	00.270.0104	24PJ-2083
YY10J05321	MO	575J 24PL 1445	Width56
YY10J05331	MOV/SM74	00.270.0108	15PL1613
YY10J05341	SM74-2C	00.270.0137	22PJ-1397
YY10J05351	SM744C	00.270.0133	19PL1841
YY10J05361	SM74-5C	00.270.0123	23PL1613
YY10J05371	SM74	00.270.0112	23PL1752
YY10J05381	SM74	24PL1650	Width105mm
YY10J05391	PM74	00.270.0147	13PL2324
YY10J05401	PM74	880L	14PL2235 Width66
YY10J05411	102V	00.270.0084	19PL2134
YY10J05421	102V	00.270.0100	19PL4470
YY10J05431	102Z	00.270.0052	20PL2362
YY10J05441	102F	00.270.0101	19PL2197
YY10J05451	102VP	00.270.0051	12PL4622
YY10J05461	102V		19PL 0097
YY10J05471	102V		12PL2743Width55
YY10J05481	CD102 NEW		25PL2200/W93
YY10J05491	SORK	00.270.0035	3327
YY10J05501	SORK	00.270.0036	3696
YY10J05511	GT Platen		L=2880mm
YY10J05521	T Platen	New Model	L=2380mm
YY10J05531	T Platen	Old Model	L=2290mm



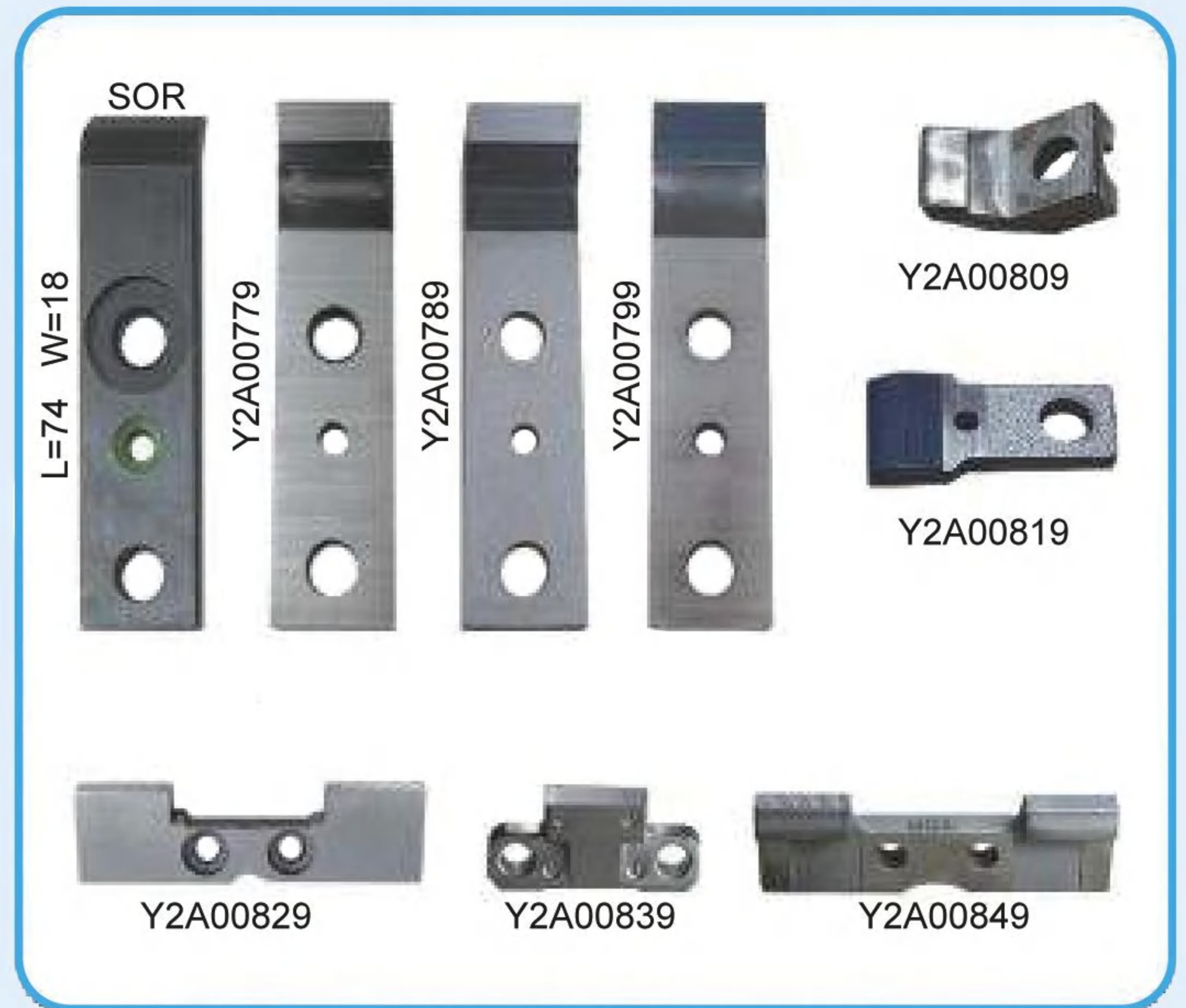

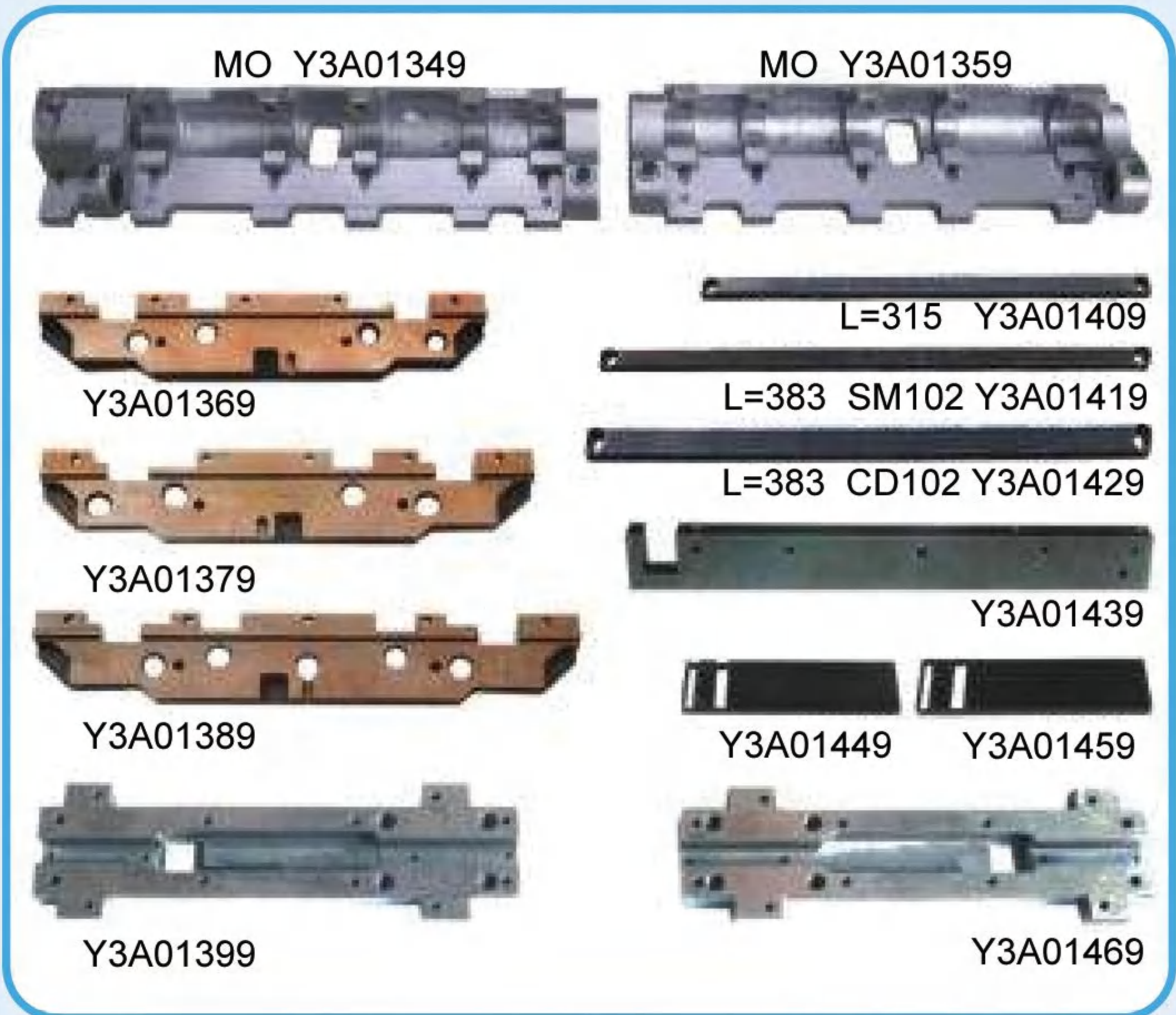
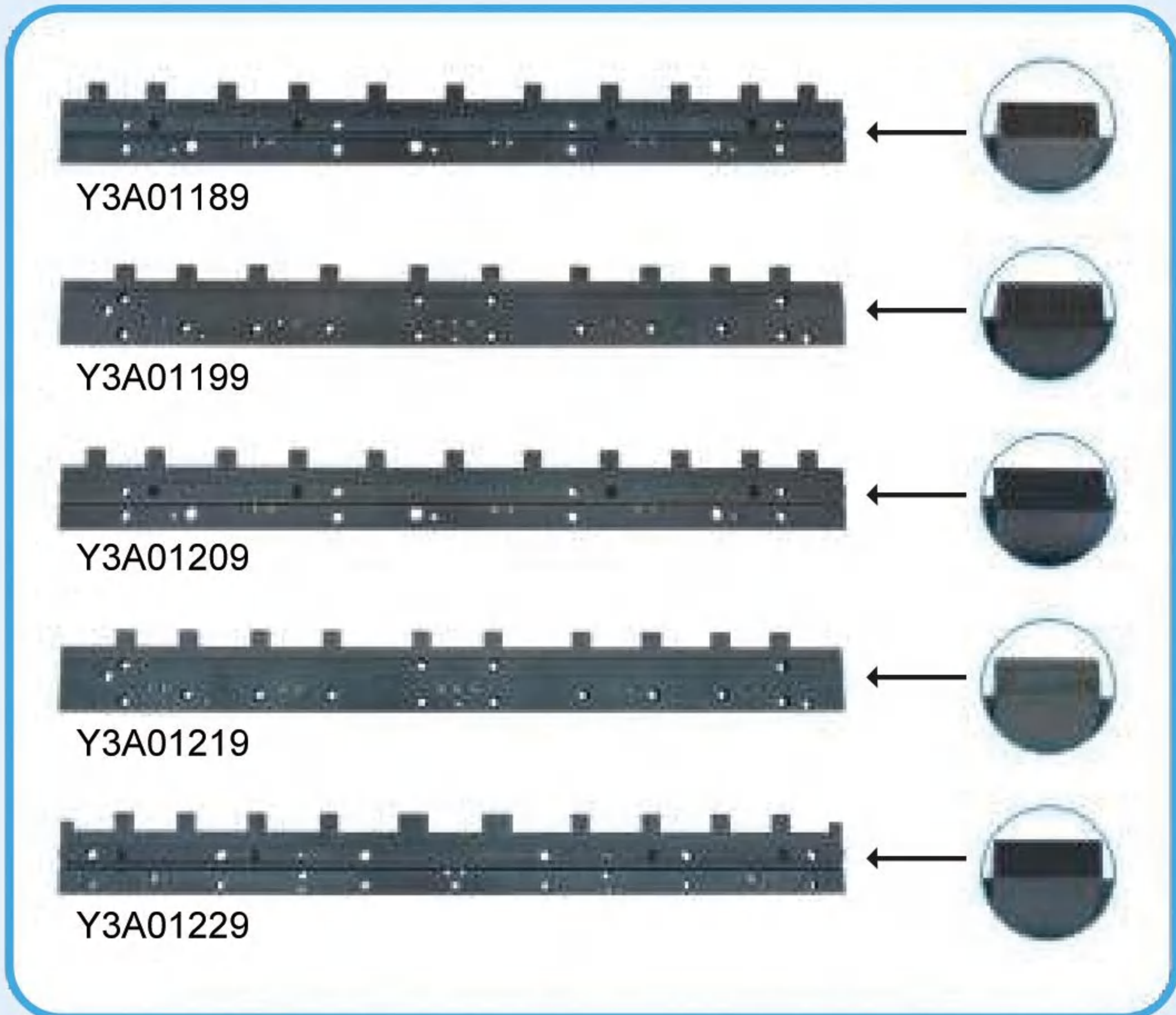
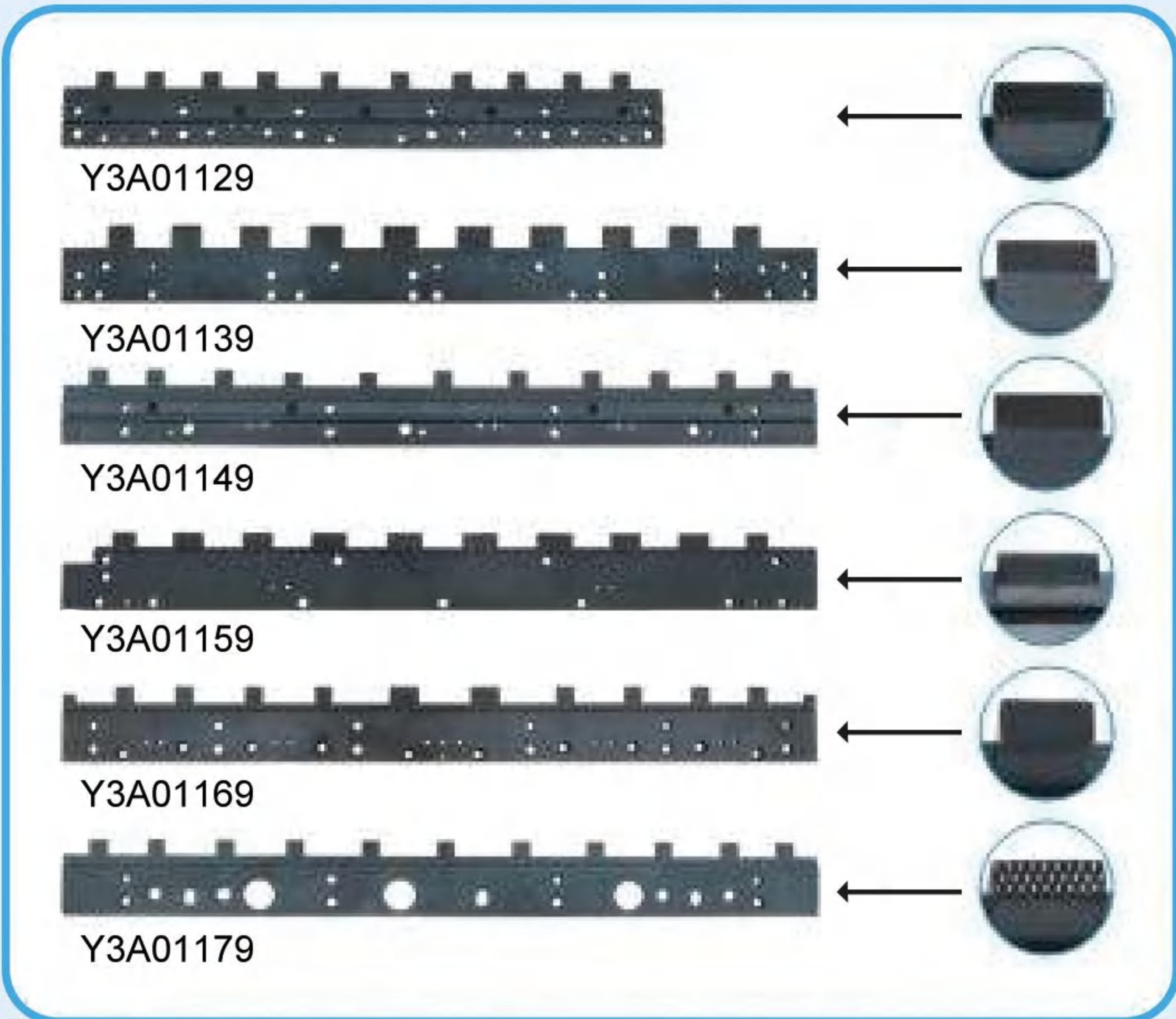
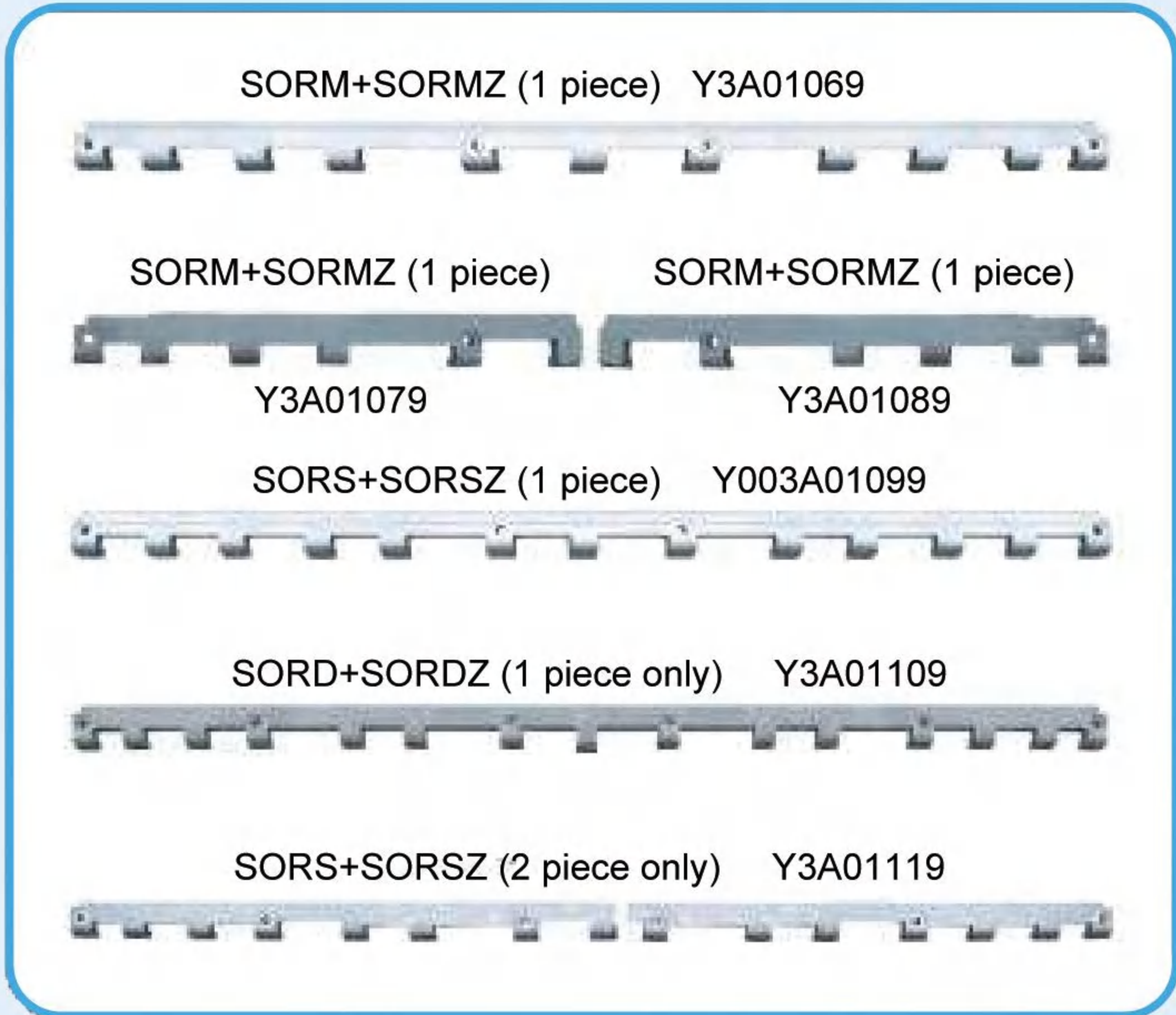
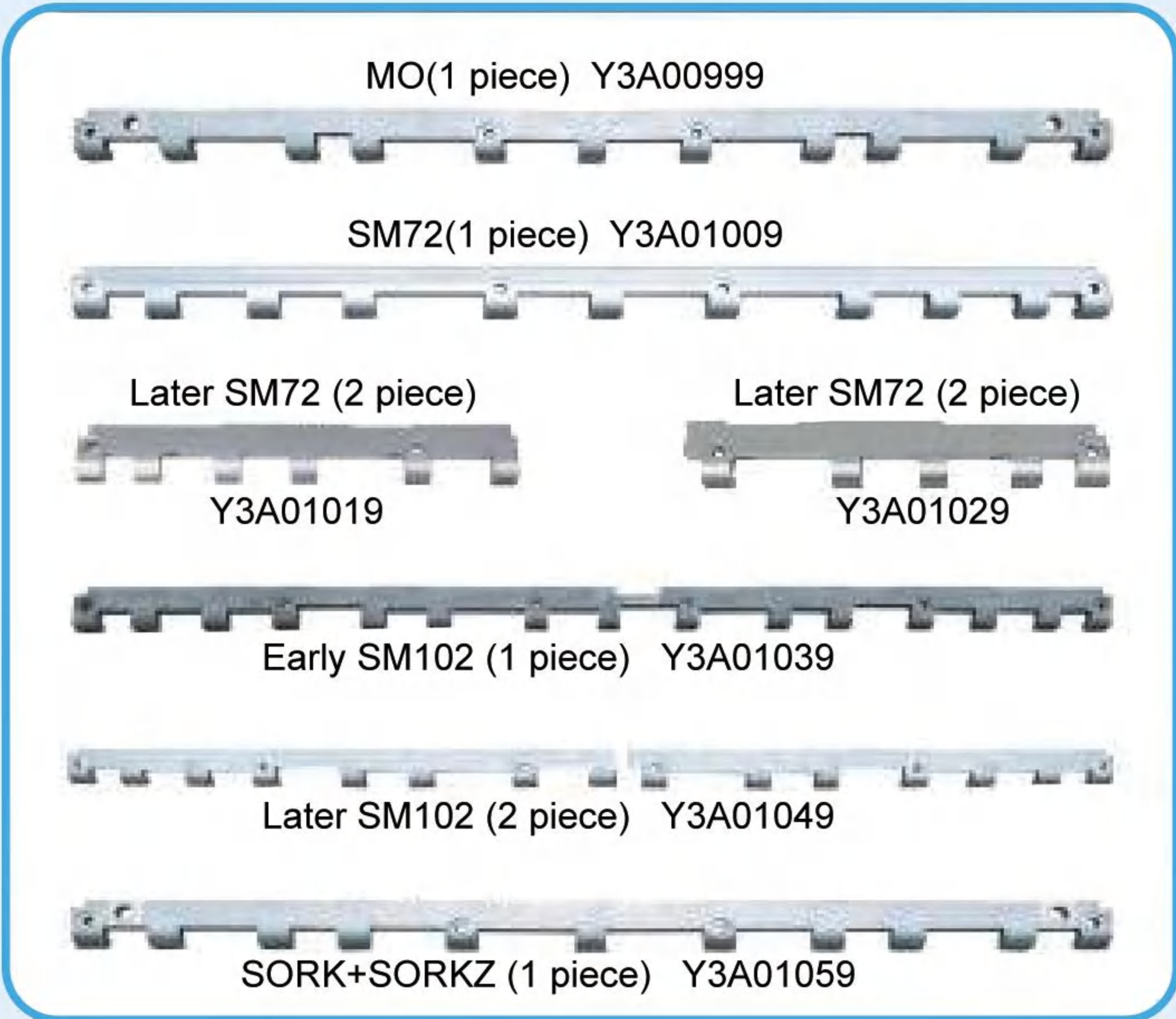



SM74 Y4A01479 Impression Cylinder Pad 13teeth



SM74 Y4A01489 Impression Cylinder Pad 13teeth



SM74 Y4A01499 Impression Cylinder Pad 13teeth



SM74 Y4A01509 Transfer Cylinder Pad 14teeth

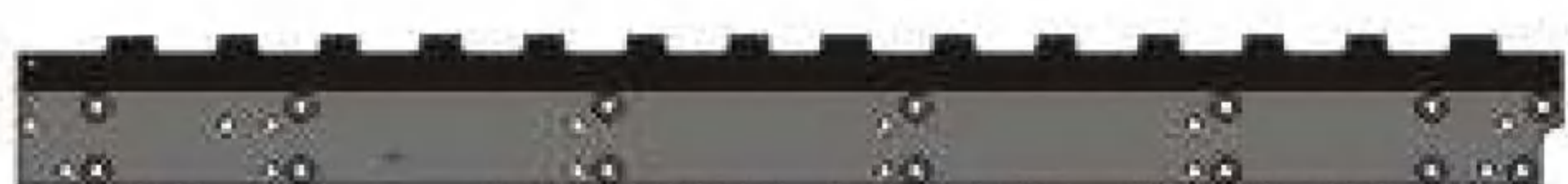

SM74 Y4A01519 Transfer Cylinder Pad 14teeth



SM52 Y4A01529 Impression Cylinder Pad 9teeth



SM52 Y4A01539 Transfer Cylinder Pad 10teeth



GTO Y4A01549 Transfer Cylinder Pad 11teeth



GTO Y4A01559 Impression Cylinder Pad 10teeth



GTO Y4A01569 Impression Cylinder Pad 10teeth



Y4A01579



Y4A01589



Y4A01599



Y4A01609



Y4A01619



GT Y4A01629



T Y4A01639



GTO46 Y4A01649



GTO52 Y4A01659

138*65mm



Y4A01669



COOD	OD
Y004A01679	730*160*45mm
Y004A01689	700*140*45mm
Y004A01699	780*100*45mm

COOD	OD
Y004A01709	750*480*45mm
Y004A01719	490*390*45mm
Y004A01729	475*395*45mm
Y004A01739	495*394*45mm
Y004A01749	595*290*45mm



Y4A01759



Y4A01769



Y4A01779



Y4A01789



GTO Y4A01799

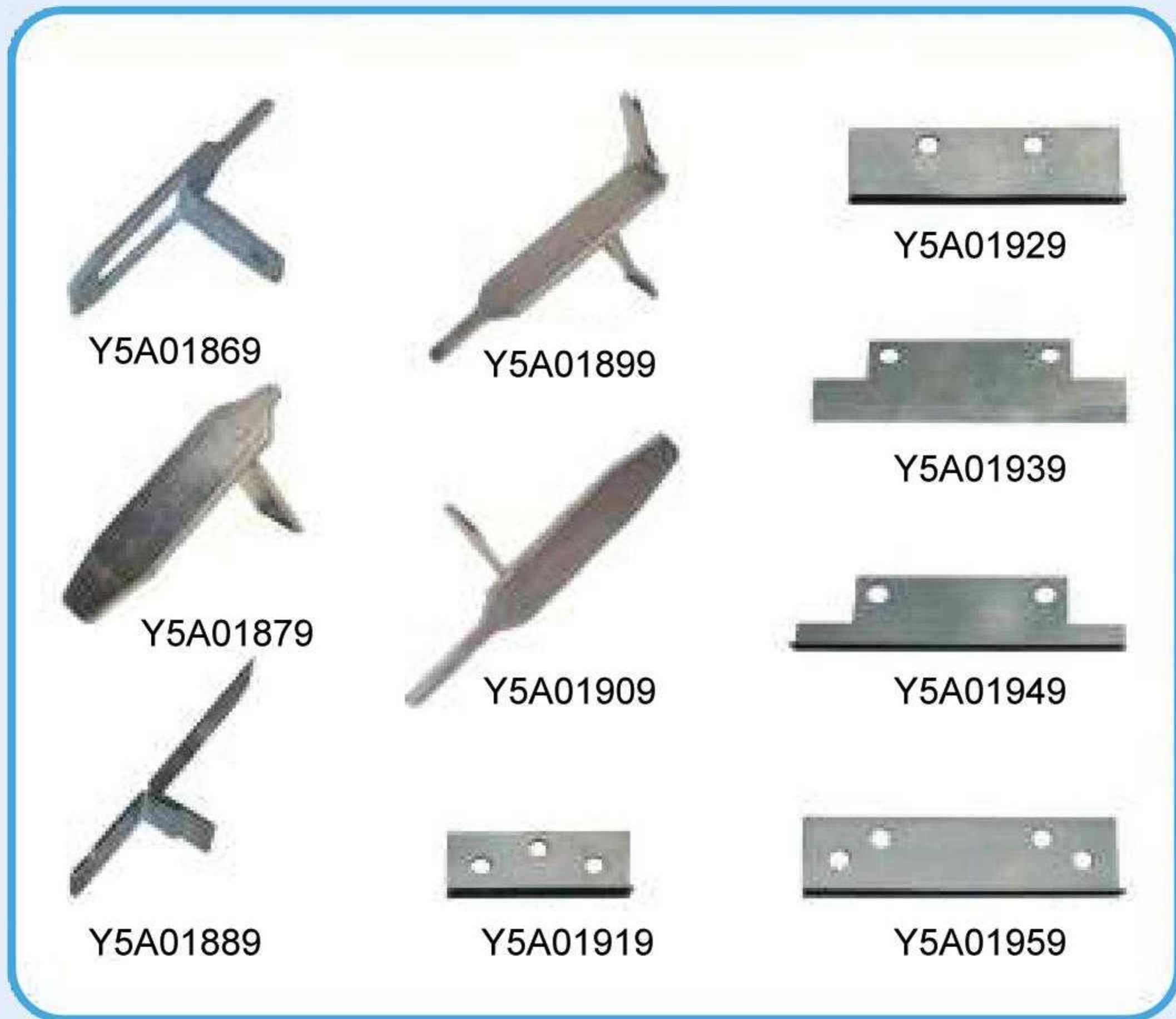

Y6A02349 Y6A02369

Y6A02339 Y6A02359

Y6A02379 Y6A02389 Y6A02399

①OD=60,ID=5,T=11 ①OD=53,ID=6,T=11 ①OD=46,ID=6,T=11
②OD=60,ID=5,T=11 ②OD=53,ID=6,T=11 ②OD=46,ID=6,T=11

Y6A02409 Y6A02419 Y6A02429

①OD=62,ID=5,T=11 ①OD=60,ID=6,T=11 ①OD=53,ID=6,T=11
②OD=65,ID=5,T=11 ②OD=60,ID=6,T=11 ②OD=53,ID=6,T=11

Y6A02439 Y6A02449 Y6A02499

Y6A02459 Y6A02469 Y6A02509

Y6A02479 Y6A02489 Y6A02519

Y6A02529 Y6A02559 Y6A02569

Y6A02539 Y6A02579

Y6A02549 Y6A02589

Y6A02599 Y6A02619 Y6A02649

Y6A02629 Y6A02659

Y6A02609 Y6A02639 Y6A02669

Y6A02679 Y6A02689 Y6A02699

Y6A02709 Y6A02719 Y6A02729

Y6A02739 Y6A02749 Y6A02759
OD=48,ID=8,T=9 OD=55,ID=8,T=20

Y6A02769 Y6A02779 Y006A02789 Y6A02799
OD=57,ID=12,T=20 OD=63,ID=8,T=20 OD=60,ID=8,T=20 OD=58,ID=9,T=15

SM74 Y6A02829

SM74 Y6A02819 SM74 Y6A02839
Y6A02809

SM74 Y6A02859 Y6A02869
Y6A02849

GTO Y6A02879 MO Y6A02889 Y6A02899

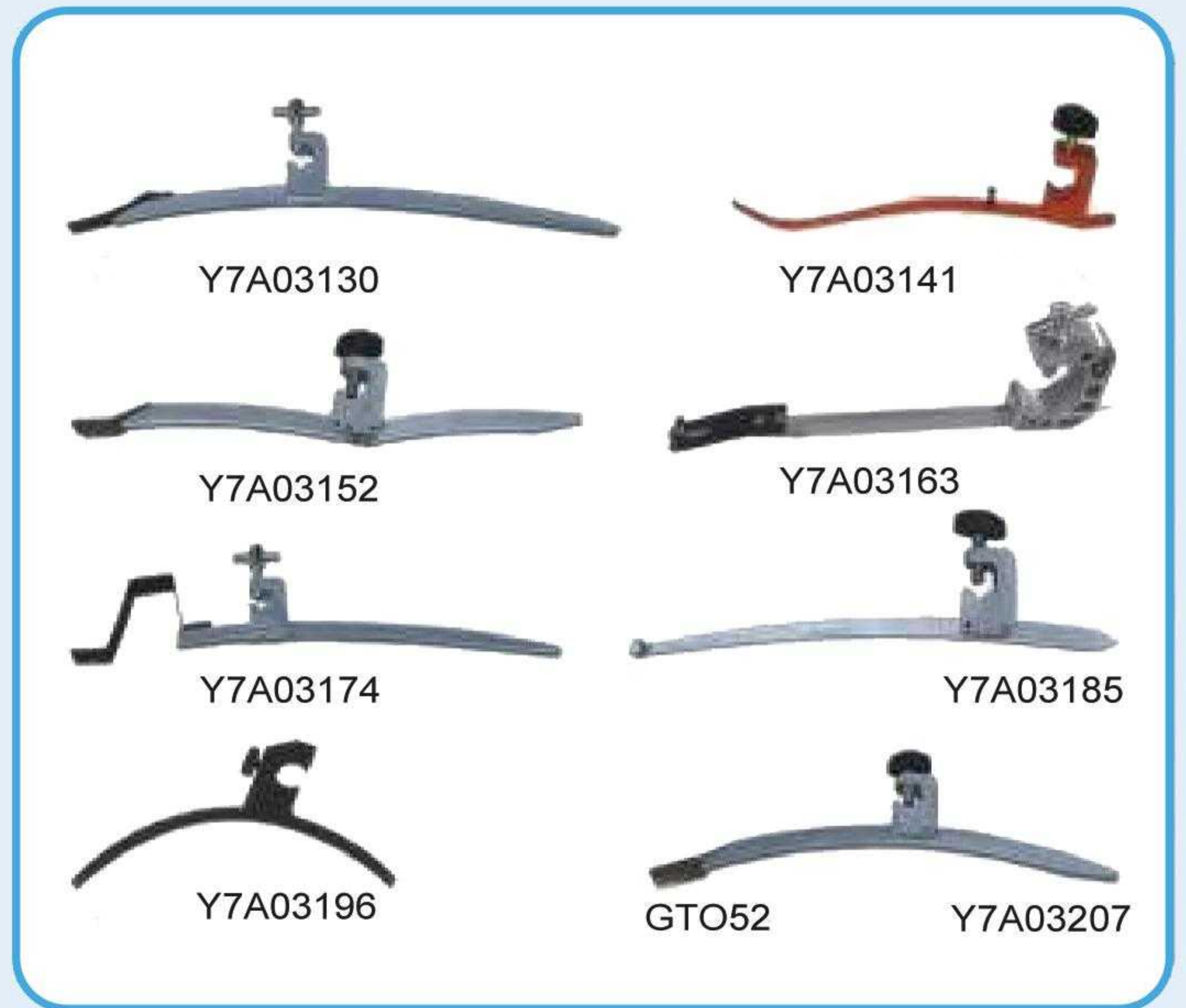
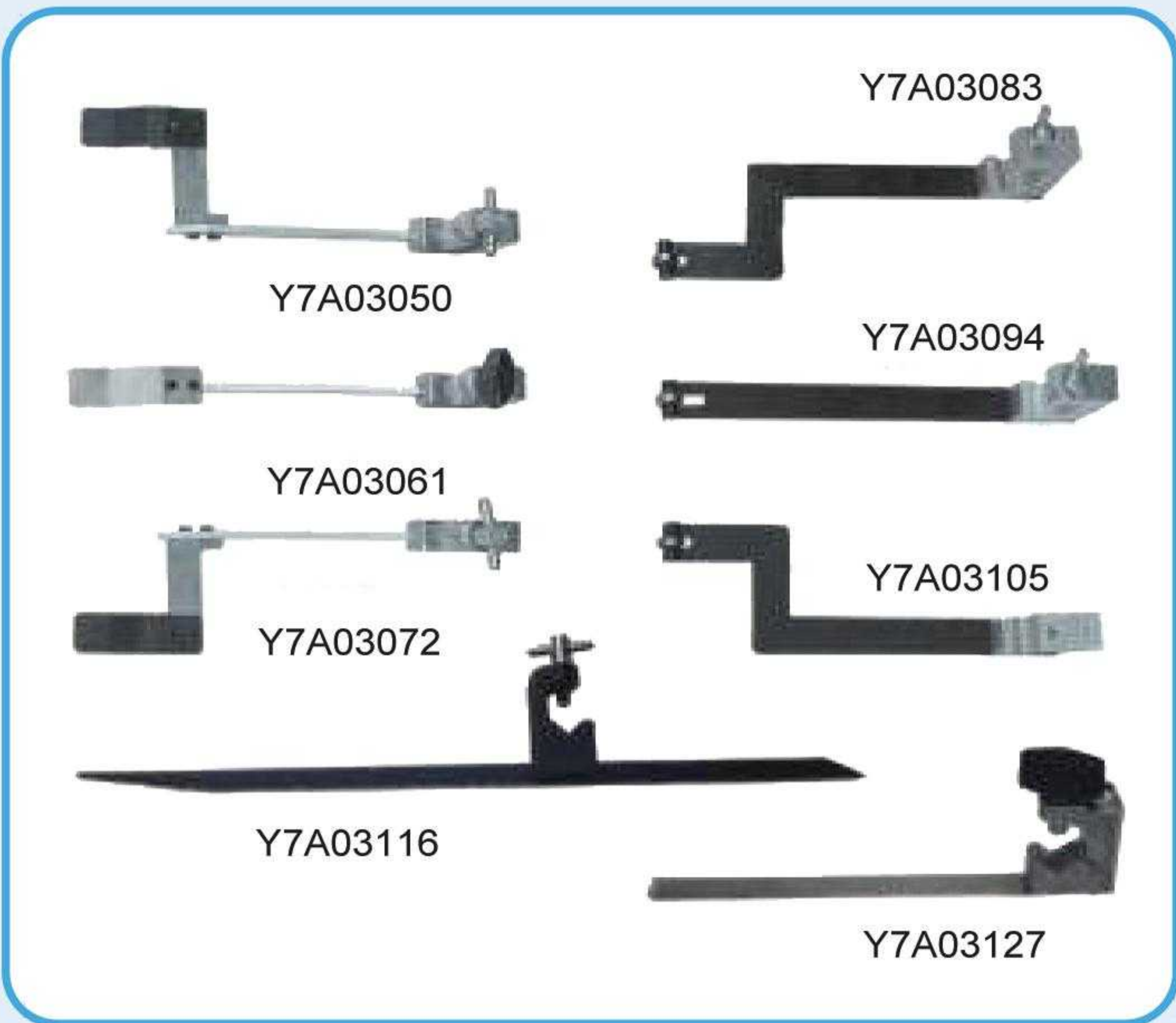
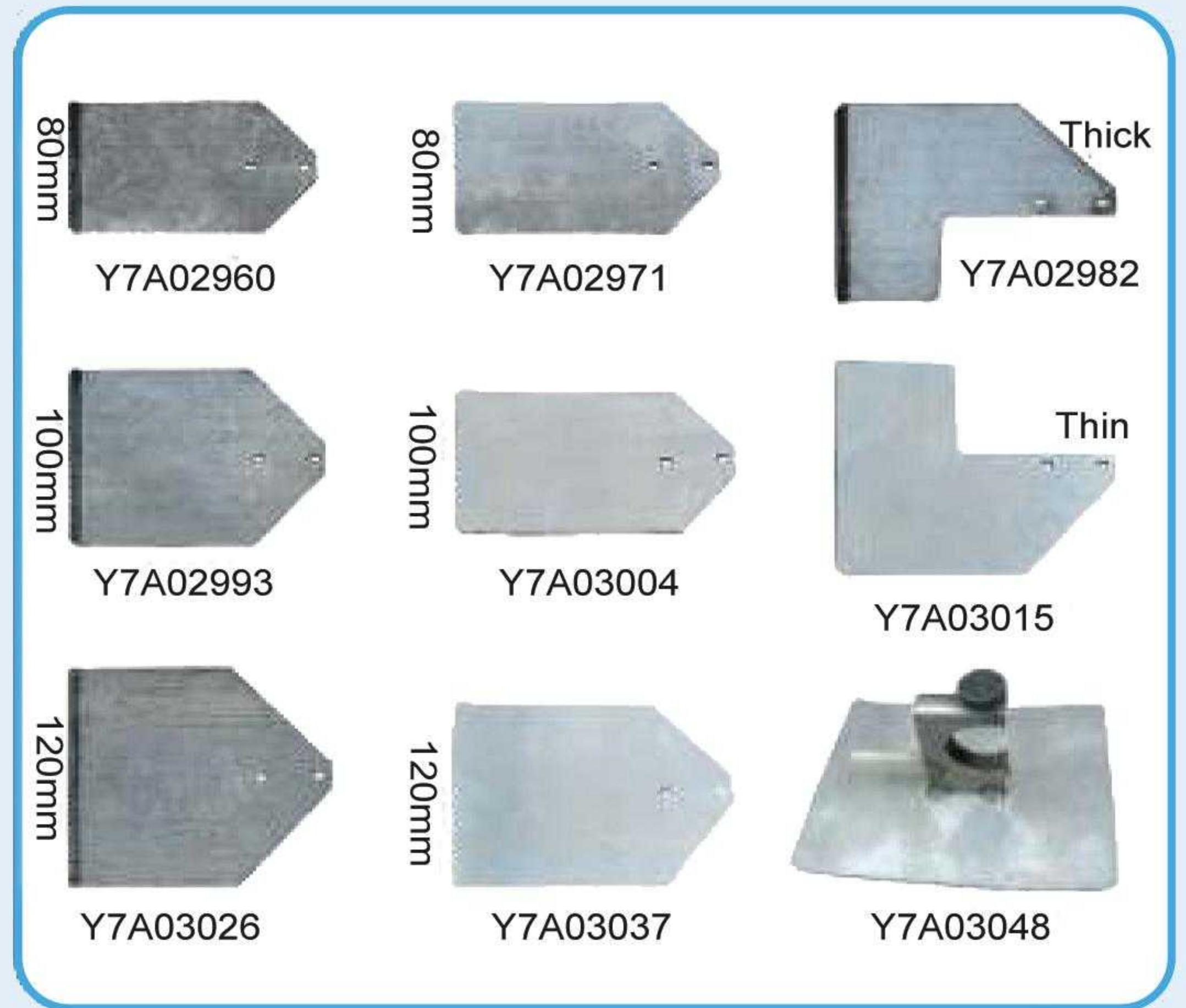
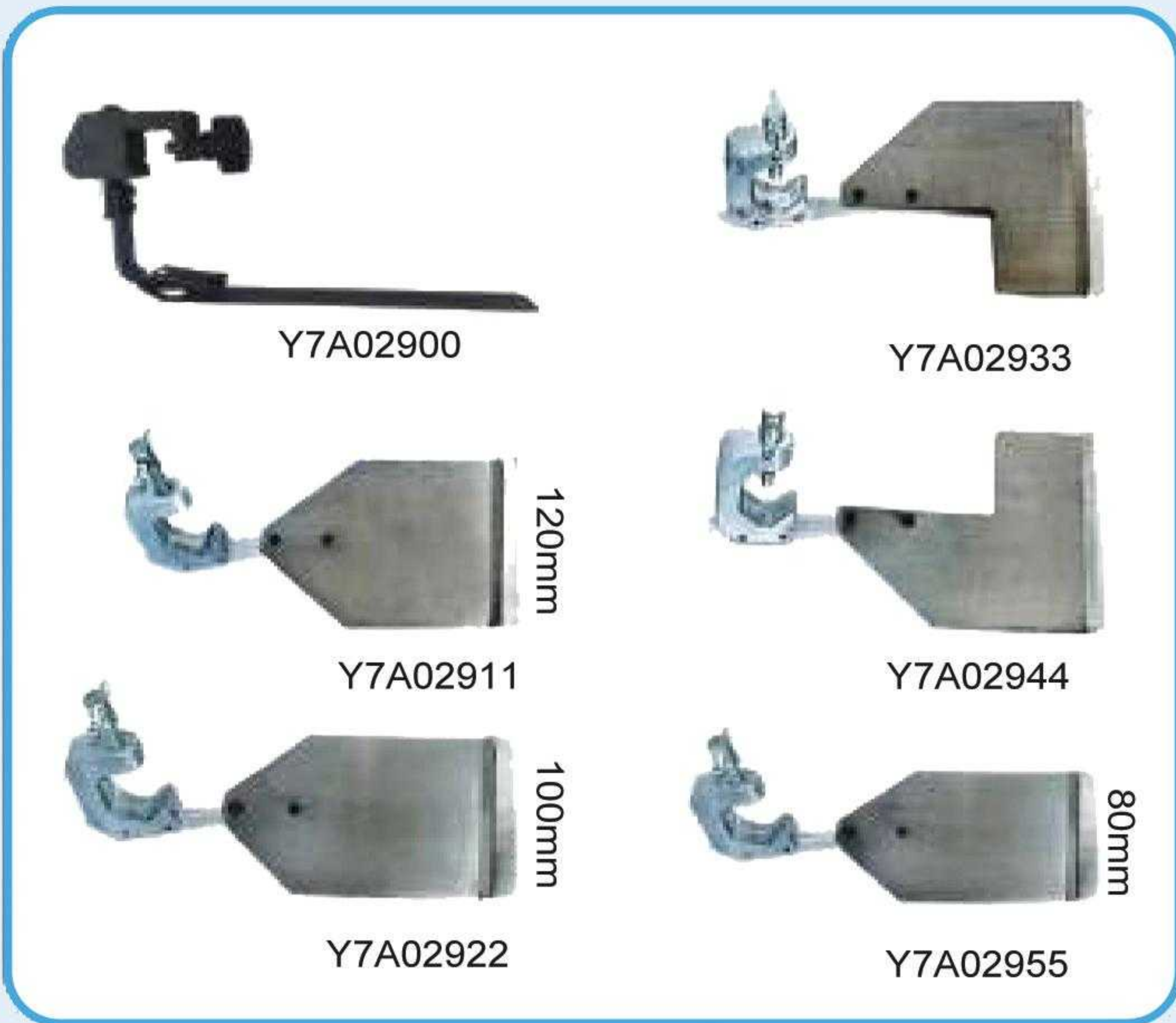





Y09A03972

Y09A03983 Y09A03992 Y09A04036

Y09A04000 L=100,D=9.5 SOFT Y09A04047 Y09A04058

Y09A04012 L=100,D=9.5 HARD

Y09A04024 L=200,D=21 Y09A04069



Y09A04071 Y09A04083 Y09A04095 Y09A04107

Y09A04115 Y09A04126 Y09A04136 Y09A04147

Y09A04159 Y09A04160 Y09A04172

Y09A04189 Y09A04192

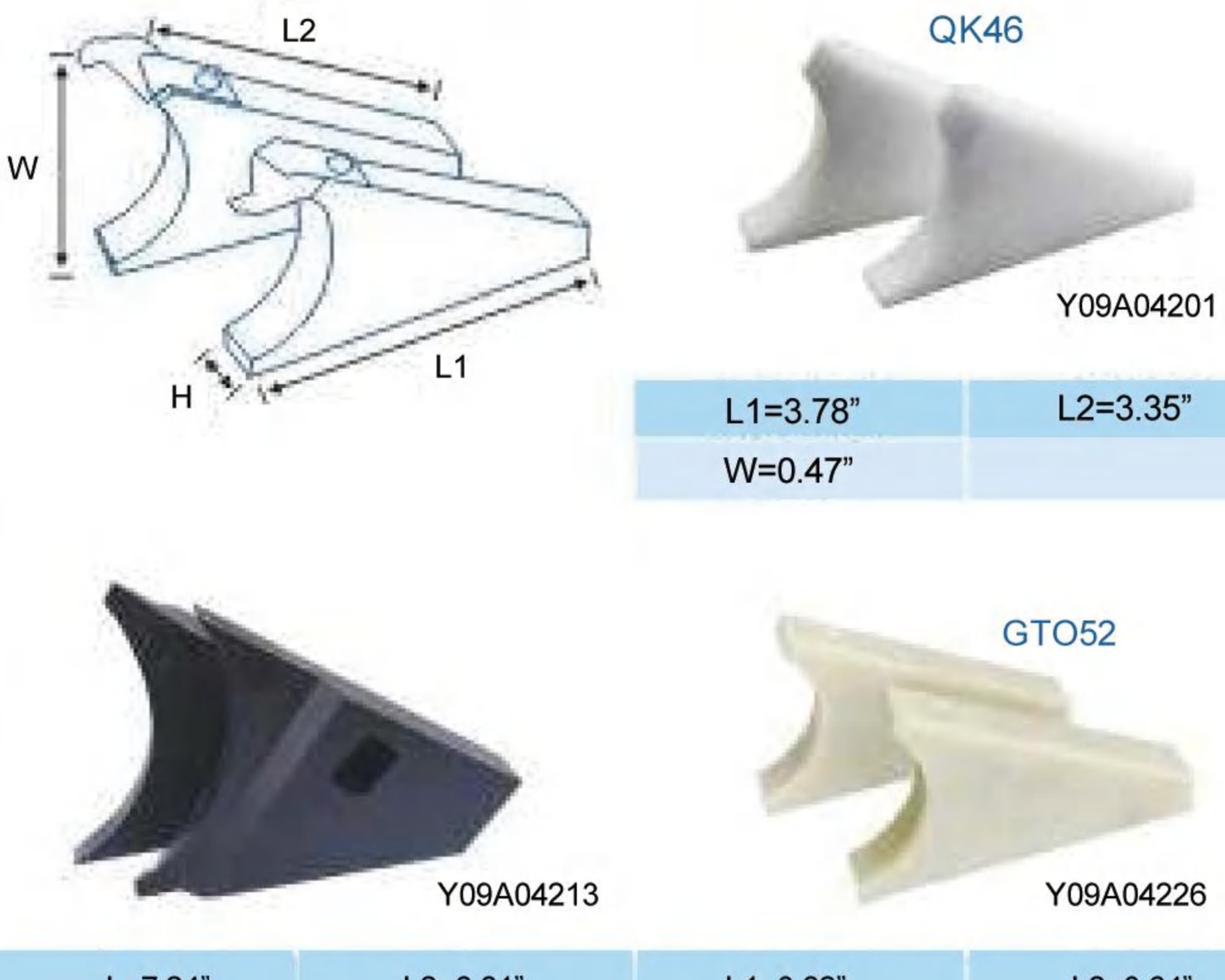

QK46 Y09A04201

L1=3.78"	L2=3.35"
W=0.47"	

Y09A04213 Y09A04226

L=7.24"	L2=6.61"	L1=3.82"	L2=3.64"
W=6.02"		W=0.55"	



GTO52 GTO CON

Y09A04231 Y09A04242

L1=3.82"	L2=3.54"	L1=4.17"	L2=4.33"
W=0.55"	H=2.24"	W=0.55"	H=1.93"

SM 52 CON MO

Y09A04252 Y09A04261

L1=4.21"	L2=4.29"	L1=5.12"	L2=5.12"
W=0.55"		W=0.55"	H=2.24"



SM74 SM 74 CD

Y09A04271 Y09A04282

L1=5.75"	L2=5.75"	L1=5.83"	L1=5.85"
W=0.52"	H=2.52"	W=0.52"	

SM102 and SM72 WEB 8/12/16

Y09A04294 Y09A04300

L1=6.38"	L2=6.38"	L1=3.07"	L2=3.25"
W=0.52"	H=3.07"	W=0.52"	



44MM 35MM

Y09A04312 Y09A04324 Y09A04333 Y09A04340 Y09A04357 Y09A04367

Y09A04379 Y09A04380 Y09A04390 Y09A04401

Y09A04413 Y09A04424 Y09A04435 Y09A04446 Y09A04459 Y09A04460















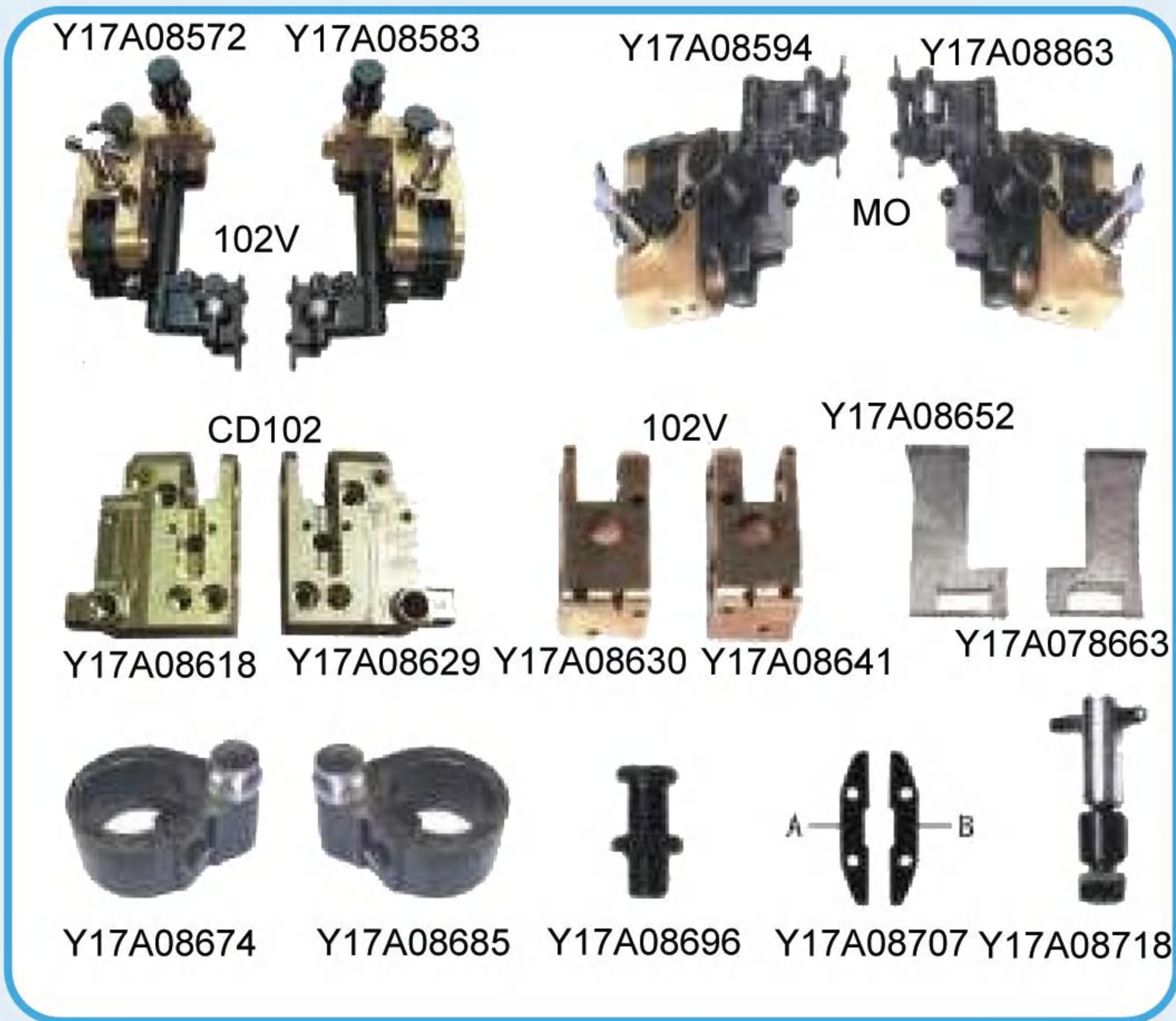



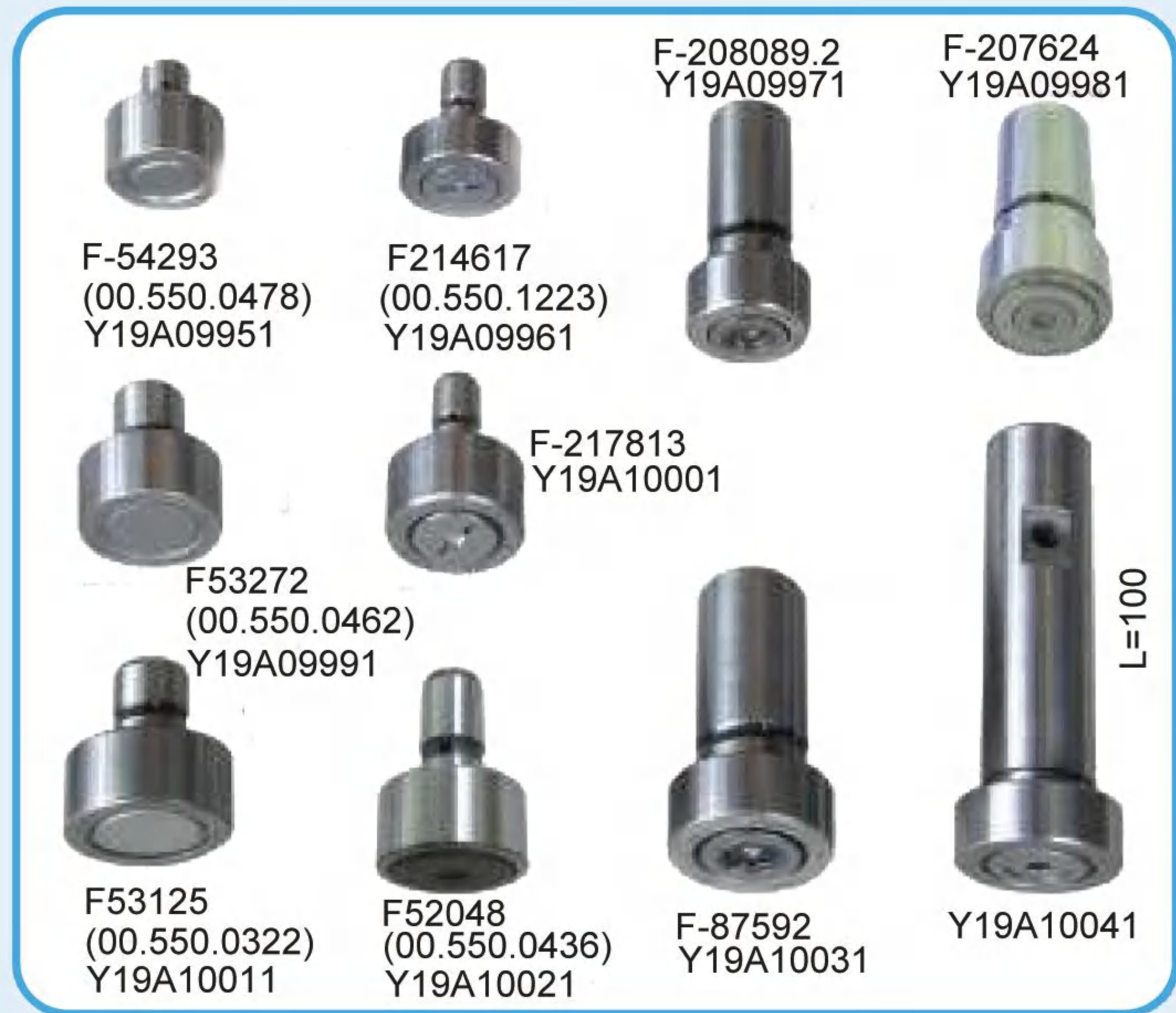

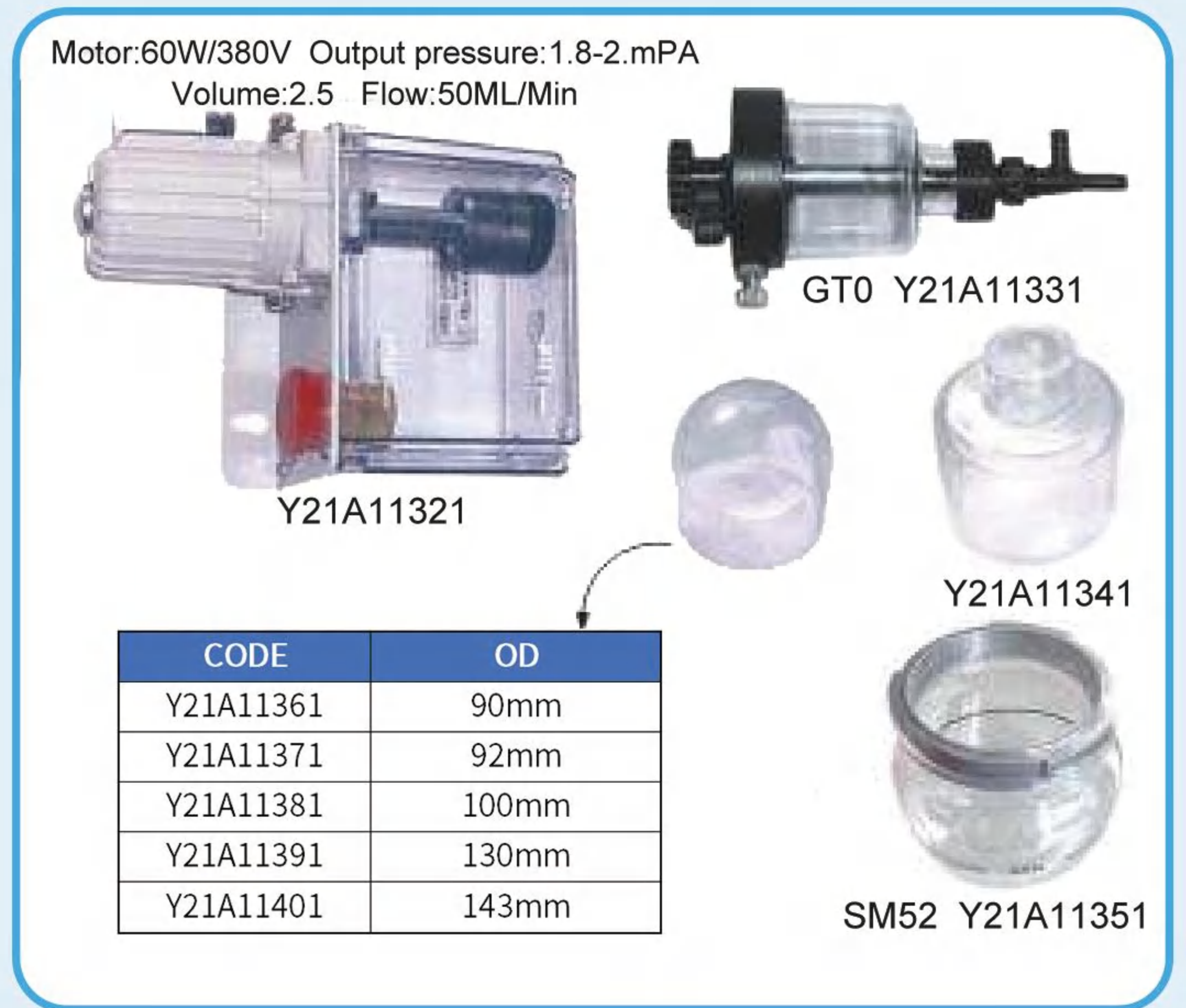

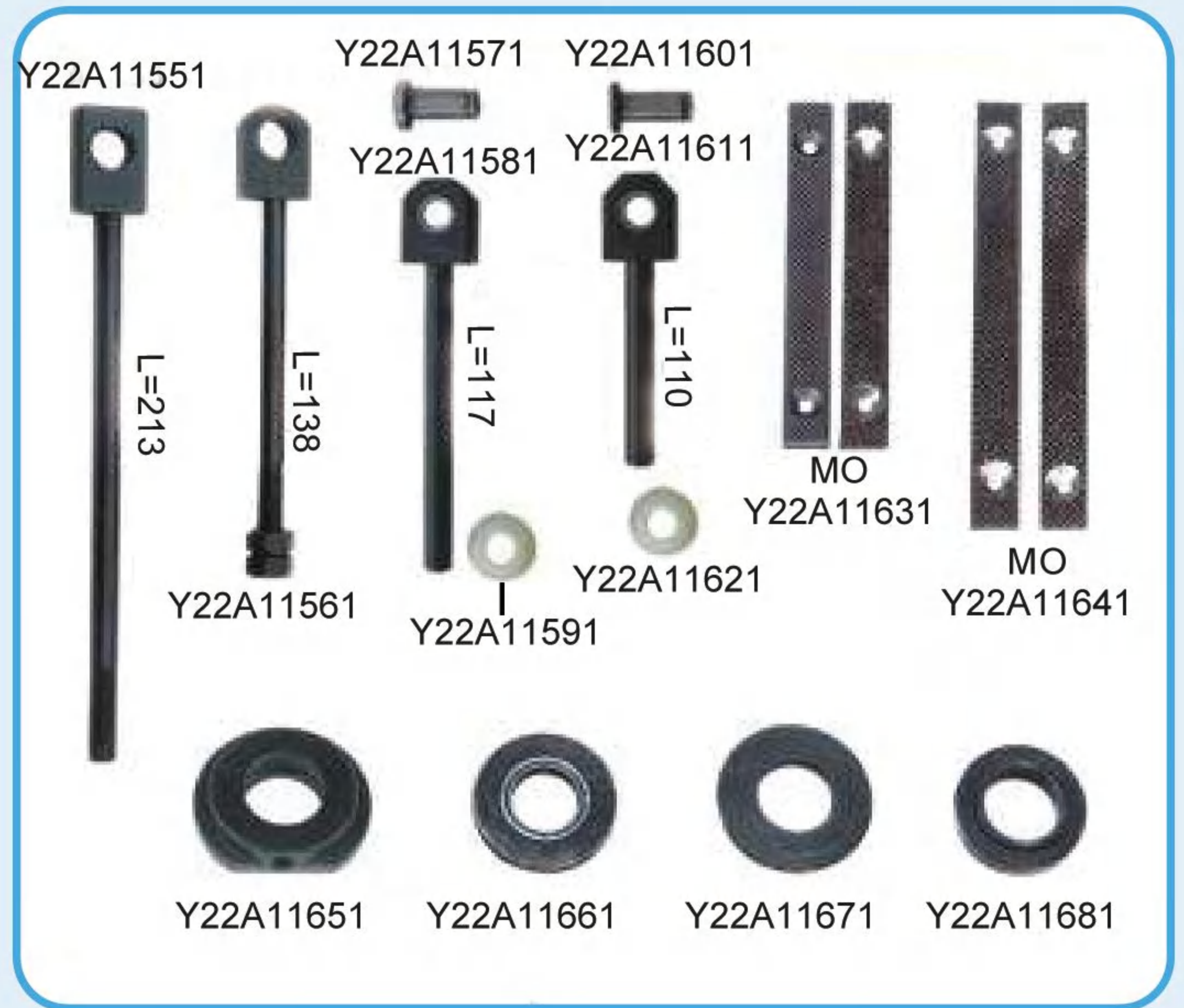







O Ring

CODE	PARTS NO.	MODEL	OD
Y25A13701	00.580.1069	FOR GTO/MO	R44mm
Y25A13711	00.580.5481	FOR PM/SM52	R90mm
Y25A13721	00.580.4270	FOR PM/SM52	R60mm
Y25A13731	00.580.5559	FOR SM/CD74,XL105	R87mm
Y25A13741	00.580.1134	FOR SM/PM74,CD102	R6.3mm
Y25A13751	00.580.6861	FOR CD74	R9mm
Y25A13761	00.580.1617	FOR SM72/102	R80mm
Y25A13771	00.580.6404	FOR SM/CD102,XL105	R19mm
Y25A13781	00.580.3929	FOR SM/CD74,XL105	R22mm
Y25A13791	00.580.4731	FOR XL105	R27mm
Y25A13801	00.580.6409	FOR XL105	R30.2mm

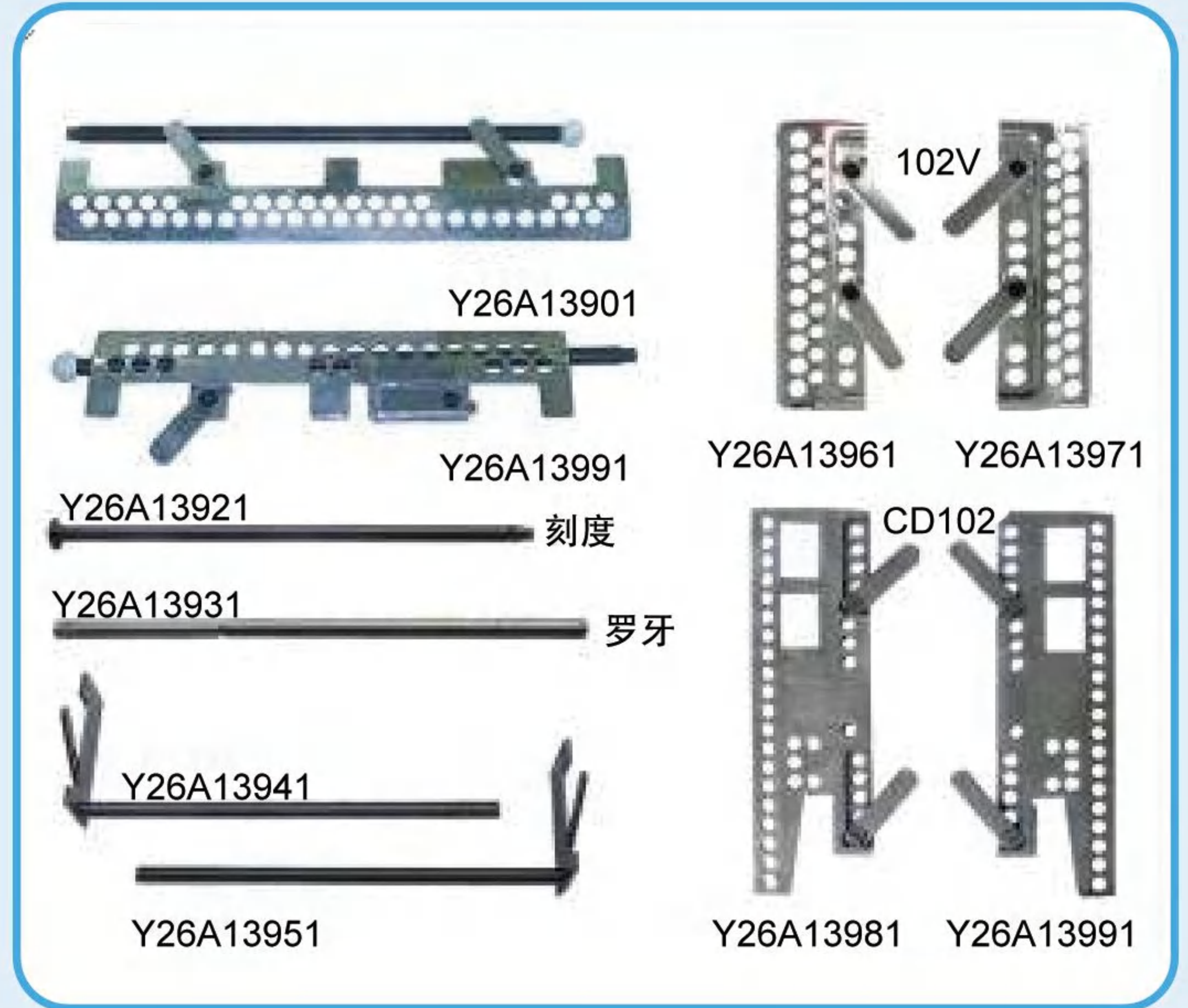



Y27A14311



Y27A14321



Y27A14331



Y27A14341



Y27A14351



Y27A14361



Y27A14371



Y27A14381



Y27A14391



Y27A14401



Y27A14411



Y27A14421



Y27A14431



Y27A14441



Y27A14451



Y27A14461



Y27A14471



Y27A14481



Y27A14491



Y27A14501



Y27A14511



Y27A14521



61.110.1495

Y27A14531



F2.112.134/04
Y27A14541



Y27A14551



Y27A14561



Y27A14571



Y27A14581





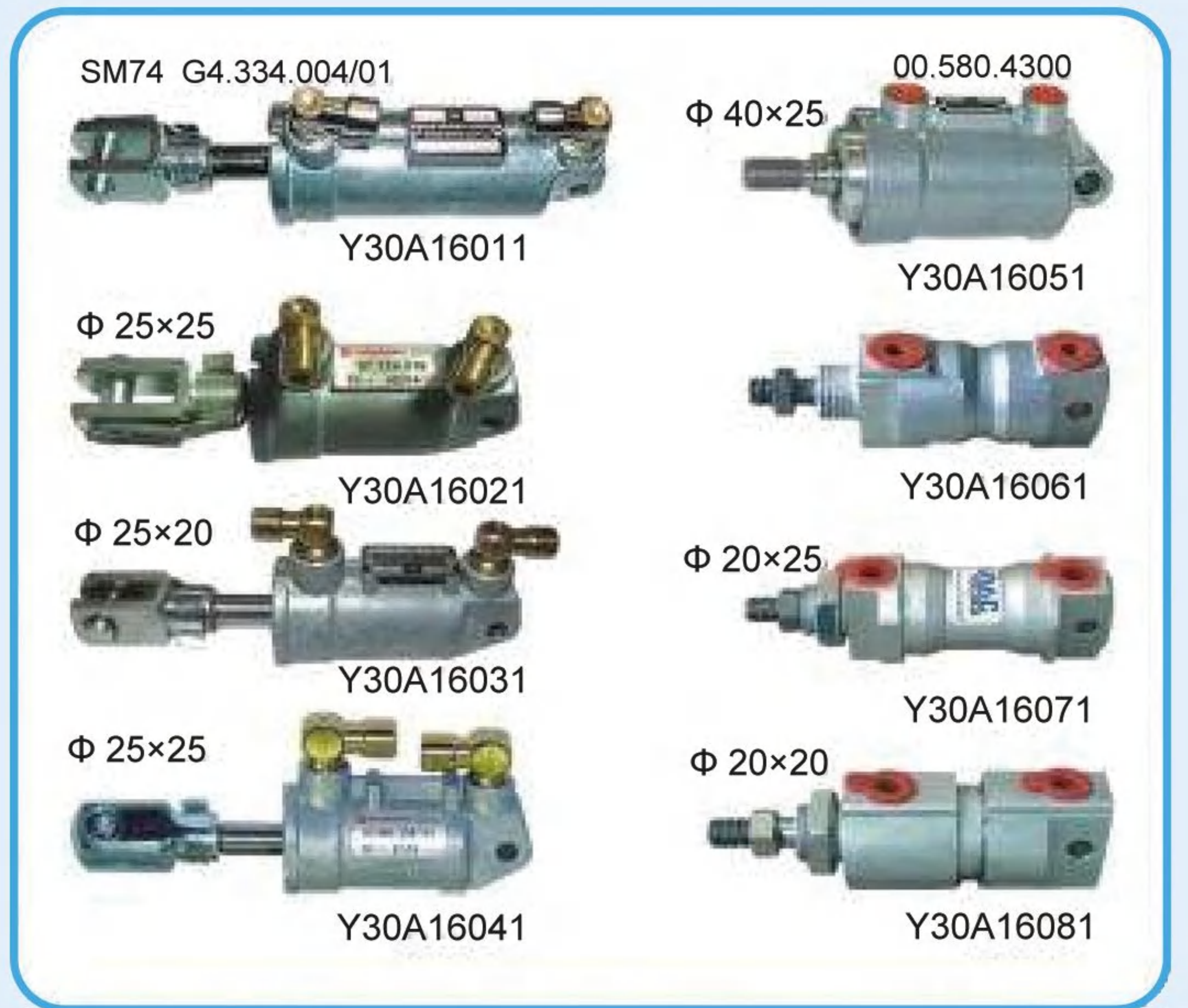



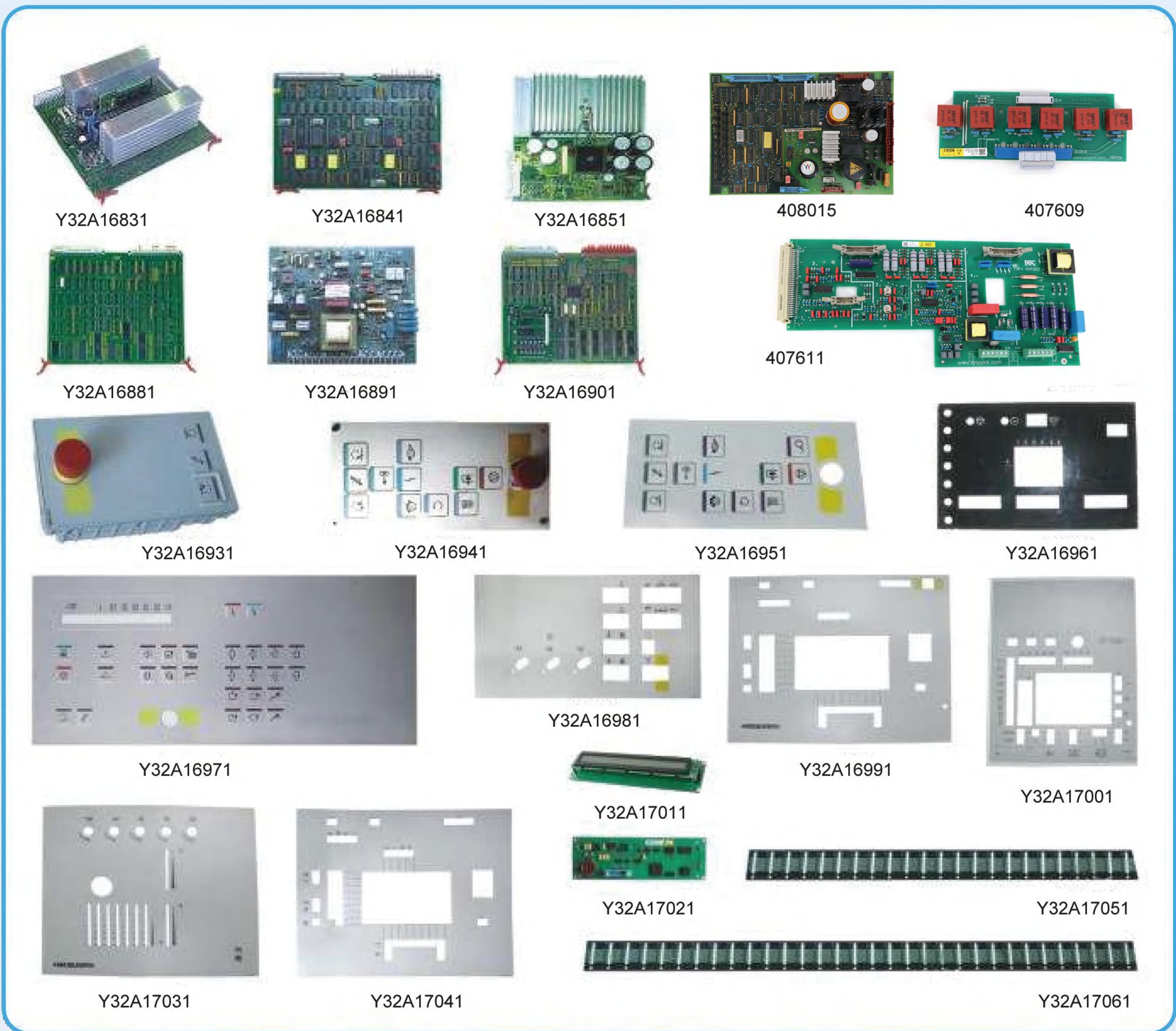

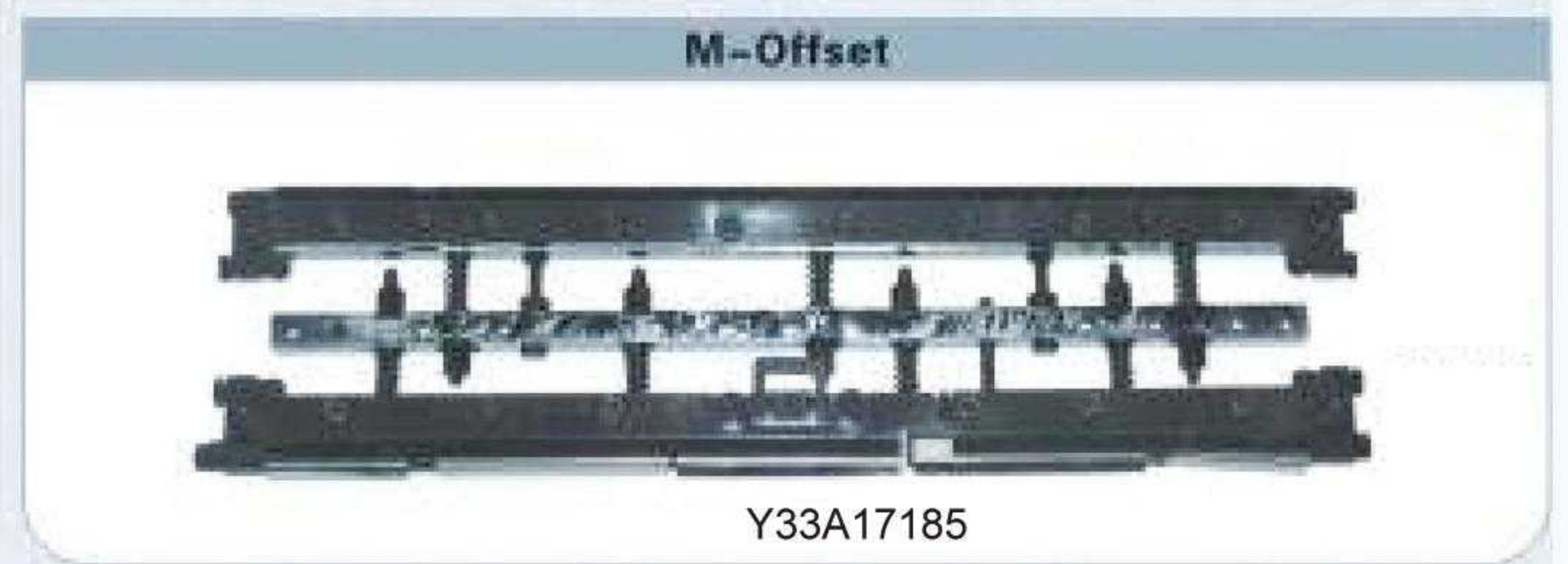

KORD Y34A17275
 TOK Y34A17285
 MO Y34A17295
 T L=353 Y34A17305
 GTO Y34A17315
 GT L=440 Y34A17325
 Y34A17335 GTO52
 Y34A17345GTO46
 Y34A17355 MO
 Y34A17275 MO
 Y34A17375 KOR
 KORD 64 Y34A17385
 KORS Y34A17395
 MO Y34A17405
 SBB L=850 Y34A17415
 SBD L=945 Y34A17425
 SGS L=1020 Y34A17435

AUTO PLATE CLAMPS

CODE	PARTSNO.	MODEL
Y34A17444	00.580.4473/03	SM52
Y34A17455	00.580.4128/03	SM74/CD74/PM74
Y34A17466	00.580.4129/03	SM102/CD102
Y34A17477	F4 334.039	XL105

CLAMPS AIR TUBE

CODE	Y34A17522	Y34A17533	Y34A17544	Y34A17555
MODEL	SM52	SM74	SM102	XL105

Y34A17295
 Y34A17295
 Y34A17295
 Y34A17295
 CD102 Y34A17565
 SM52 Y34A17575
 SM74 Y34A17585
 SM72/SORM Y34A17595
 SORD Y34A17605

SM52 Y34A17615
 SM74 Y34A17625
 SM102 14 GRIPPERS Y34A17635
 SM102 18 GRIPPERS Y34A17645
 SM52
 Y34A17655 Y34A17665
 SOR Y34A17675
 Y34A17685
 Y34A17695
 CD102
 Y34A17645 Y34A17645
 Y34A17645 SOR
 Y34A17725
 Y34A17765 102
 A1776

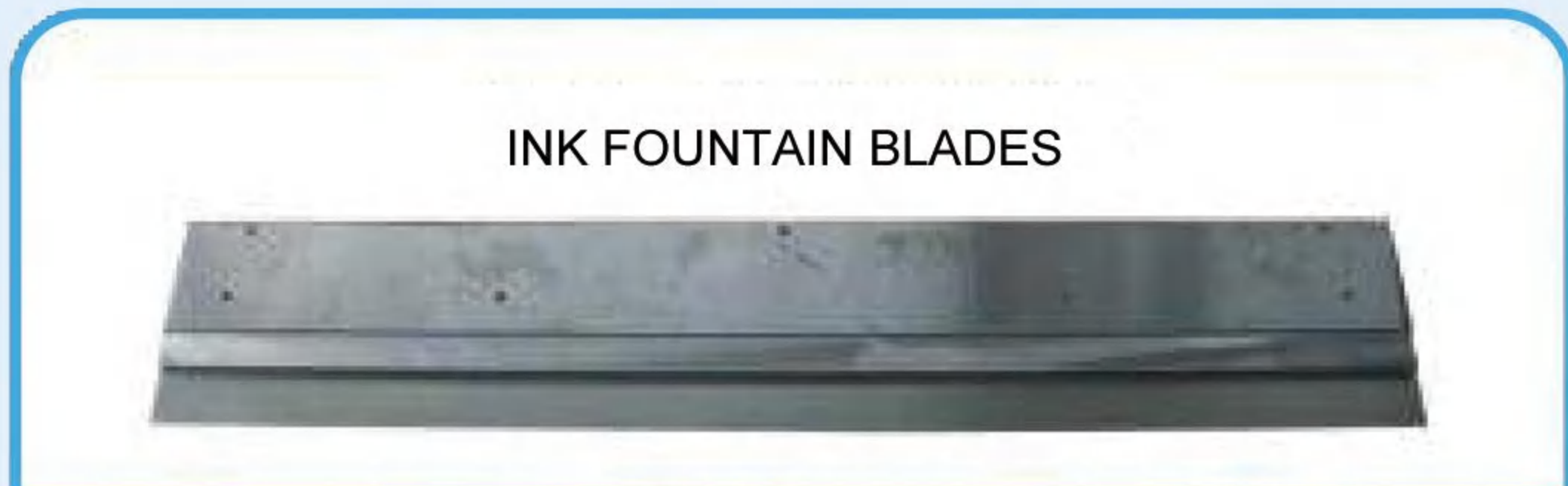
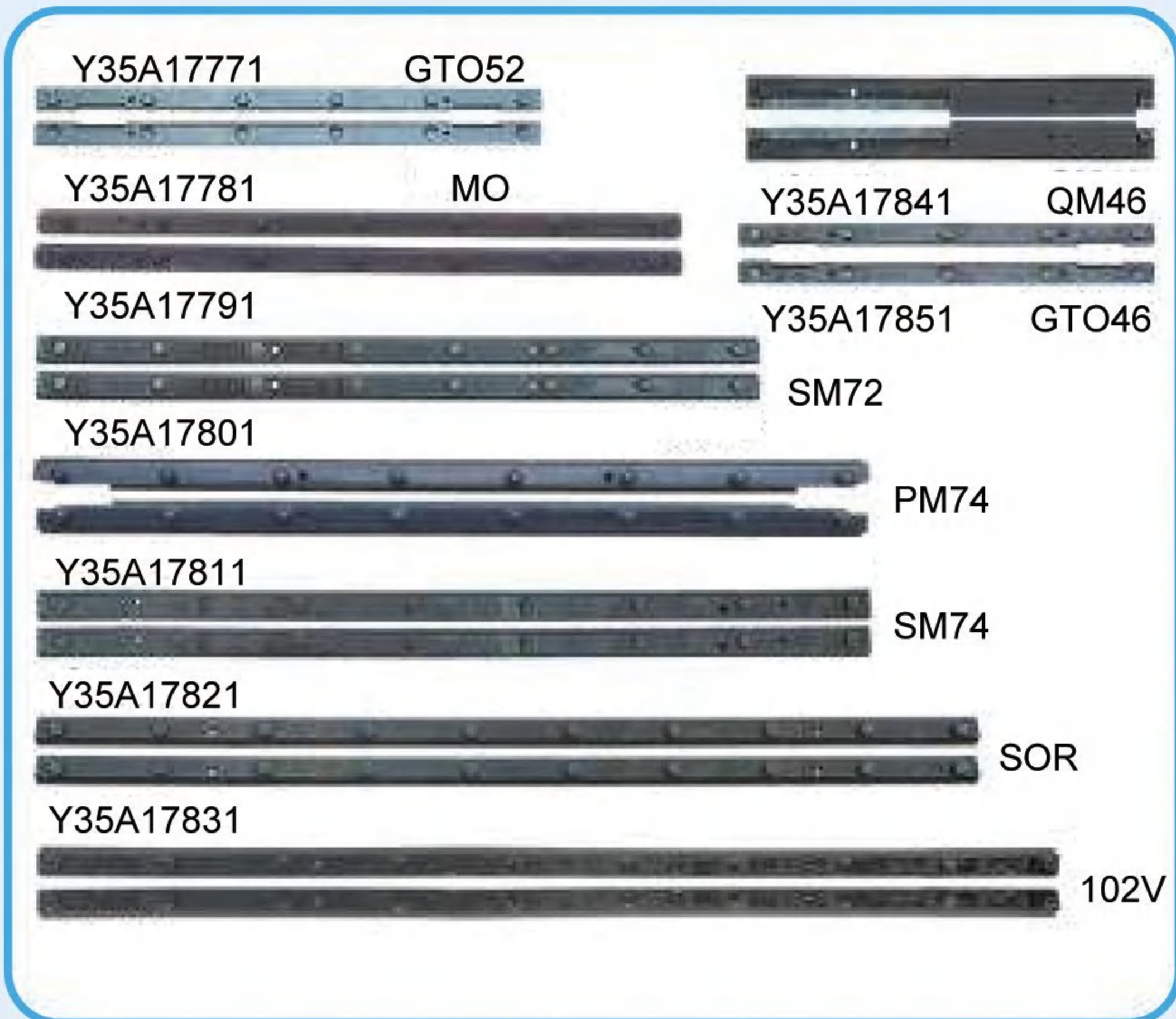

Code	Mode	Space
	Ink Fountain Blades	
Y 35A17861		375*1015mm
Y 35A17871	FOR GTO46	452*86mm
Y 35A17881	FOR GTO52	512*95mm
Y 35A17891	FOR MO65	662*1295mm
Y 35A17901	FOR KORD64	670*102mm
Y 35A17911	FOR KORD72	740*103mm
Y 35A17921	FOR SORM72	730*175mm
Y 35A17931	FOR SORM72	730*118mm
Y 35A17941	FOR SM74	747*135mm
Y 35A17951	FOR GSM102	1030*175mm

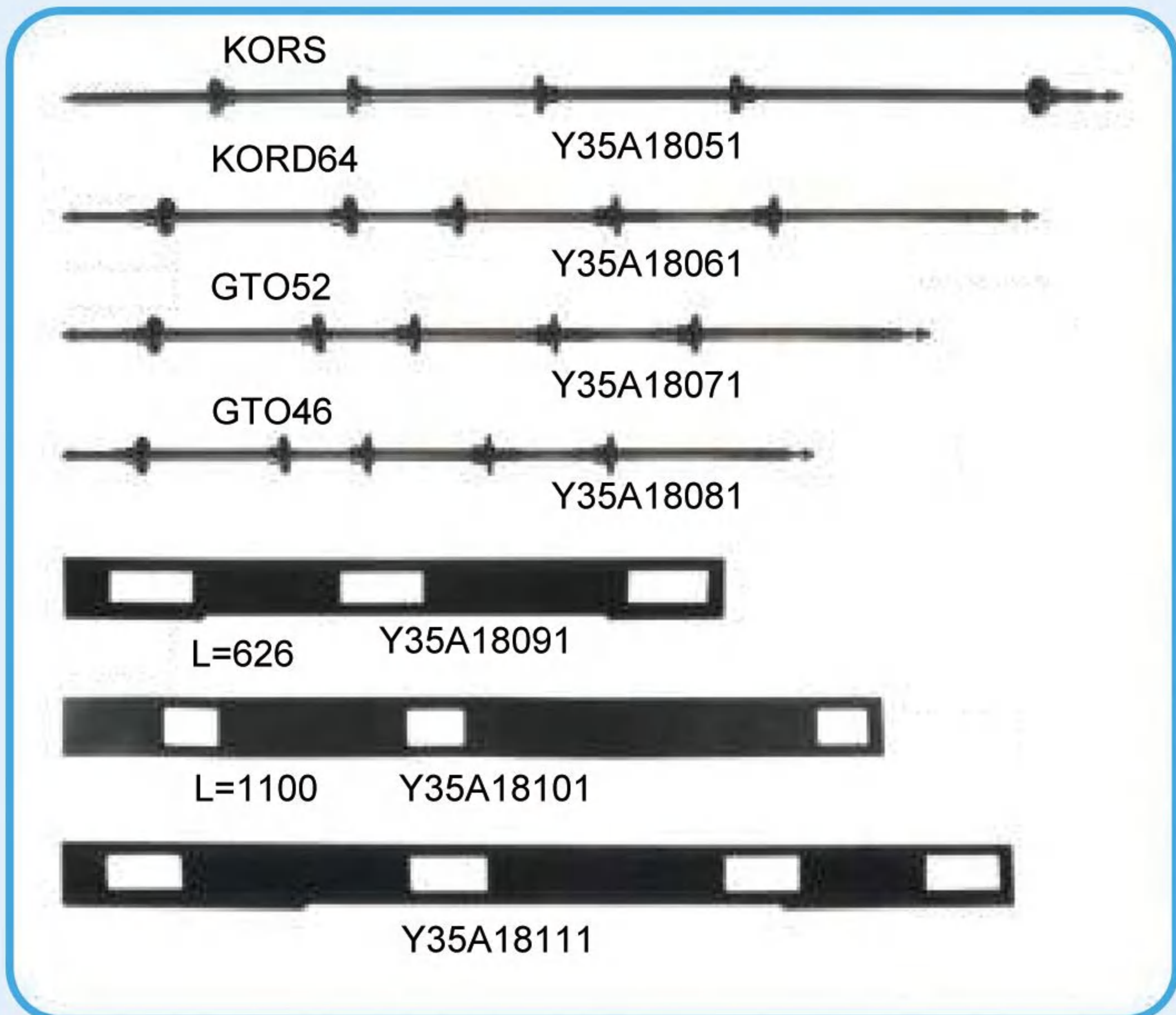



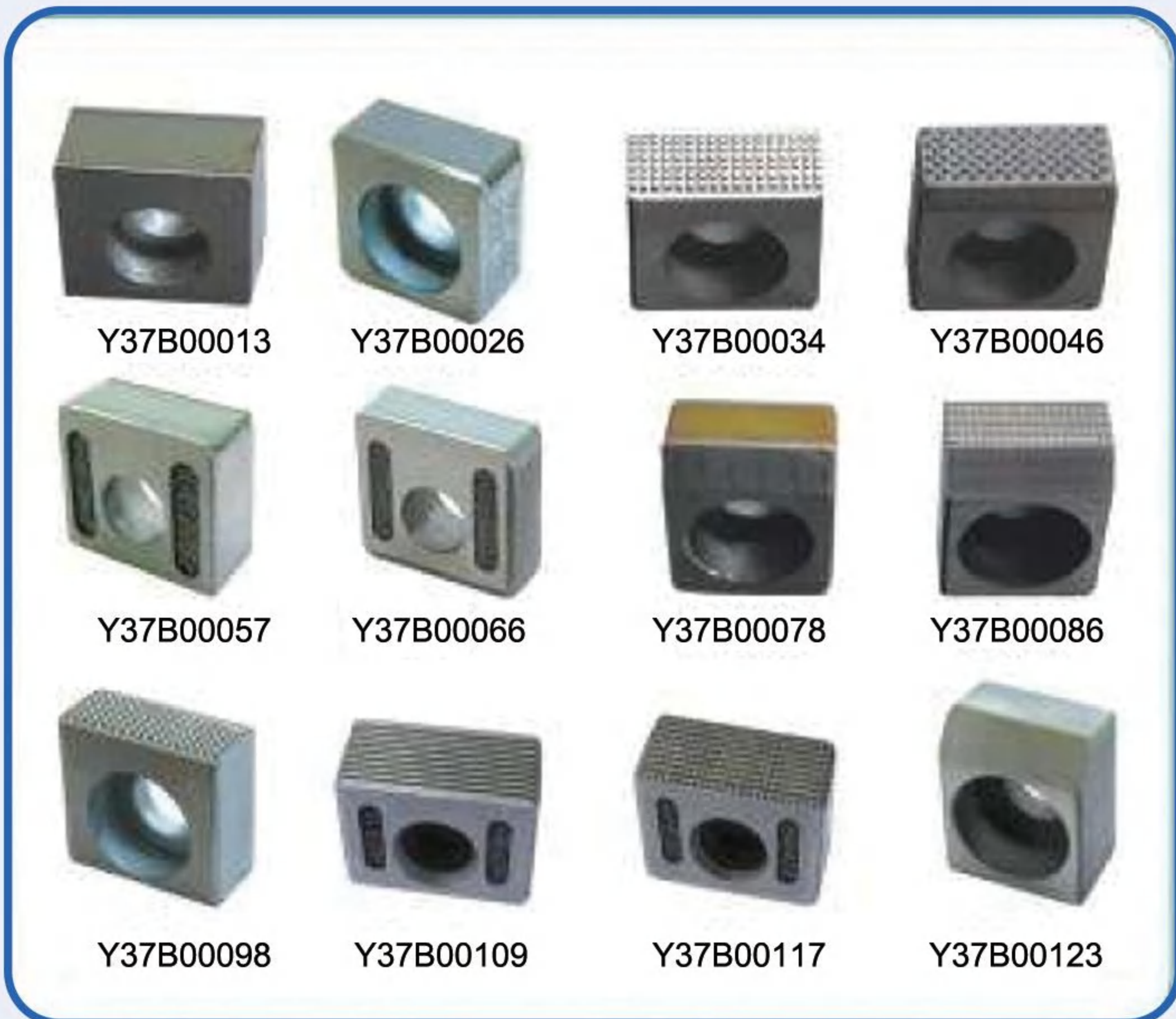





Y39B01451



Y39B01467



Y39B01470



Y39B01489



Y39B01491



Y39B01503



Y39B01515



Y39B01523



Y39B01534



Y39B01547



Y39B01552



Y39B01563



Y39B01571



Y39B01593



Y39B01613



Y39B01622



Y39B01630



Y39B01648



Y39B01653



Y39B01663



Y39B01602



Y39B01671



Y39B01680



Y39B01692



Y39B01708



Y39B01714



Y39B01726



Y39B01730



Y39B01742



Y39B01766



Y39B01775



Y39B01786



Y39B01799



Y39B01801



Y39B01813



Y39B01827



Y39B01836



Y39B01847



Y39B01853



Y39B01868



Y39B01874



Y39B01882



Y39B01893



Y39B01900



Y39B01912



Y39B01924



Y39B01936



Y39B01940



Y39B01951



Y39B01964



Y39B01978



Y39B01989



Y39B01993



Y39B02004



Y39B02016



Y39B02024



Y39B02035







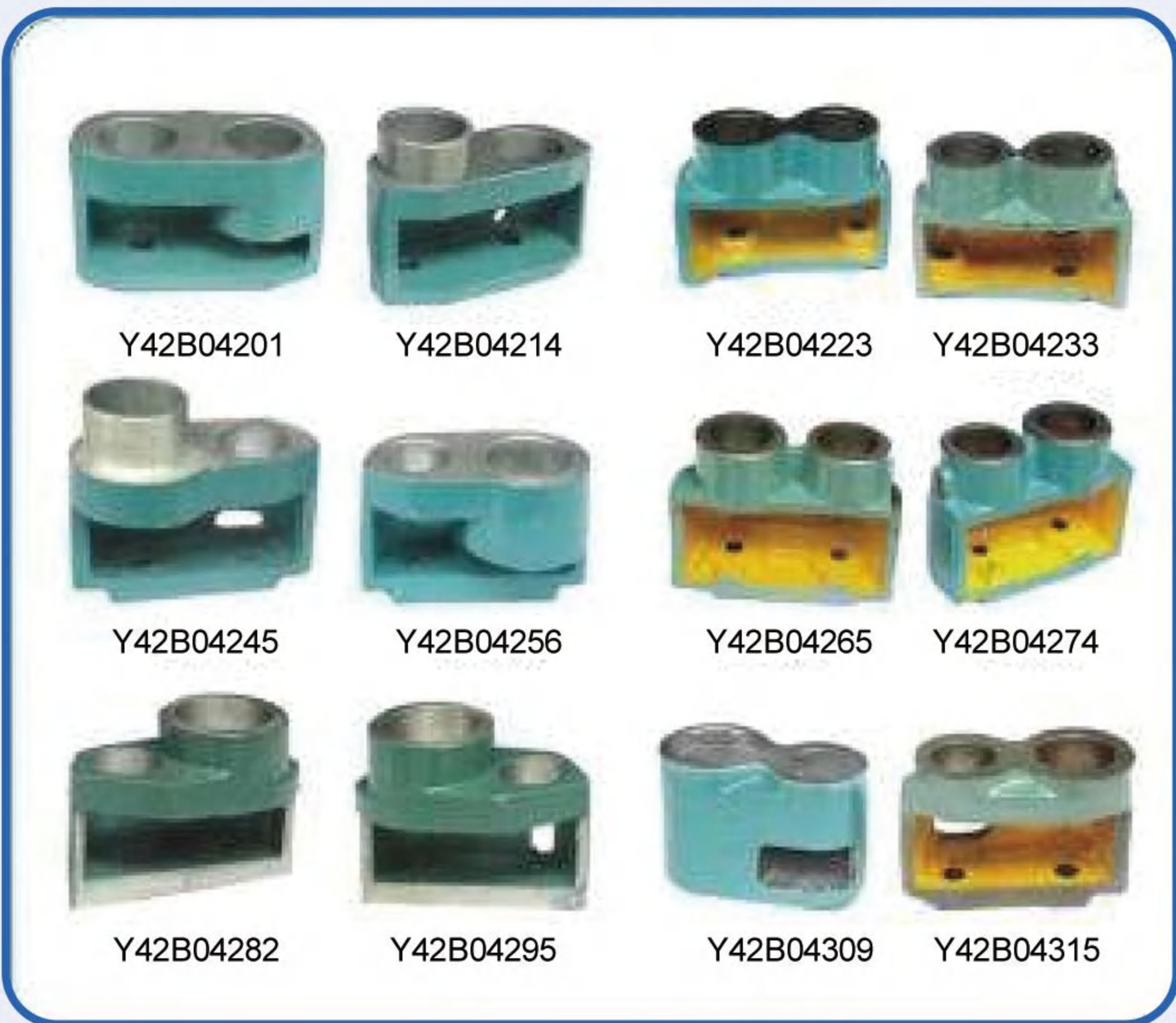





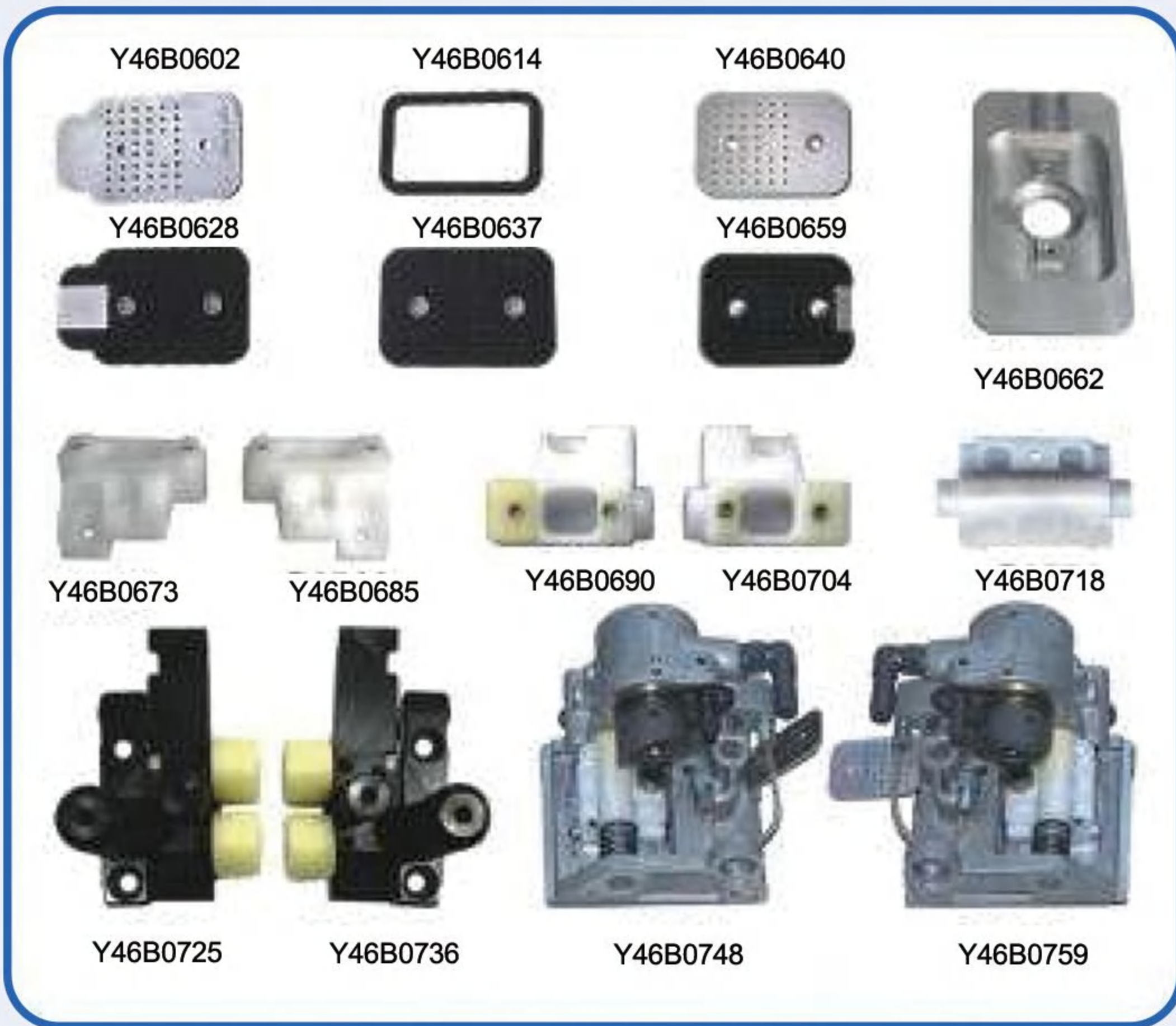







Code	Bearing number	Code	Bearing number
Y49B07652	5205	B0780	F8540
Y49B07661	6001	B0781	NA2204
Y49807672	6003	B0782	NA4901
Y49B07681	6004	B0783	NA4902
Y49B07691	8005	B0784	NA4903
Y49B06701	6010	B0785	NA4904
Y49B07711	6202	B0786	NA4919
Y49B07721	8203	B0787	NA6904
Y49B07732	6205	B0788	NATR12-DZ
Y49B07741	6904	B0789	NKJA5903
Y49B07751	6907	B0790	NKJA5904
Y49B07761	F17288	B0791	NK40/20
Y49B07771	F211687	B0792	NK24/16
Y49B07781	F21432	B0793	RNAFW203026
Y49B07791	F23835	B0794	32009CA



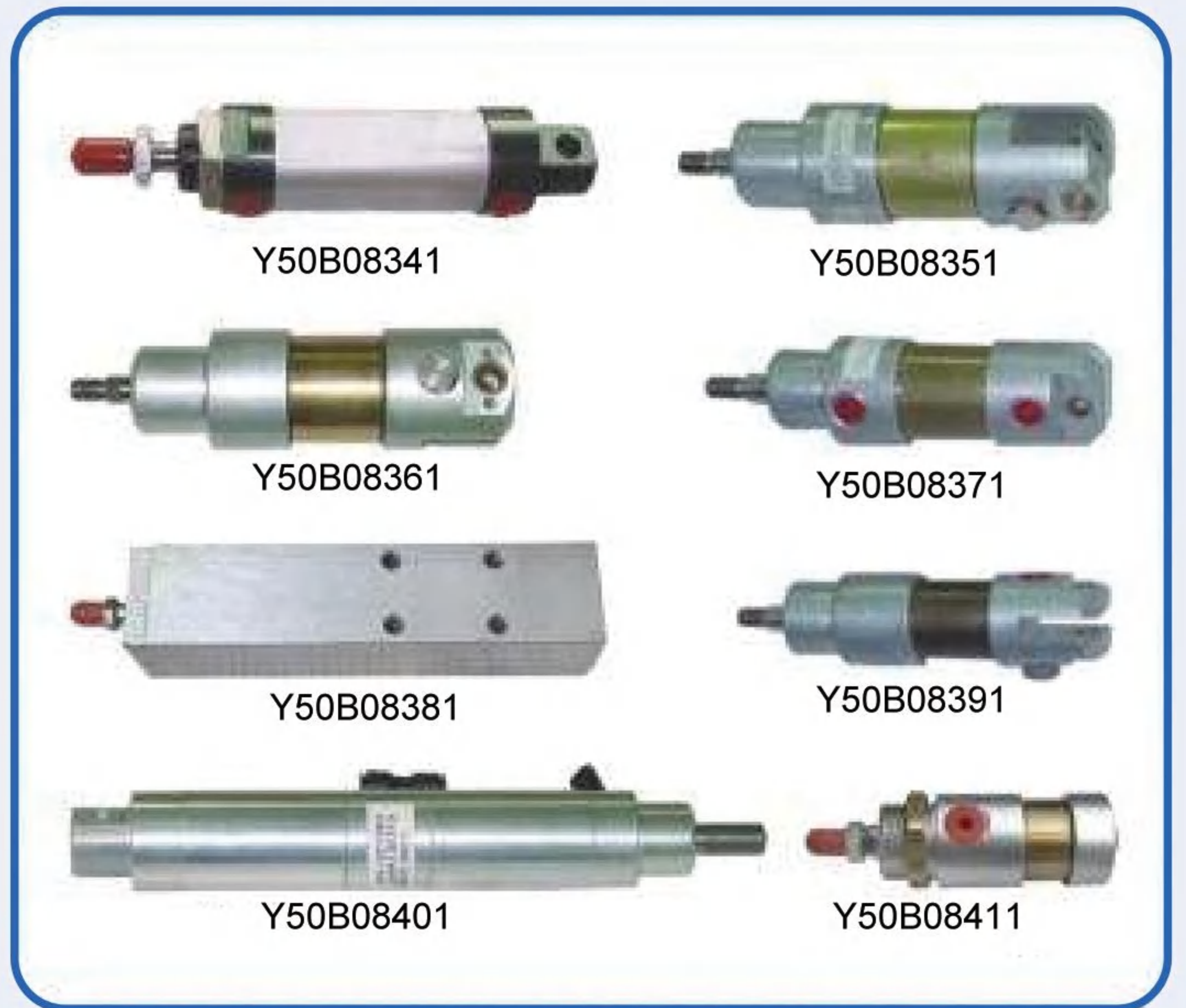











			
OD=64 ID=17 H=51 18teeth Y55B10731	OD=105 ID=25 H=20 33teeth Y55B10741	ID=30 H=16 24teeth Y55B10751	OD=59 ID=25 H=20 20teeth Y55B10761
			
OD=53 ID=25 H=20 19teeth Y55B10771	OD=53 ID=15 H=26 15 teeth Y55B10781	OD=81 ID=30 H=48 25teeth Y55B10791	OD=51 ID=25 H=21 14teeth Y55B10801
			
OD=35 ID=9 H=4 42teeth Y55B10811	OD=41 ID=20 H=13 18teeth Y55B10821	OD=52 ID=16 H=24 24teeth Y55B10831	OD=51 ID=16 H=21 14teeth Y55B10841

			
OD=55 ID=25.5 H=14 19teeth Y55B10851	OD=62 ID=25 H=20 30teeth Y55B10861	OD=71 ID=25 H=20 24teeth Y55B10871	OD=106 ID=40 H=20 40teeth Y55B10881
			
OD=67 ID=16 H=30 14teeth Y55B10891	OD=76 ID=30 H=30 22 teeth Y55B10901	OD=60 ID=20 H=18 28teeth Y55B10911	OD=87 ID=40 H=16 26teeth Y55B10921
			
OD=87 ID=25 H=17 26teeth Y55B10931	OD=51 ID=42 H=21 32teeth Y55B10941	OD=90 ID=30 H=15 27teeth Y55B10951	OD=84.5 ID=39 H=27 32teeth Y55B10961

			
OD=53 ID=19 H=28 23 TEETH Y55B10971	OD=134 ID=33 H=20 50 TEETH Y55B10981	OD=122 ID=37 H=18 33 TEETH Y55B10991	OD=75 ID=28 H=19 48 TEETH Y55B11001
			
OD=115 ID=35 H=17 31 TEETH Y55B11011	OD=97 ID=26 H=13 36 TEETH Y55B11021	OD=98 ID=5 1H=15 47 TEETH Y55B11031	OD=116 ID=45 H=42 35 TEETH Y55B11041
			
OD=128 ID=40 H=15 61 TEETH Y55B11051	OD=119 ID=40 H=15 57 TEETH Y55B11061	OD=134 ID=55 H=18 51 TEETH Y55B11071	OD=45 ID=14 H=26 28 TEETH Y55B11081

			
OD=123 ID=41 H=15 58 TEETH Y55B11091	OD=110 ID=26.58 H=17 40 TEETH Y55B11101	OD=106 ID=30 H=20 39 TEETH Y55B11111	OD=110 ID=26 H=12 42 TEETH Y55B11121
			
OD=127 ID=30 H=40 25+61 TEETH Y55B11131	OD=45 ID=20 H=38 16 TEETH Y55B11141	OD=44 ID=15 H=31 20 TEETH Y55B11151	OD=40 ID=10 H=19 25 TEETH Y55B11161
			
OD=86 ID=14 H=42 20 TEETH Y55B11171	OD=94 ID=50 H=14 28 TEETH Y55B11181	OD=105 ID=30 H=32 33 TEETH Y55B11191	OD=44 ID=14 H=20 20 TEETH Y55B11201

			
OD=100 ID=81 27 TEETH Y55B11211	OD=95 ID=18 30 TEETH Y55B11221	OD=34 ID=12 H=10 21 TEETH Y55B11231	OD=45 ID=15 H=12 26 TEETH Y55B11241
			
OD=46 ID=15 H=12 28 TEETH Y55B11251	OD=35 ID=10 32 TEETH Y55B11261	OD=33 ID=14 30 TEETH Y55B11271	OD=33ID=10 H=17 20 TEETH Y55B11281
			
OD=42 ID=10 H=21 27 TEETH Y55B11291	OD=154 ID=56 H=37 37 TEETH Y55B11301	OD=136 ID=28 H=28 44 TEETH Y55B11311	OD=136 ID=30 H=28 44 TEETH Y55B11321

			
OD=200 ID=25 H=36 36 TEETH Y55B11331	OD=200 ID=54 H=42 42 TEETH Y55B11341	OD=128 H=25 42 TEETH Y55B11351	OD=460 ID=340 H=271 108 TEETH Y55B11361
			
OD=119 ID=60 H=94 24 TEETH Y55B11371	OD=133ID=70 H=100 24 TEETH Y55B11381	OD=138 ID=60 H=92 24 TEETH Y55B11391	OD=460 ID=280 H=38 108 TEETH Y55B11401
			
OD=95 ID=22 H=34 32 TEETH Y55B11411	OD=134 ID=35 H=33 32 TEETH Y55B11421	OD=134 ID=50 H=68 32 TEETH Y55B11431	OD=105 ID=50 H=93 23 TEETH Y55B11441

 OD=97 ID=48 H=110 28 TEETH Y56B11451	 OD=136 ID=50 H=84 33 TEETH Y56B11461	 OD=395 ID=195 H=90 57 TEETH Y56B11471	 110 TEETH Y56B11481
 OD=306 ID=170 H=51 88 TEETH Y56B11491	 OD=384 ID=172 H=92 84 TEETH Y56B11501	 OD=288 ID=118 H=65 71 TEETH Y56B11511	 OD=288 ID=190 H=45 71 TEETH Y56B11521
 OD=395 ID=220 H=70 92 TEETH Y56B11531	 OD=393 ID=218 H=78 119 TEETH Y56B11541	 OD=306 ID=210 H=45 88 TEETH Y56B11551	 OD=306 ID=90 H=50 88 TEETH Y56B11561

 OD=172 ID=76 H=120 51 TEETH Y56B11571	 OD=395 ID=220 H=70 92 TEETH Y56B11581	 OD=222 ID=63 H=63 72 TEETH Y56B11591	 OD=320 ID=110 H=120 74 TEETH Y56B11601
 OD=289 ID=30 H=65 71 TEETH Y56B11611	 OD=138 ID=25 H=67 44 TEETH Y56B11621	 OD=122 ID=70 H=107 42 TEETH Y56B11631	 OD=185 ID=20 60 TEETH Y56B11641
 OD=305 ID=210 H=38 88 TEETH Y56B11651	 OD=395 ID=220 H=90 92 TEETH Y56B11661	 OD=395 ID=220 H=70 92 TEETH Y56B11671	 OD=394 ID=276 H=65 92 TEETH Y56B11681

 OD=185 ID=50 H=28 60 TEETH Y56B11691	 OD=305 ID=168 H=50 88 TEETH Y56B11701	 OD=287 ID=170 H=51 71 TEETH Y56B11711	 OD=285 ID=90 H=22 112 TEETH Y56B11721
 OD=258 ID=25 H=30 84 TEETH Y56B11731	 OD=256 ID=49 H=32 84 TEETH Y56B11741	 OD=248 ID=30 H=78 61 TEETH Y56B11751	 OD=305 ID=170 H=57 108 TEETH Y56B11761
 OD=282 ID=124 H=65 71 TEETH Y56B11771	 OD=305 ID=210 H=46 88 TEETH Y56B11781	 OD=305 ID=59 108 TEETH Y56B11791	 OD=306 ID=170 H=50 86 TEETH Y56B11801

 OD=395 ID=275 H=65 92 TEETH Y56B11811	 OD=272 ID=50 H=35 83 TEETH Y56B11821	 OD=306 ID=170 H=45 88 TEETH Y56B11831	 OD=306 ID=170 H=50 88 TEETH Y56B11841
 OD=306 ID=100 H=50 88 TEETH Y56B11851	 OD=30 ID=16 H=30 25 TEETH Y56B11861	 OD=55 ID=20 H=36 16 TEETH Y56B11871	 OD=52 ID=16 H=36 25 TEETH Y56B11881
 OD=68 ID=25 H=42 21 TEETH Y56B11891	 OD=48 ID=28 H=35 15 TEETH Y56B11901	 OD=40 ID=18 H=50 14 TEETH Y56B11911	 OD=61.5 ID=20 H=27 30 TEETH Y56B11921

 OD=62.5 ID=42 H=33 19 TEETH Y56B11931	 OD=56 ID=25 H=44 27 TEETH Y56B11941	 OD=63 ID=20 H=30 30 TEETH Y56B11951	 OD=45 ID=28 H=34.5 14 TEETH Y56B11961
 OD=63 ID=25 H=40 21 TEETH Y56B11971	 OD=62.5 ID=242 H=33 18 TEETH Y56B11981	 OD=58 ID=26 H=40 19 TEETH Y56B11991	 OD=63 ID=40 H=35 19 TEETH Y56B12001
 OD=63 ID=40 H=36 19 TEETH Y56B12011	 OD=68 ID=47 H=33 21 TEETH Y56B12021	 OD=75 ID=47 H=32 25 TEETH Y56B12031	 OD=74 ID=4 H=34 24 TEETH Y56B12041

 OD=86.5 ID=42 20 TEETH Y56B12051	 OD=68.5 ID=242 H=30 21 TEETH Y56B12061	 OD=71 ID=47 H=32 22 TEETH Y56B12071	 OD=77.5 ID=55 H=37 24 TEETH Y56B12081
 OD=61.5 ID=25 H=27 30 TEETH Y56B12091	 OD=68 ID=24 H=25 19+21 TEETH Y56B12101	 OD=71.5 ID=42 H=34 22 TEETH Y56B12111	 OD=65 ID=24 H=50 18+20 TEETH Y56B12121
 OD=68 ID=30 H=44 21 TEETH Y56B12131	 OD=60 ID=25 H=34 18 TEETH Y56B12141	 OD=78.5 ID=30 H=38 25 TEETH Y56B12151	 OD=72 ID=42 H=33.5 22 TEETH Y56B12161

 OD=88 ID=47 H=32 27teeth Y57B12171	 OD=86 ID=45 H=32 27teeth Y57B12181	 OD=80 ID=47 H=52 38teeth Y57B12191	 OD=88 ID=60 H=32 29teeth Y57B12201
 OD=85 ID=47 H=32 27teeth Y57B12211	 OD=86 ID=50 H=32 27teeth Y57B12221	 OD=54 ID=30 H=32 27teeth Y57B12231	 OD=63.5 ID=30 H=32 27teeth Y57B12241
 OD=45.5 ID=14 H=121 14teeth Y57B12251	 OD=51 H=94 16teeth Y57B12261	 ID=20 H=30 22teeth Y57B12271	 OD=71 ID=25 H=50 27teeth Y57B12281

 OD=57 ID=15 H=12 20teeth Y57B12291	 OD=50 ID=28 H=25 18teeth Y57B12301	 OD=63 ID=25 H=37 24teeth Y57B12311	 OD=96 ID=30 H=30 30teeth Y57B12321
 OD=95 ID=25 H=25 30teeth Y57B12331	 OD=116 ID=50 H=30 26teeth Y57B12341	 OD=88 ID=40 H=28 41teeth Y57B12351	 OD=66.5 ID=42 H=36.5 21teeth Y57B12361
 OD=74 ID=45 H=55 21teeth Y57B12371	 OD=66 ID=35 H=30 30teeth Y57B12381	 OD=74 ID=32 H=50 21teeth Y57B12391	 OD=80.5 ID=47 H=41 25teeth Y57B12401

 OD=77.5 ID=42 H=33 24teeth Y57B12411	 OD=99.5 ID=42 H=39 34teeth Y57B12421	 OD=80.5 ID=47 H=20 25teeth Y57B12431	 OD=85.5 ID=47 H=39 29teeth Y57B12441
 OD=85 ID=25 H=39 29teeth Y57B12451	 OD=85.5 ID=25 H=34 29teeth Y57B12461	 OD=86.5 ID=45 H=32 27teeth Y57B12471	 OD=66.5 ID=45 H=25 27teeth Y57B12481
 OD=103 ID=07 H=24 50teeth Y57B12491	 OD=83 ID=60 H=66 26teeth Y57B12501	 OD=83 ID=50 H=87 25teeth Y57B12511	 OD=86 ID=65 H=34 30teeth Y57B12521

 OD=130 ID=80 H=65 36teeth Y57B12531	 OD=85.5 ID=42 H=55 29teeth Y57B12541	 OD=86.5 ID=25 H=55 28teeth Y57B12551	 OD=87.5 ID=52 H=65 25teeth Y57B12561
 OD=91 ID=60 H=54.5 31teeth Y57B12571	 OD=130 H=85 38teeth Y57B12581	 OD=105 ID=30 H=28 40teeth Y57B12591	 OD=103 ID=62 H=65 30teeth Y57B12601
 OD=80.5 H=102 25teeth Y57B12611	 OD=71 ID=13 H=107 27teeth Y57B12621	 OD=78.5 H=192 25teeth Y57B12631	 OD=62 ID=13 H=107 24teeth Y57B12641

 OD=138 ID=50 H=50 44teeth Y57B12651	 OD=108 ID=30 H=49 35teeth Y57B12661	 OD=109 ID=30 H=46 35teeth Y57B12671	 OD=108 ID=30 H=46 33teeth Y57B12681
 OD=108 ID=30 H=50 33teeth Y57B12691	 OD=108 ID=50 H=45 35teeth Y57B12701	 OD=145 ID=47 H=25 40teeth Y57B12711	 OD=111 ID=65 H=20 35teeth Y57B12721
 OD=100 ID=72.5 H=27 30teeth Y57B12731	 OD=111 ID=24 H=37 35teeth Y57B12741	 OD=108 ID=28 H=115 35teeth Y57B12751	 OD=108 ID=28 H=106 33teeth Y57B12761

 OD=108 ID=30 H=100 33teeth Y57B12771	 OD=108 ID=30 H=110 35teeth Y57B12781	 OD=108 ID=25 H=112 35teeth Y57B12811	 OD=105 ID=50 H=80 40teeth Y57B12821
 OD=85 ID=62 H=91 29teeth Y57B12831	 OD=77 ID=53 H=113 24teeth Y57B12841	 OD=77 ID=55 H=113 24teeth Y57B12851	 OD=91 ID=45 H=125 31teeth Y57B12861
 OD=90.5 ID=45 H=108 31teeth Y57B12871	 OD=85 ID=45 H=102 29teeth Y57B12881	 OD=86 ID=28 H=100 29teeth Y57B12891	 OD=113 ID=45 H=105 35teeth Y57B12901

 OD=91 ID=45 H=125 31teeth Y58B12912	 OD=91 ID=55 H=102 31teeth Y58B12922	 OD=85.5 ID=45 H=92 29teeth Y58B12932	 OD=121 ID=60 H=112 42teeth Y58B12942
 OD=123 ID=46 H=119 36teeth Y58B12952	 OD=123 ID=45 H=130 36teeth Y58B12962	 OD=123 ID=115 H=119 36teeth Y58B12972	 OD=122 ID=60 H=126 42teeth Y58B12982
 OD=102 ID=45 H=140 30teeth Y58B12992	 OD=104 ID=55 H=42 49teeth Y58B13002	 OD=62 ID=42 H=20 29teeth Y58B13012	 OD=58 ID=28 H=35 18teeth Y58B13022

 OD=52 ID=28 H=17 24teeth Y58B13032	 OD=95 ID=40 H=55 22teeth Y58B13042	 OD=45 ID=26 H=25 28teeth Y58B13052	 OD=66 ID=35 H=30 20teeth Y58B13062
 OD=35 ID=18 H=30 12teeth Y58B13072	 OD=77.5 ID=42 H=30 24teeth Y58B13082	 OD=33 ID=18 H=20 19teeth Y58B13092	 OD=34 ID=12 H=20 16teeth Y58B13102
 OD=74 ID=47 H=34 24teeth Y58B13112	 OD=138 ID=70 H=35.5 44teeth Y58B13122	 OD=131.5 ID=50 H=30 42teeth Y58B13132	 OD=95 ID=22 H=33.5 33teeth Y58B13142

 OD=142.5 ID=47 H=32 50teeth Y58B13152	 OD=152 ID=47 H=32 53teeth Y58B13162	 OD=156 ID=25 H=40 50teeth Y58B13172	 OD=110 ID=40 H=50 32teeth Y58B13182
 OD=112 ID=63 H=55 34teeth Y58B13192	 OD=195 ID=80 H=25 70teeth Y58B13202	 OD=148 ID=47 H=32 52teeth Y58B13212	 OD=153 ID=25 H=74 44teeth Y58B13222
 OD=245 ID=120 H=65 35teeth Y58B13232	 OD=153 ID=35 H=62.5 36teeth Y58B13242	 OD=166 ID=25 H=46 60teeth Y58B13252	 OD=198 ID=28 H=45 64teeth Y58B13262

 OD=186 ID=72 H=25 60teeth Y58B13272	 OD=136 ID=60 H=90 33teeth Y58B13282	 OD=198 ID=85 H=28 64teeth Y58B13292	 OD=28 ID=120 H=64 56teeth Y58B13302
 OD=228 ID=115 H=35 56teeth Y58B13312	 OD=228 ID=130 H=35 56teeth Y58B13322	 OD=228 ID=130 H=35 56teeth Y58B13332	 OD=225 ID=34 H=31 65teeth Y58B13342
 OD=235 ID=120 H=70 54teeth Y58B13352	 OD=235 ID=120 H=70 54teeth Y58B13362	 OD=226 ID=93 H=53 70teeth Y58B13372	 OD=247 ID=145 H=36 61teeth Y58B13382

 OD=222 ID=90 H=67 70teeth Y58B13392	 OD=178 ID=110 H=70teeth Y58B13402	 OD=145 ID=90 H=73 35 40teeth Y58B13412	 OD=212 ID=50 H=95 66teeth Y58B13422
 OD=201 ID=80 H=88 60teeth Y58B13432	 OD=195 ID=90 H=86 51teeth Y58B13442	 OD=195 ID=140 H=32 76teeth Y58B13452	 OD=86.5 ID=45 H=26teeth Y58B13462
 OD=201 ID=122 H=90 46teeth Y58B13472	 OD=245 ID=85 H=41.5 48teeth Y58B13482	 OD=257 ID=25 H=30 84teeth Y58B13492	 OD=226 ID=32 H=30 76teeth Y58B13502

 OD=227 ID=33 H=52 76teeth Y58B13512	 OD=247 ID=140 H=35 61teeth Y58B13522	 OD=170 ID=25 H=45 44+11teeth Y58B13532	 OD=395 ID=220 H=70 92teeth Y58B13542
 OD=170 ID=40 H=55 56teeth Y58B13552	 OD=170 ID=25 H=45 44teeth Y58B13562	 OD=247 ID=140 H=36 51teeth Y58B13572	 OD=295 ID=115 H=23 92teeth Y58B13582
 OD=230 ID=40 H=64 56teeth Y58B13592	 OD=120 ID=69 H=55 28teeth Y58B13602	 OD=295 ID=115 H=25 92teeth Y58B13612	 OD=295 ID=155 H=25 92teeth Y58B13622



Y59B13631 Y59B13643 Y59B13656 Y59B13667
 Y59B13672 Y59B13688 Y59B13694 Y59B13705
 Y59B13719 Y59B13722 Y59B13736 Y59B13744



CODE	SPECS
Y59B13796	Roland alcohol tank short belt, W16
Y59B13801	Roland alcohol tank long belt, W10
Y59B13812	Roland alcohol tank long belt, W12
Y59B13825	Roland alcohol tank long belt, W16
Y59B13836	Roland alcohol tank long belt(OPTIBELT-T10)

Y59B13751
 Y59B13764
 Y59B13778
 Y59B13789



CODE	OD	ID	H
Y59B13847	170mm	164mm	118mm
Y59B13856	160mm	145mm	117mm
Y59B13861	160mm	145mm	102mm
Y59B13873	143mm	129mm	112mm
Y59B13889	125mm	110mm	82mm
Y59B13892	120mm	130mm	120mm
Y59B13901	102mm	110mm	100mm
Y59B13912	100mm	130mm	120mm
Y59B13923	100mm	90mm	93mm
Y59B13936	99mm	130mm	120mm
Y59B13945	82mm	130mm	120mm
Y59B13957	82mm	120mm	110mm
Y59B13964	54mm	36mm	24mm



Y59B13974
 Y59B13986
 Y59B13992
 Y59B14005
 Y59B14012
 Y59B14025

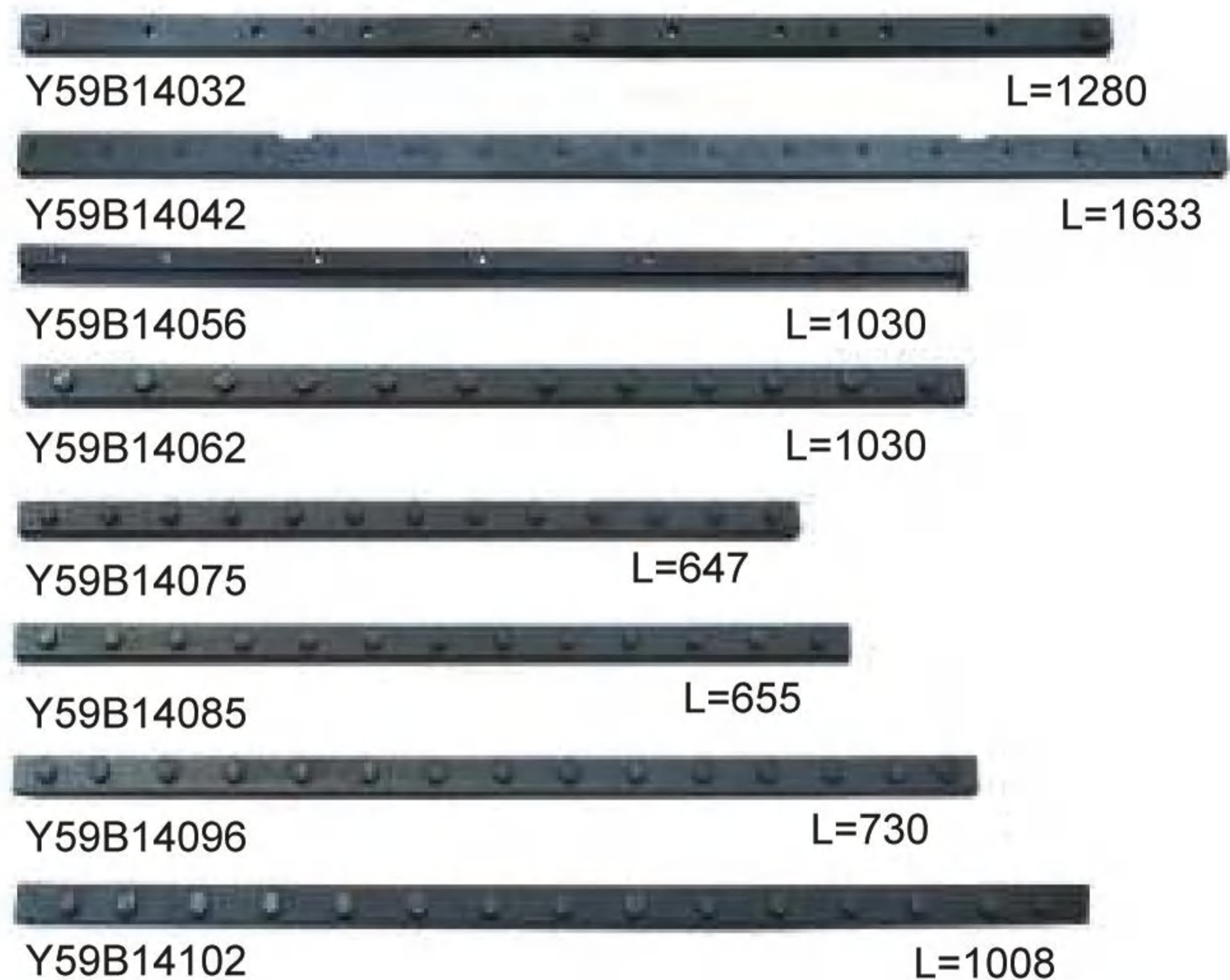

Y59B14032 L=1280
 Y59B14042 L=1633
 Y59B14056 L=1030
 Y59B14062 L=1030
 Y59B14075 L=647
 Y59B14085 L=655
 Y59B14096 L=730
 Y59B14102 L=1008



Y59B14115 L=923
 Y59B14127
 Y59B14136 L=1280
 Y59B14148 L=1035
 Y59B14151 L=840
 Y59B14168 L=975
 Y59B14173 L=1340
 Y59B14182 L=1422
 Y59B14191 L=1065

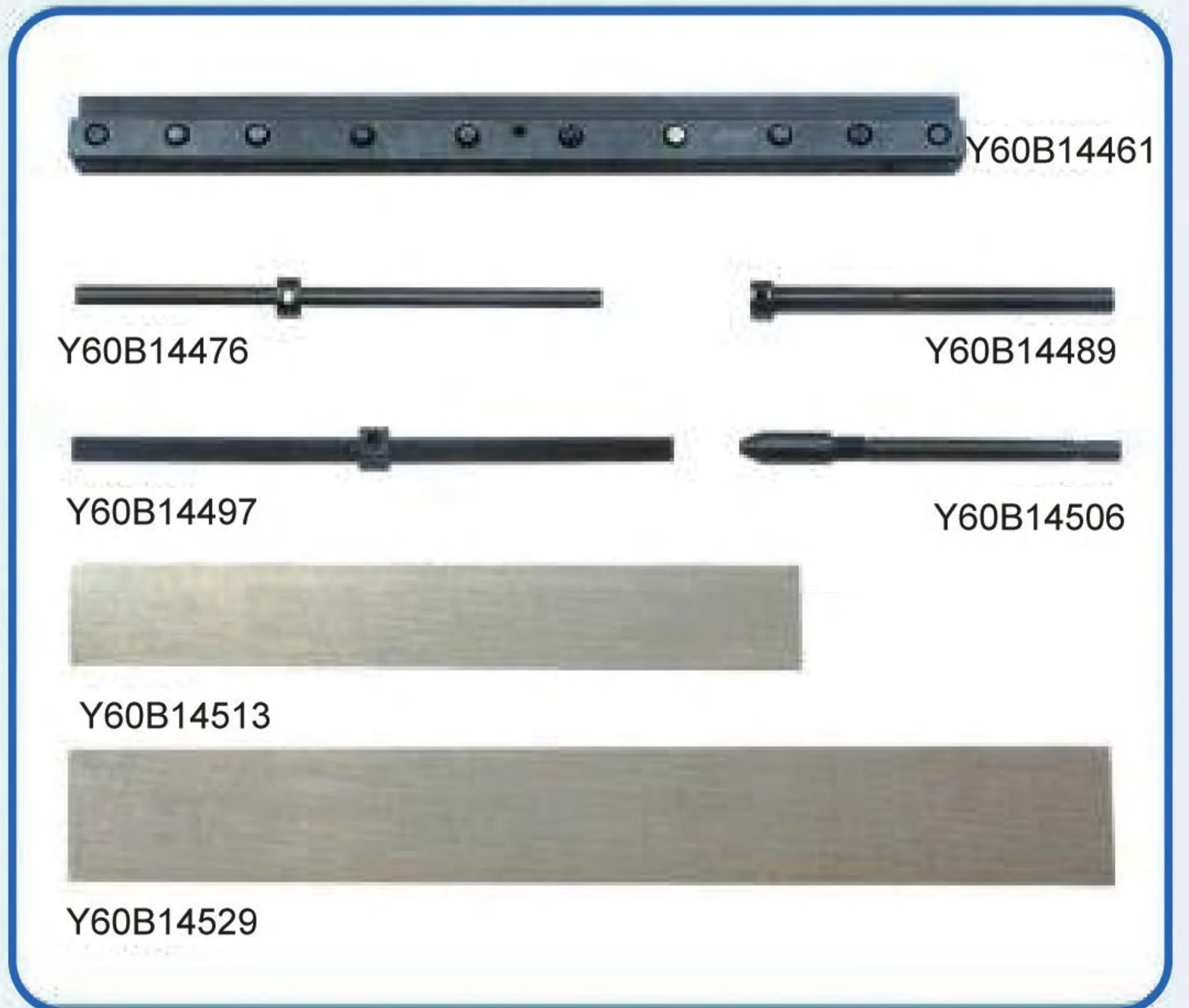









Y64B15815

Y64B15824



Y64B15839

Y64B15844



Y64B15851

Y64B15868



Y64B15873

Y64B15884



Y64B15894



Y64B15901



Y64B15915



Y64B15927



Y64B15934



Y64B15948



Y64B15951



Y64B15966



Y64B15972



Y64B15987



Y64B15996



Y64B16001



Y64B16018



Y64B16024



Y64B16035



Y64B16041



Y64B16057



Y64B16063



Y64B16071



Y64B16084



Y64B16095



Y64B16108



Y64B16114



Y65B16122



Y65B16136



Y65B16147



Y65B16156



Y65B16161



Y65B16179



Y65B16189



Y65B16191



Y65B16204



Y65B16214 Y65B16223



Y65B16237



Y65B16247



Y65B16258



Y65B16261



Y65B16279



Y65B16281 Y65B16296



Y65B16301



Y65B16312



Y65B16325



Y65B16336



Y65B16347



Y65B16351



Y65B16369



Y65B16375



Y65B16381



Y65B16392



Y65B16405



Y65B16411





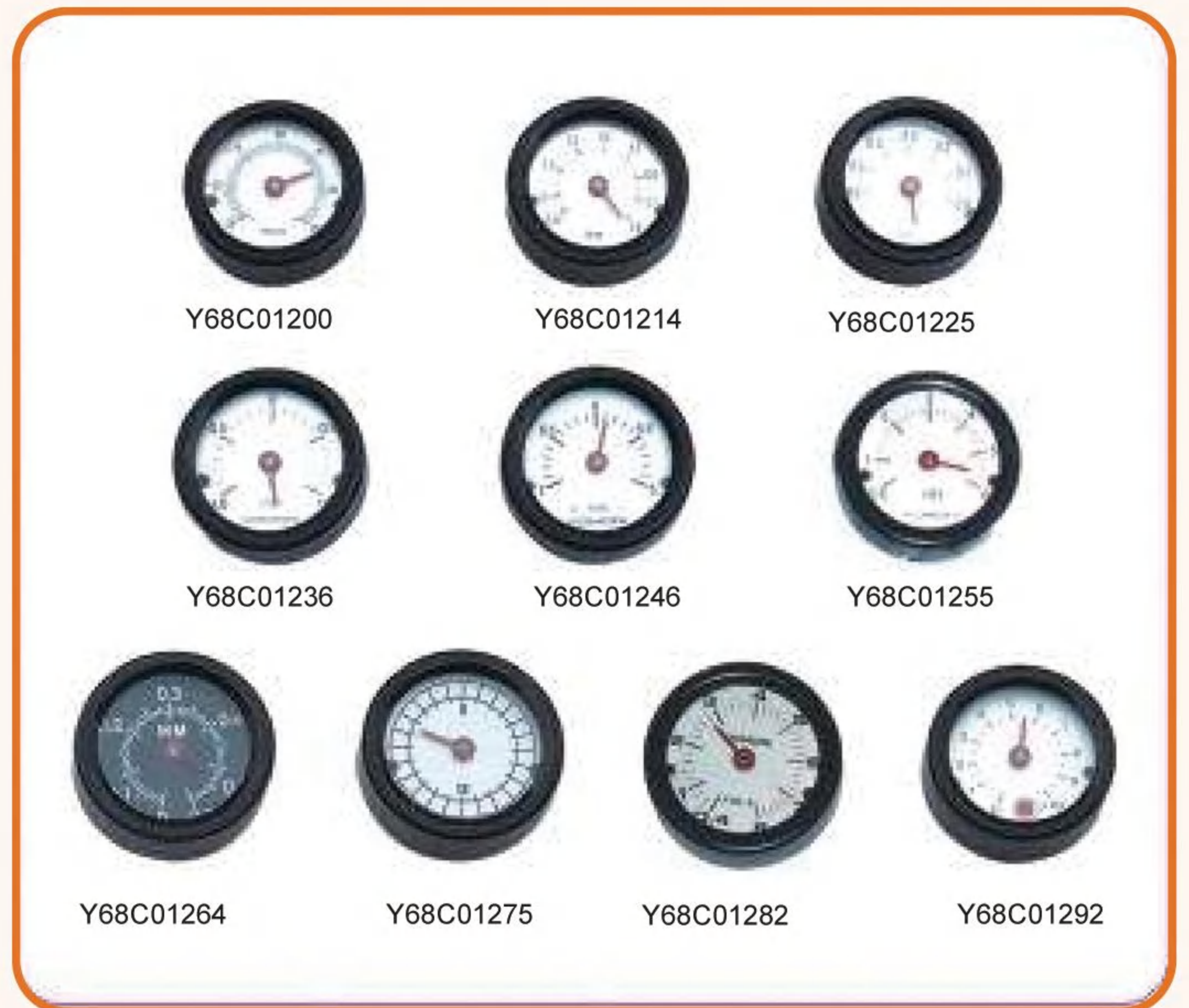



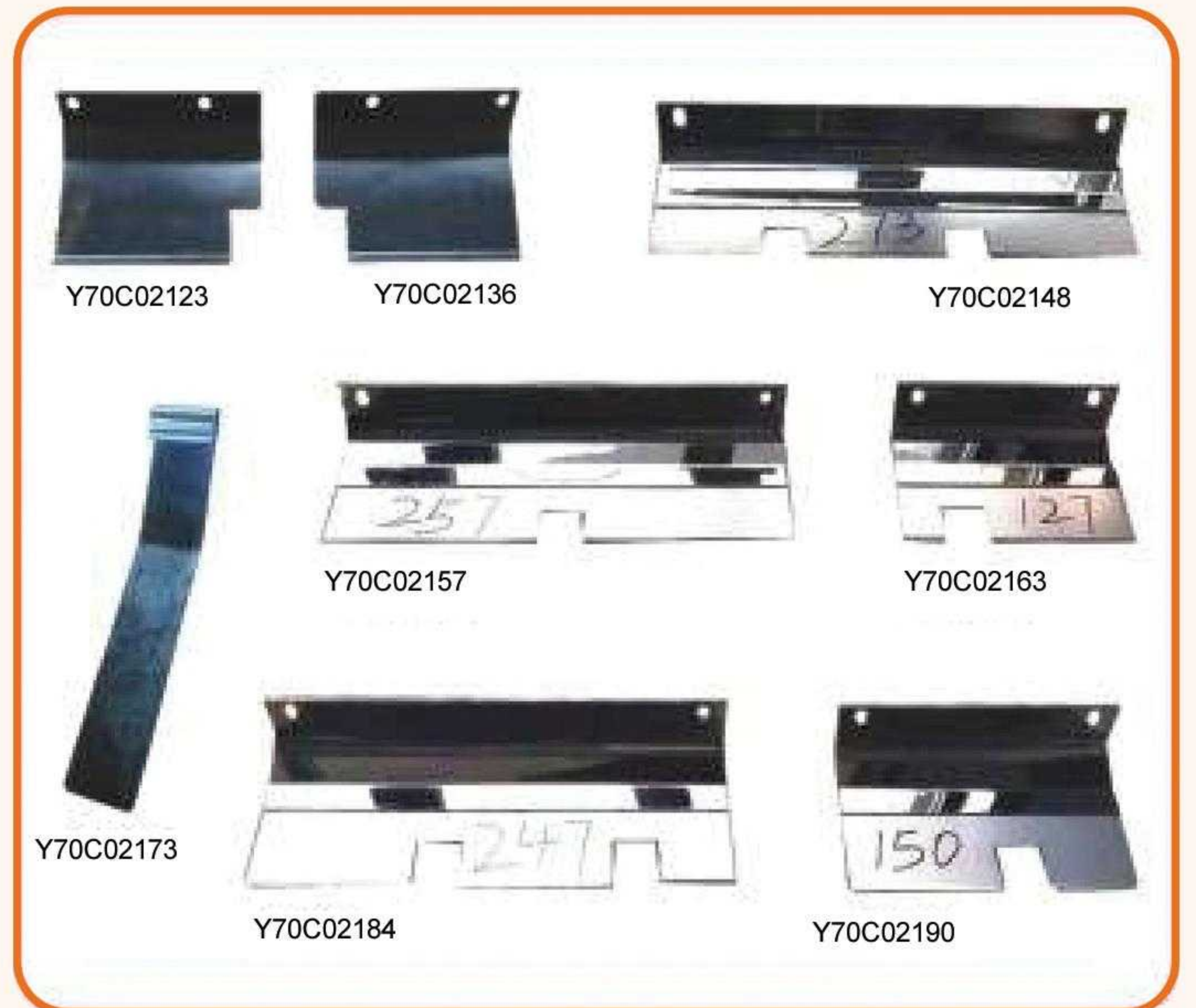

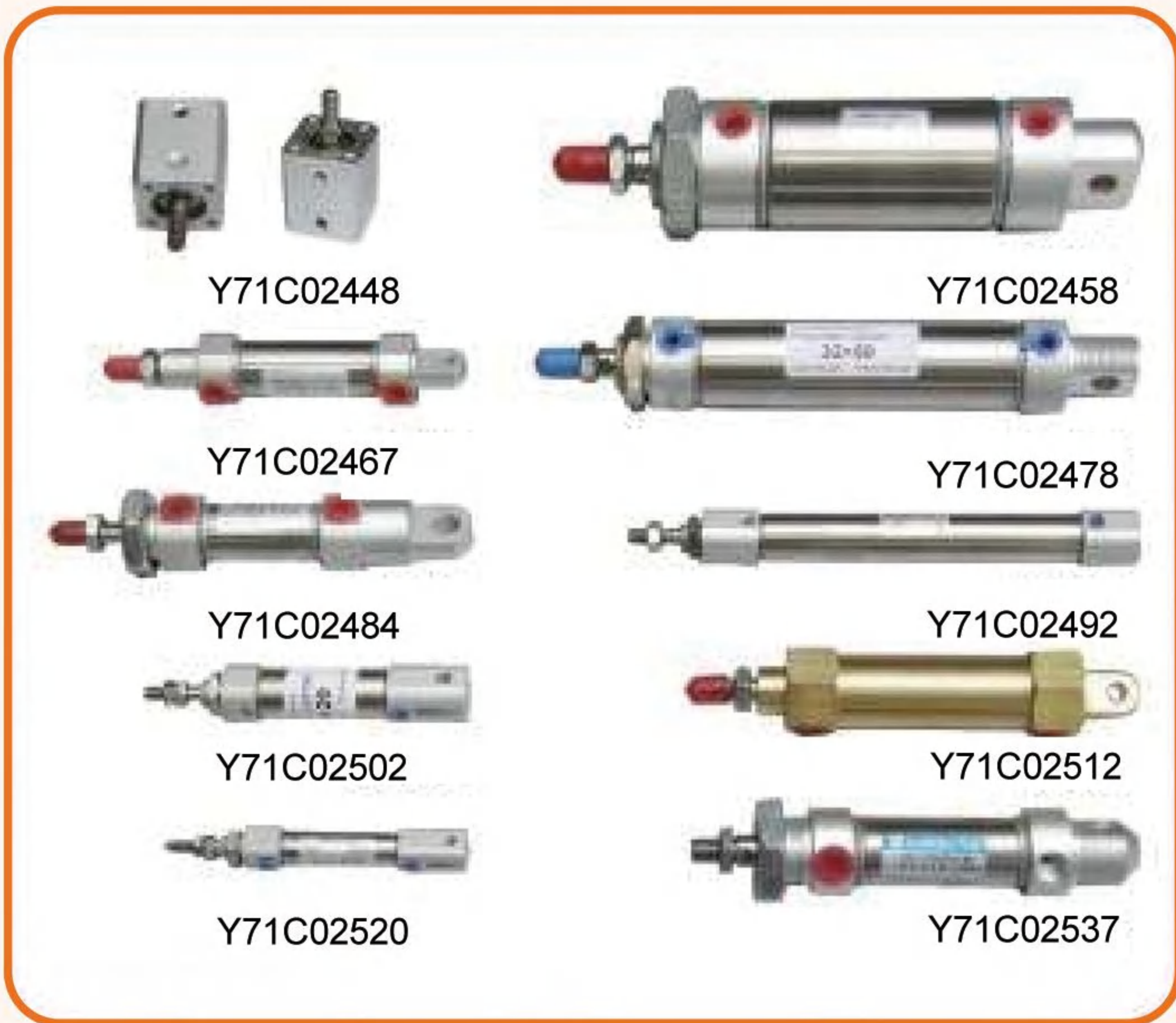

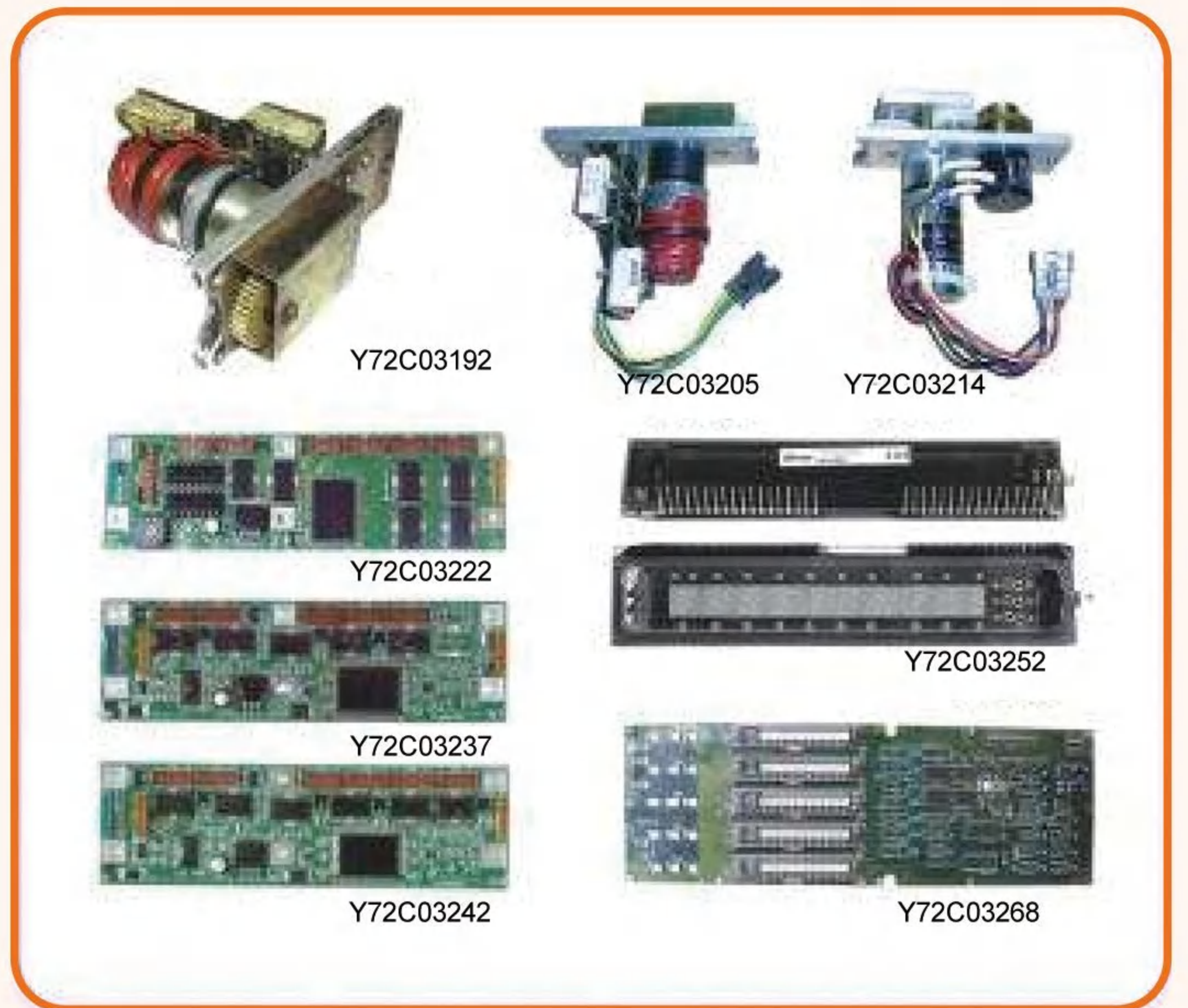
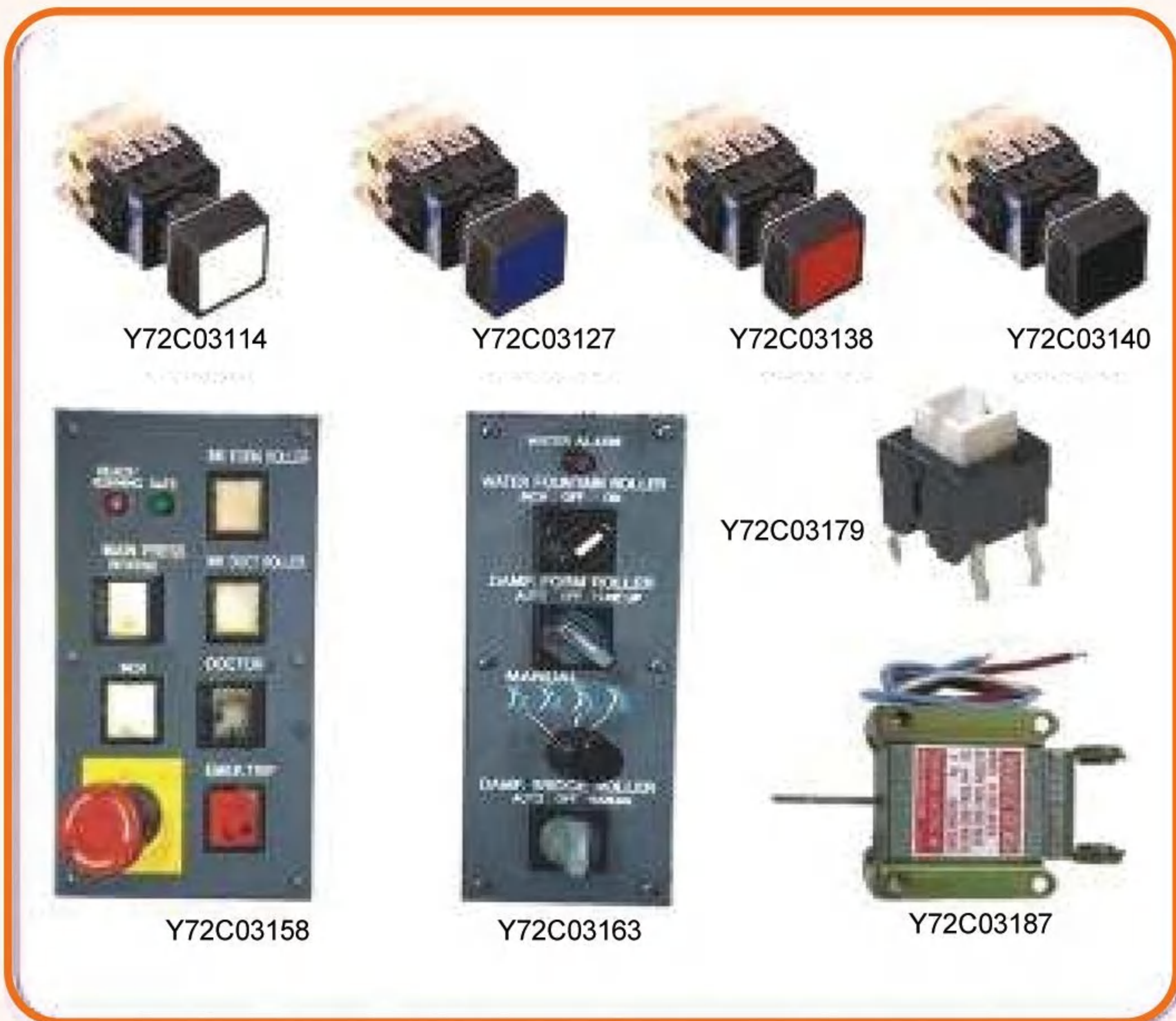





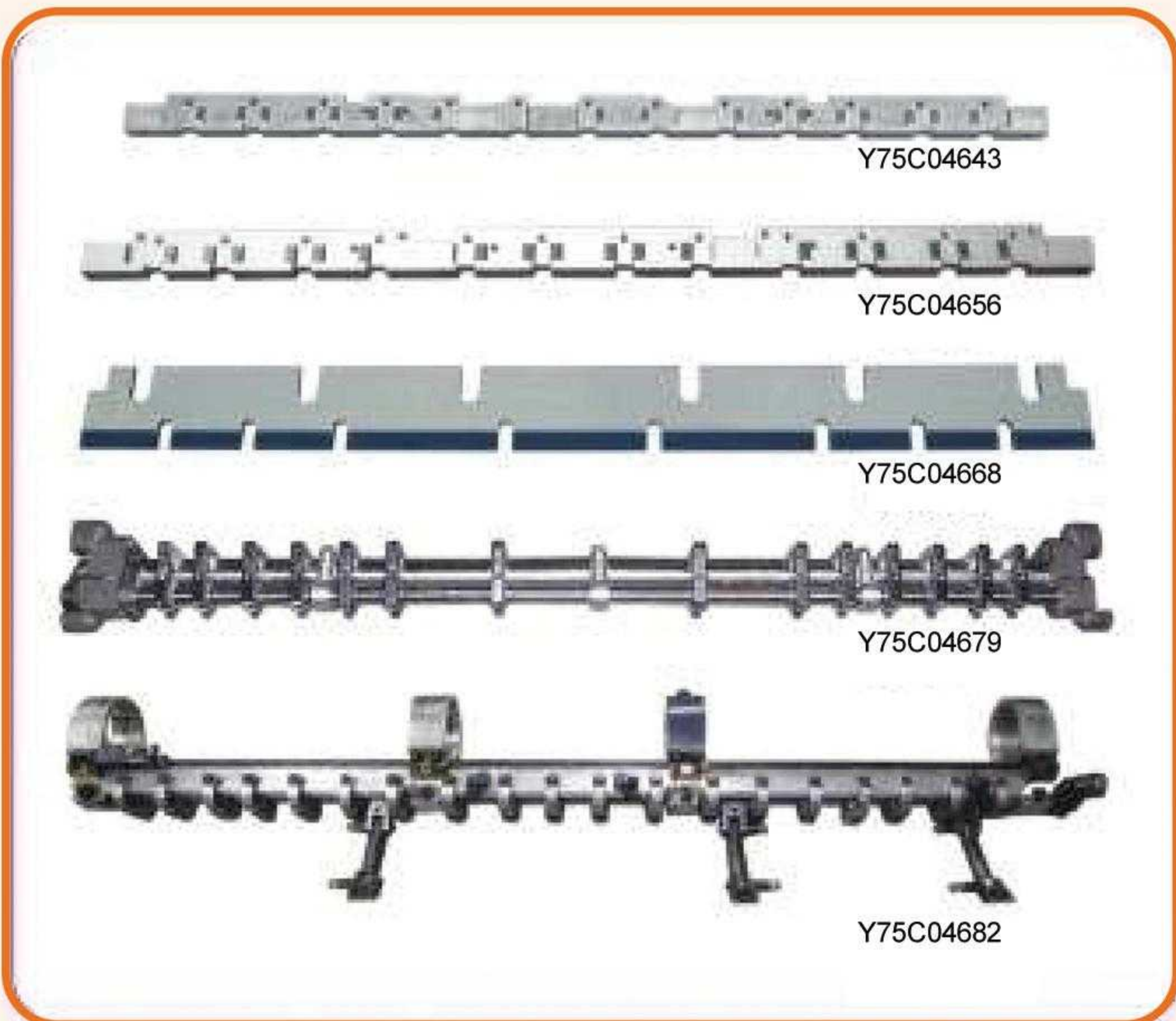
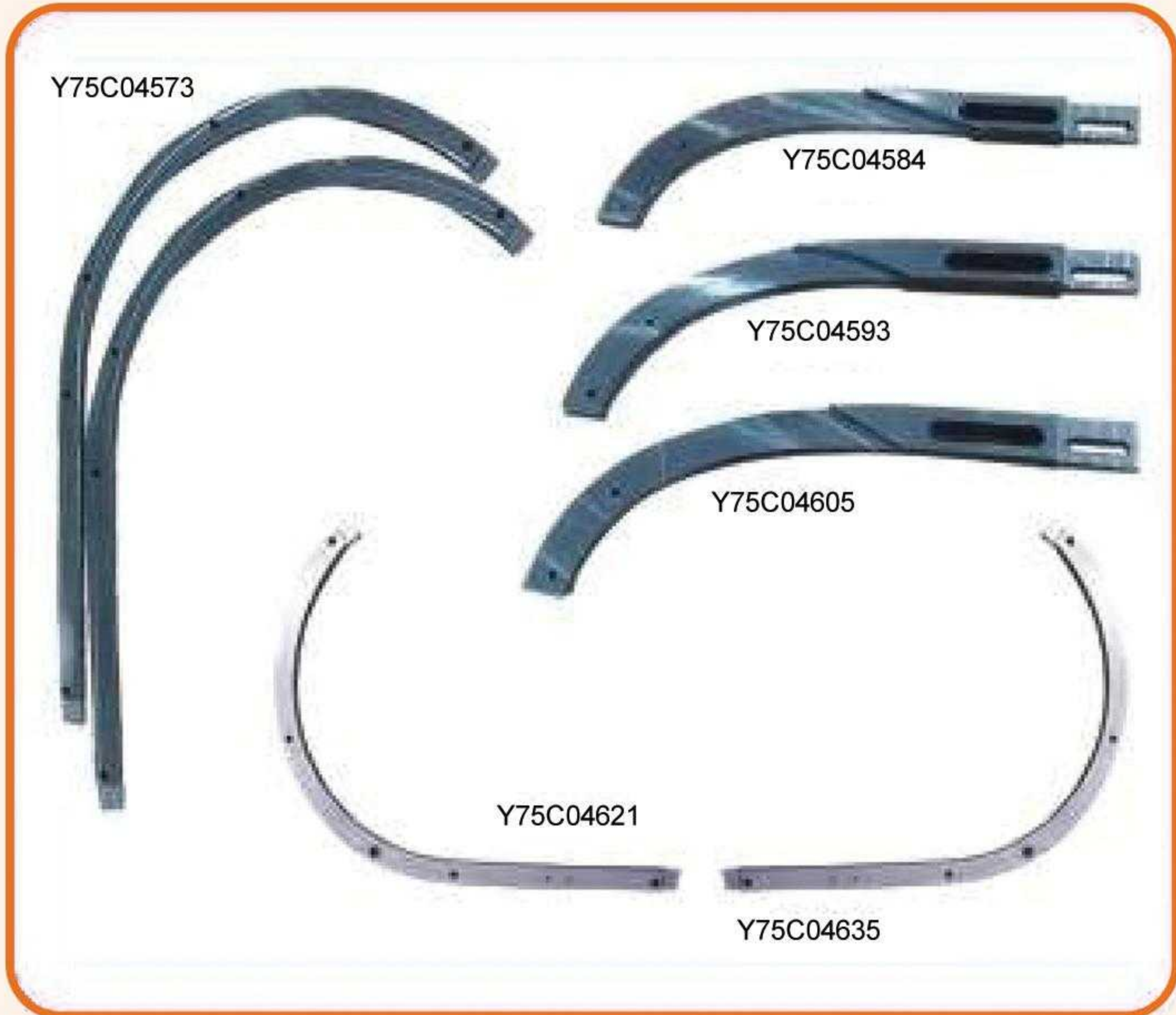









YE7900558



YE7900568



YE7900578



YE7900588



YE7900598



YE7900608



YE7900618



YE7900628



YE7900638



YE7900648



YE7900658



YE7900668



YE7900678



YE7900688



YE79800698



YE7900708



YE7900718



YE7900728



YE7900738



YE7900748



YE7900758



YE7900768



YE7900778



YE7900788



YE7900798



YE7900908



YE7900818



YE7900828



YE7900838



YE7900848



YE00558



YE00558



YE00558



YE7900888



YE7900898



YE7900908



YE7900918



YE7900928



YE7900938



YE7900948



YE7900958



YE7900968



YE9700978



YE7900988



YE7900998



YE7901008



YE7901018



YE7901028



YE7901048



YE7901048



YE7901058



YE7901068



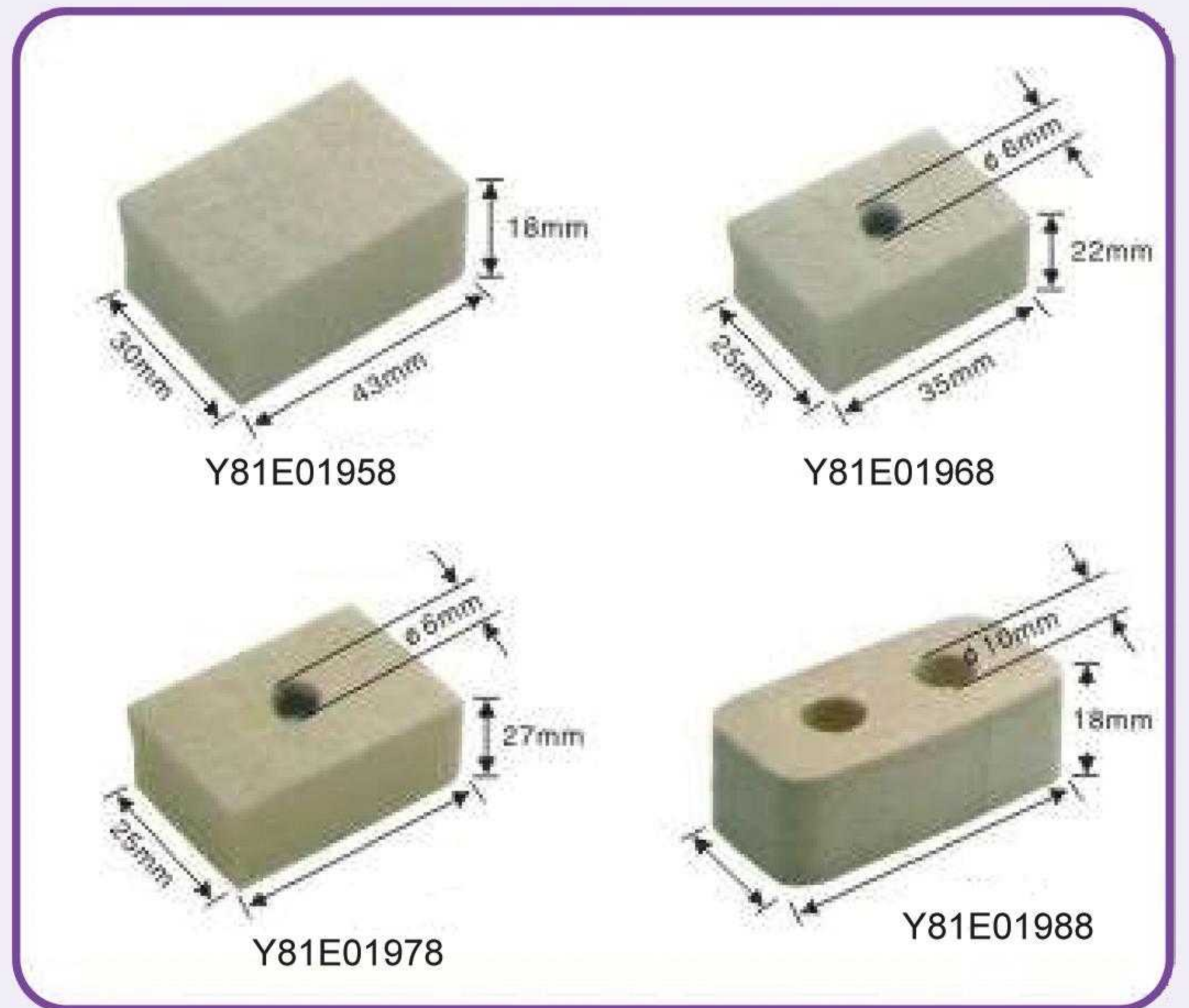
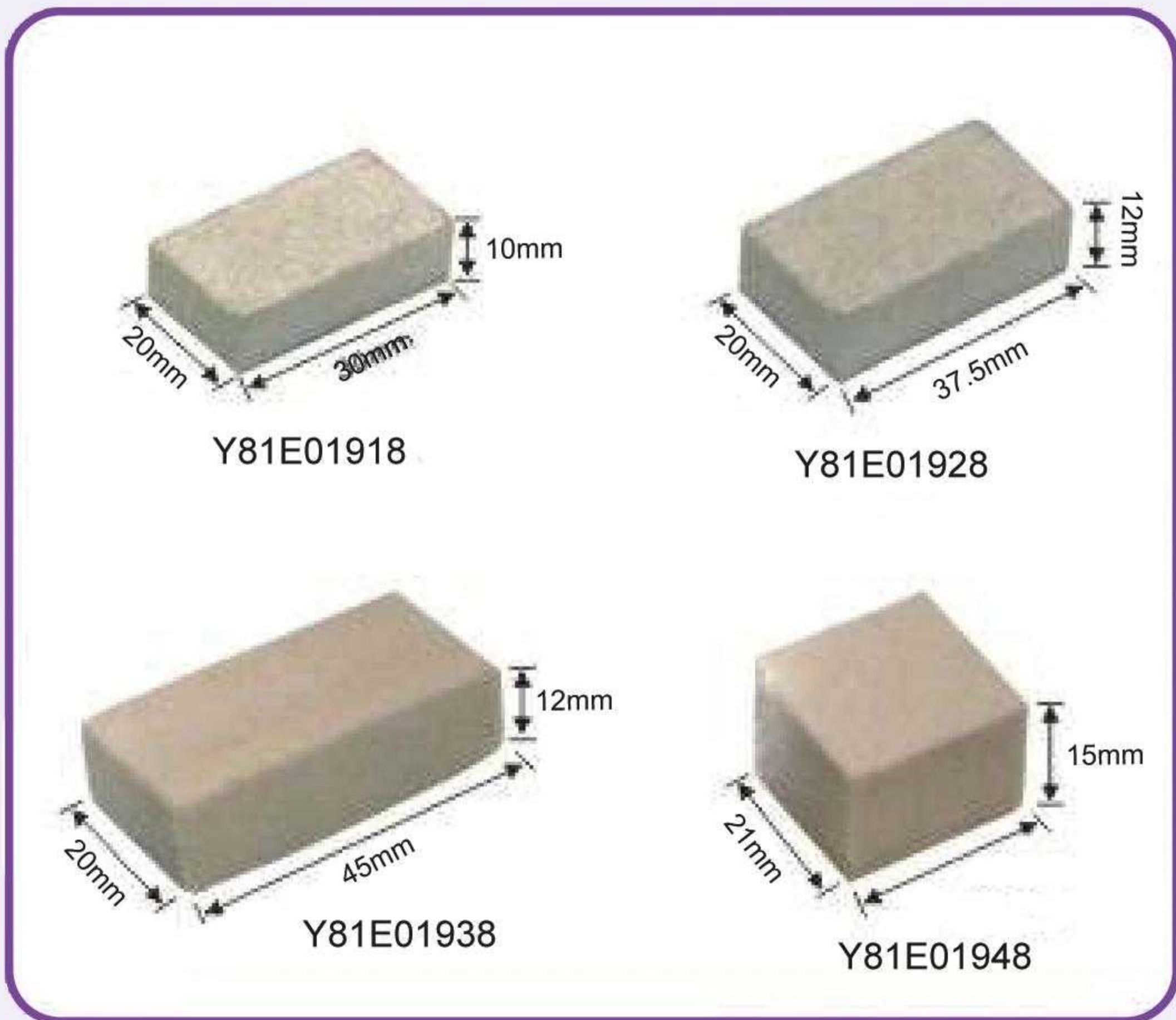
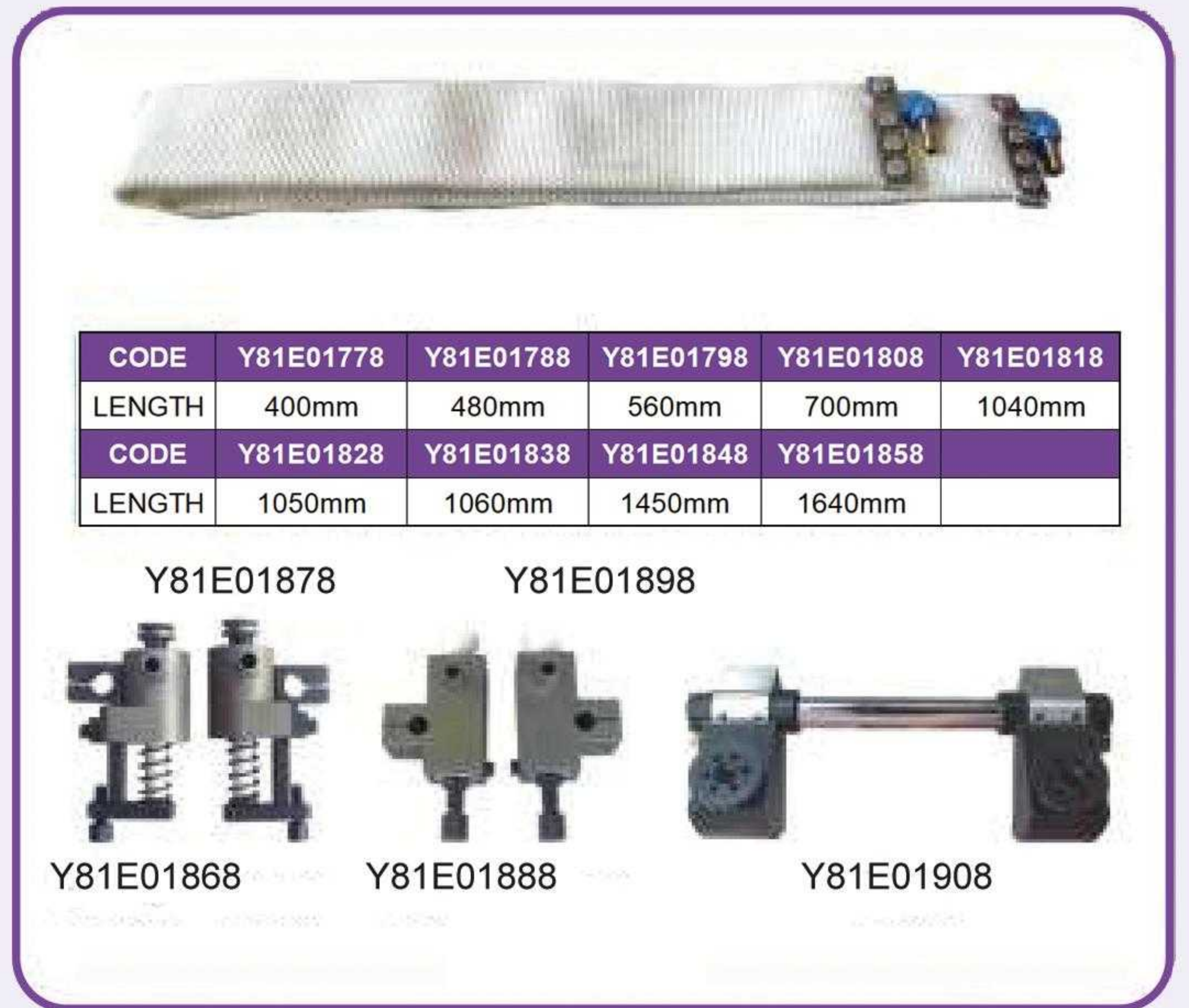



Y82E01998

Y82E02008

Y82E02018



Y82E02028

Y82E02038

Y82E02048



Y82E02058

Y82E02068

Y82E02078

Y82E02088



Y82E02008



Y82E02108



Y82E02118



Y82E02128



Y82E02138



Y82E02148



Y82E02158



Y82E02168



Y82E02178



Y82E02188



Y82E02198



Y82E02208



Y82E02218



Y82E02228



Y82E02238



Y82E02248



Y82E02288

Y82E02298

Y82E02288

Y82E02298



Y82E02298



Y82E02308



Y82E02318



Y82E02328



Y82E02338



Y82E02348



Y82E02358



Y82E02368



Y82E02378

EISI® Folding Machine Spare Parts

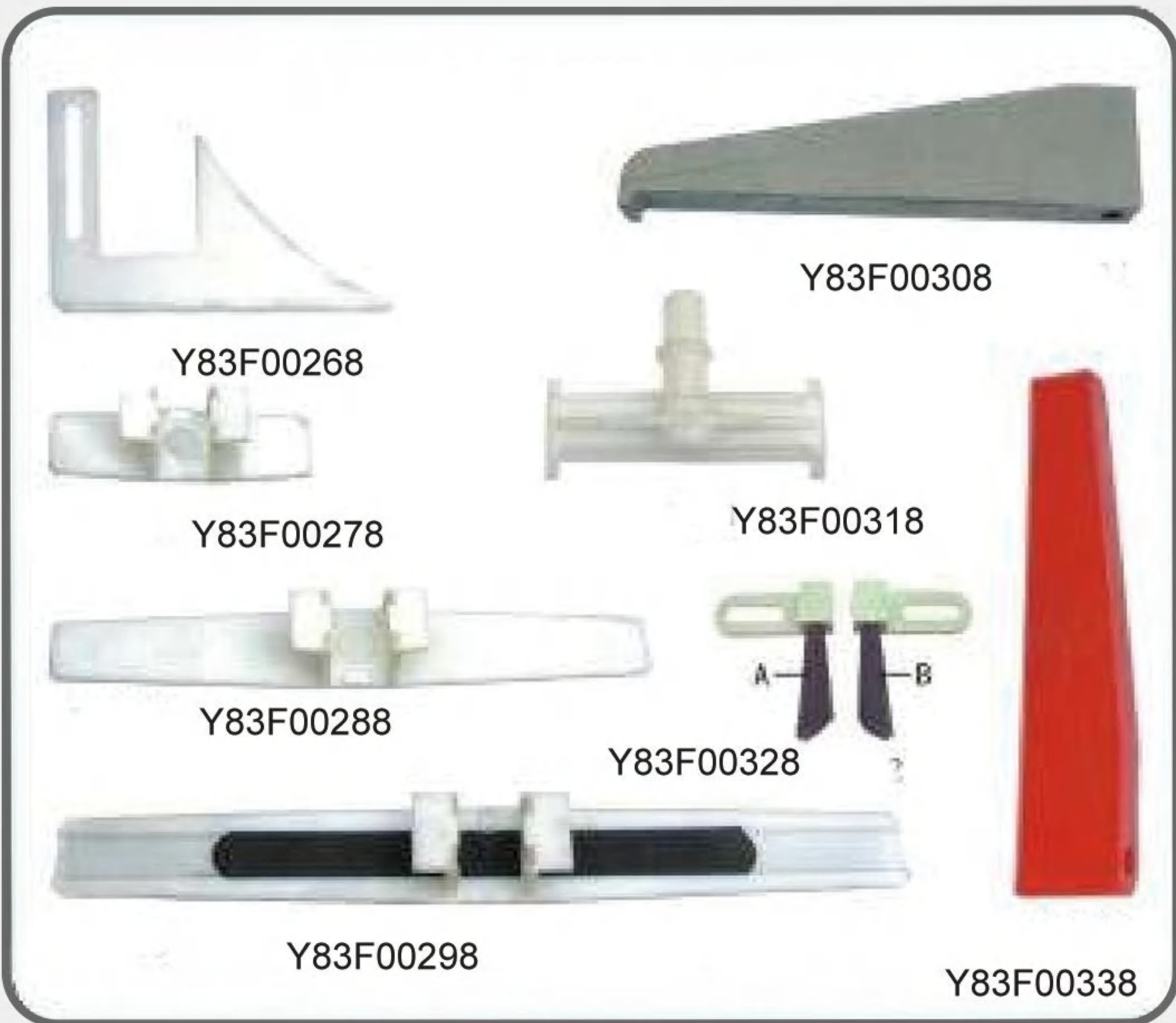
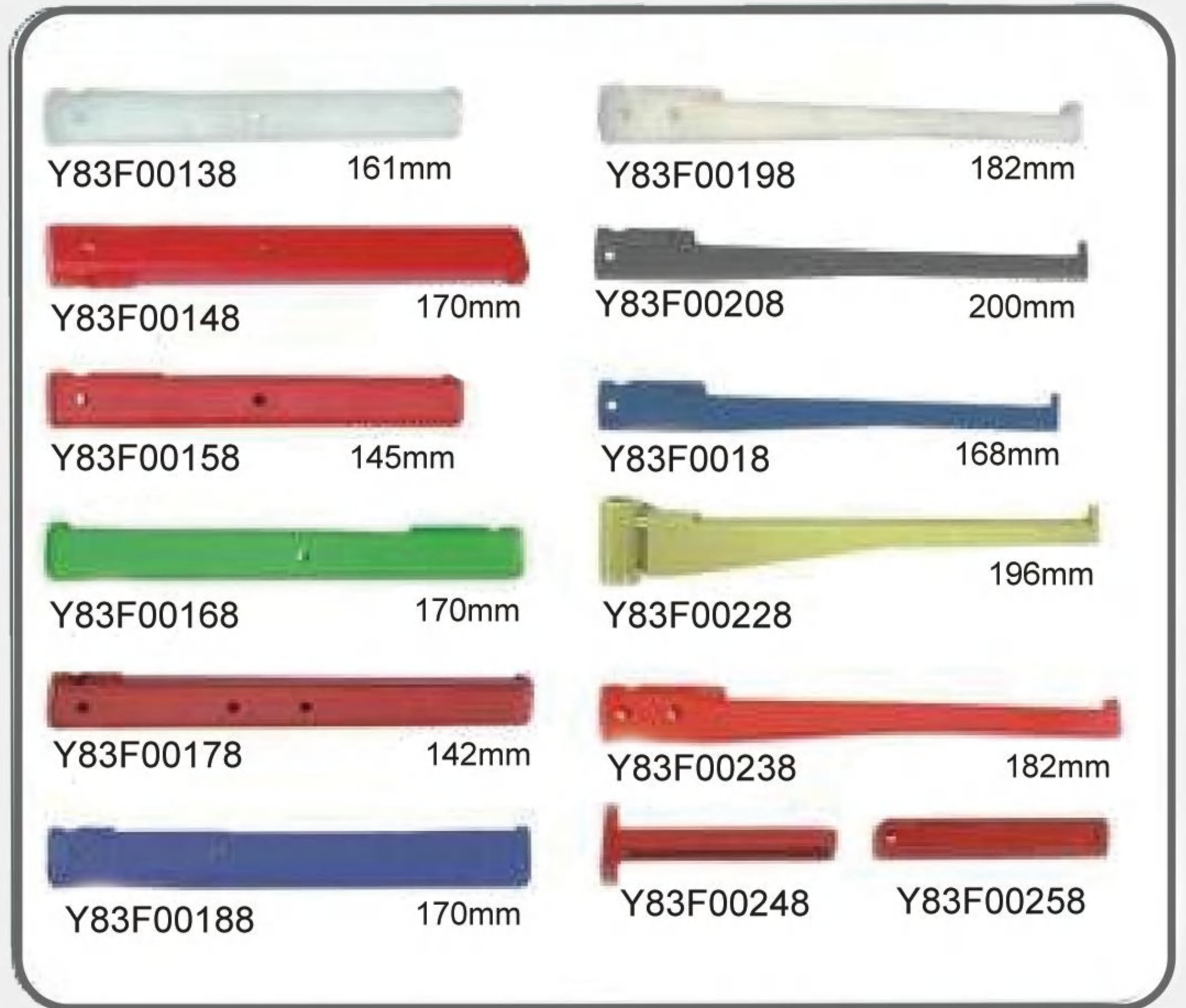
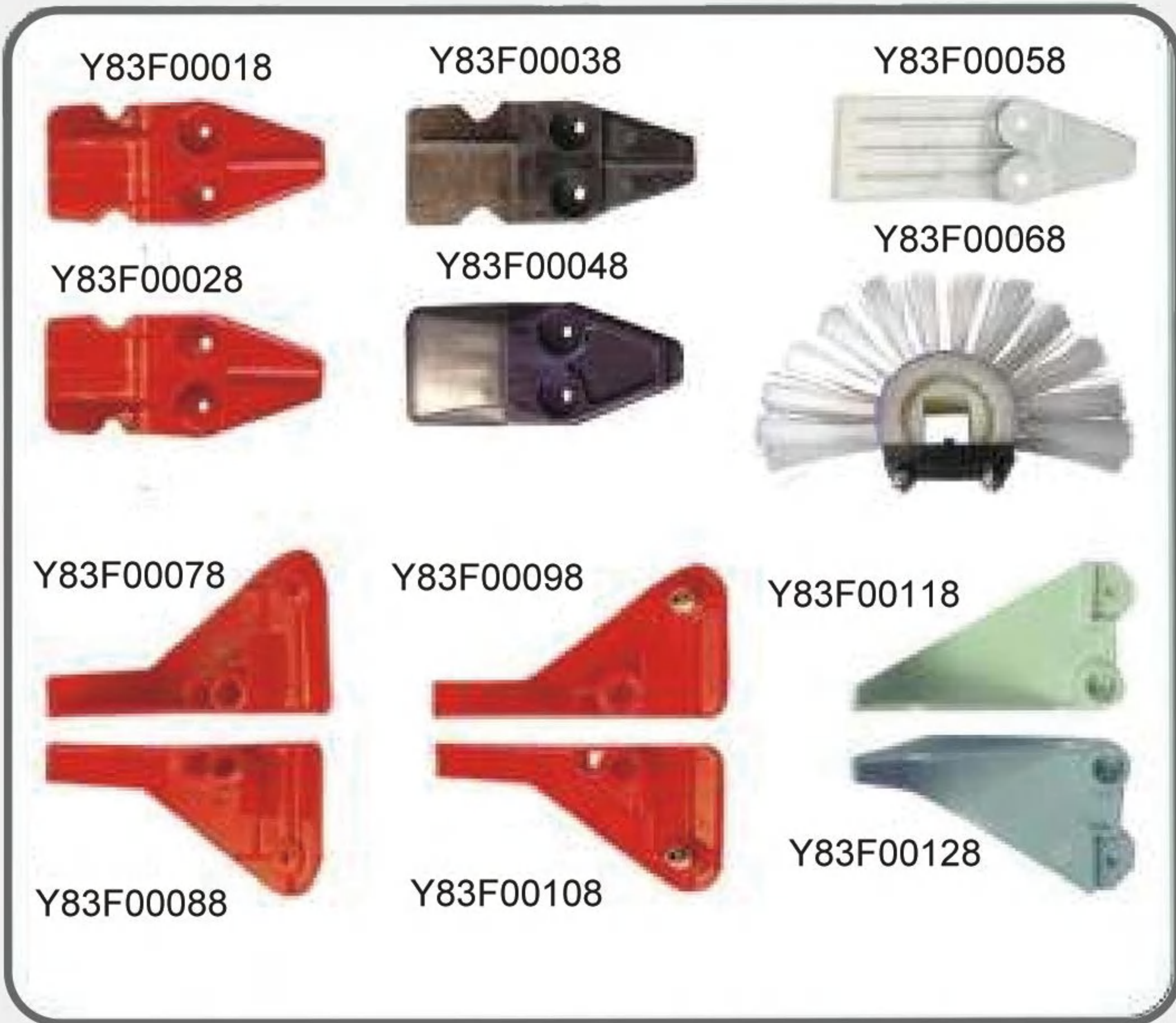



EISI® Stitching Machine Spare Parts



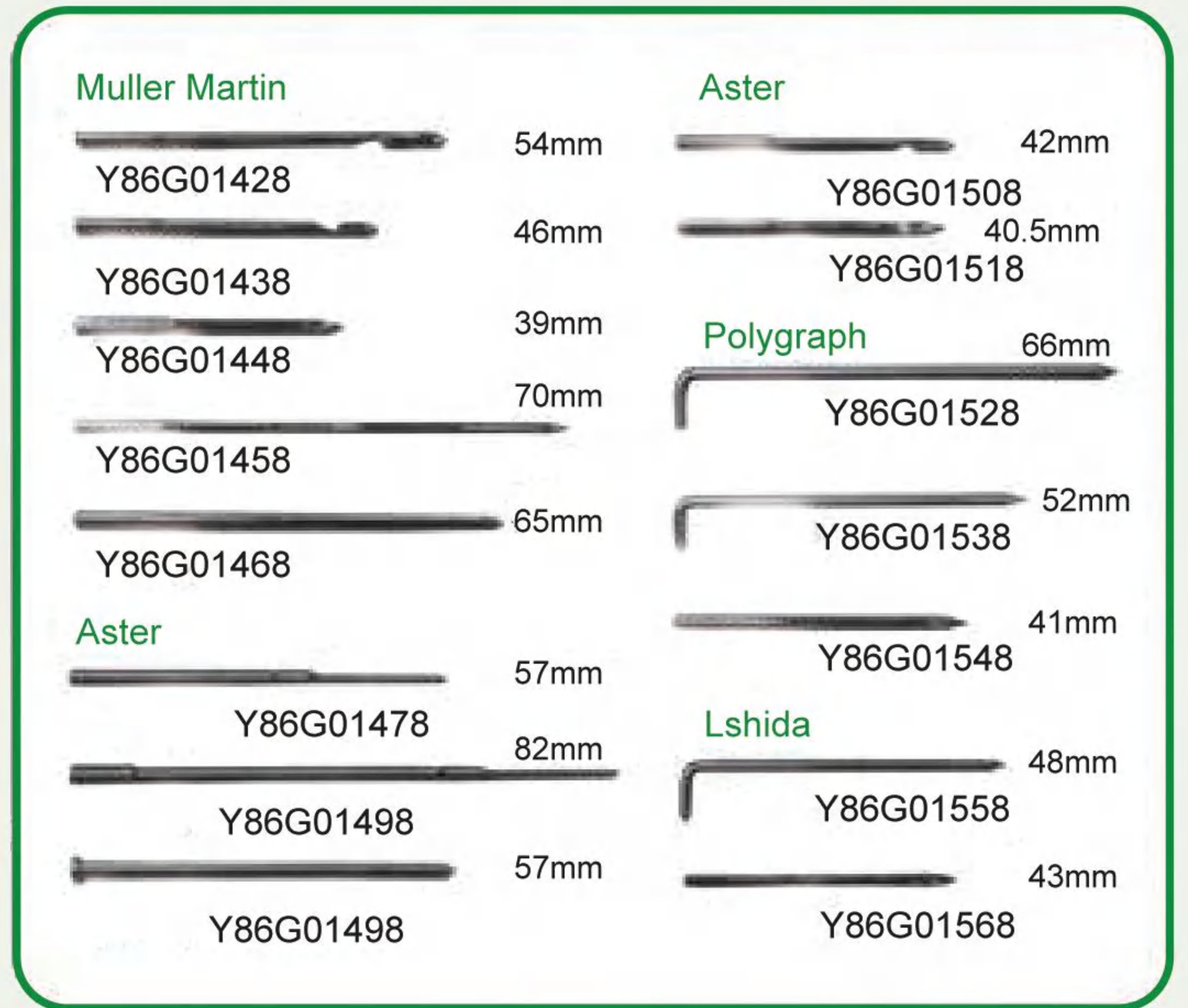

EISI® Cutting Machine Spare Parts





CODE	MODEL	SIZE
Y88H00628	MartiniT-10 630mm	63 teeth
Y88H00638	MartiniT-10 890mm	89 teeth
Y88H00648	MartiniT-10 970mm	97 teeth
Y88H00658	MartiniT-10 1210mm	121 teeth
Y88H00668	MartiniT-10 1350mm	135 teeth
Y88H00678	MartiniT-10 1460mm	146 teeth
Y88H00688	MartiniT time zone	322 teeth
Y88H00698	MartiniT Bone belt3663.1565.4	277 teeth
Y88H00708	MartiniT-10 boneless belt	277 teeth
Y88H00718	MartiniT-10 Boneless belt	277 teeth
Y88H00728	MartiniT-10 white steel ribbon 450H075	90 teeth
Y88H00738	MartiniT-10 white steel ribbon	280 teeth
Y88H00748	MartiniT-10 white steel ribbon 1400H100	280 teeth
Y88H00758	MartiniT-10 time zone600 L100	160 teeth

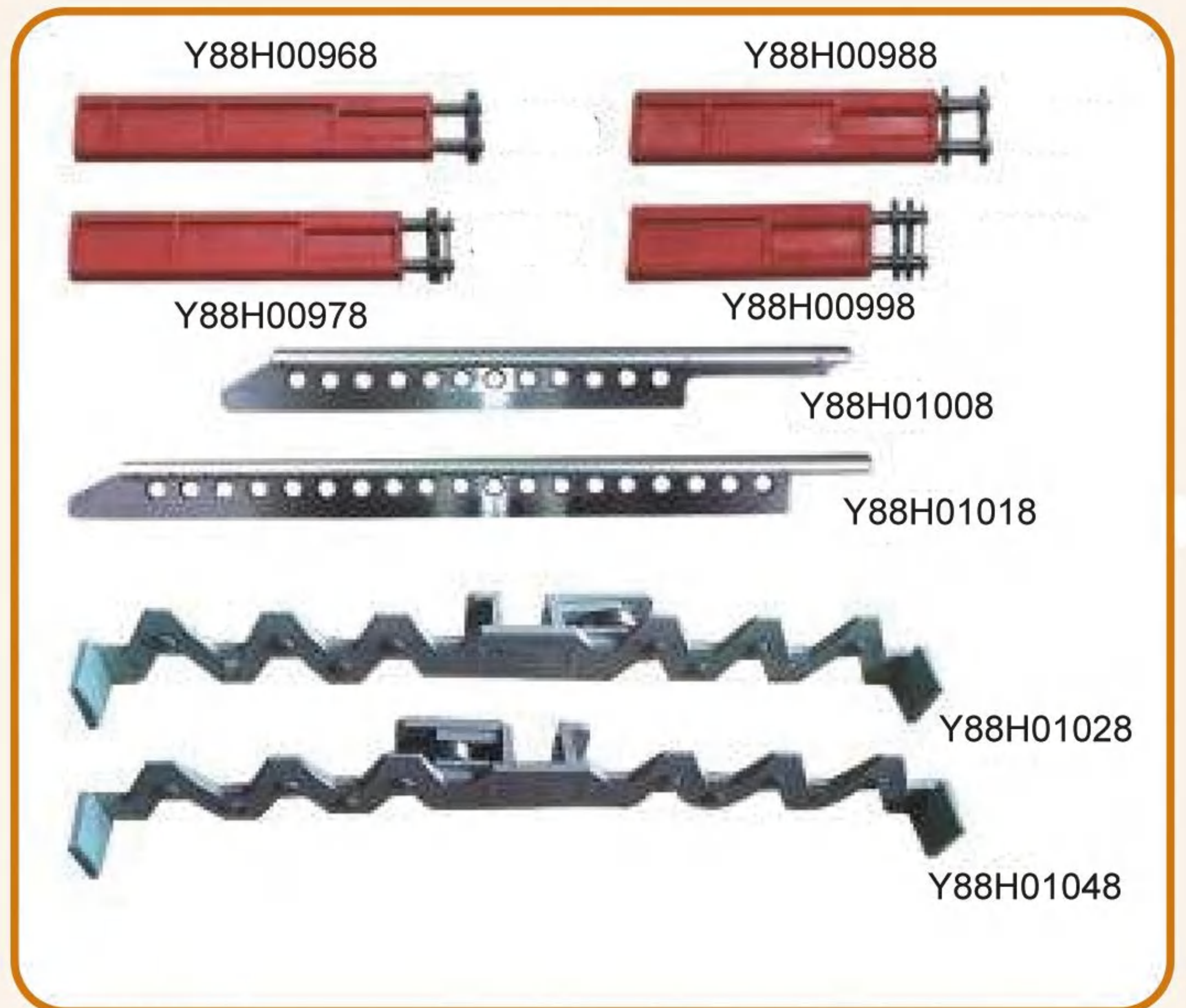

ID=50
 Y8900098
 Y8900108
 ID=60
 Y8900138
 ID=80
 Y8900148
 Y8900118 Y8900128
 Y8900158 RVK3B L=1000mm Bore Φ=60mm
 Y8900168 RVK3B L=1000mm Bore Φ=60mm
 Y8900178 RVP2C L=1000mm Bore Φ=80mm
 Y8900188 RVP2C L=910mm Bore Φ=60mm
 Y8900198 102V L=1000mm Bore Φ=70mm

Y8902198
 Y8902228
 Y8902218
 Y8902238
 Y8902228
 Y891202162
 Y891202142

10X
 Y8901748
 Y8901758
 8X
 Y8901768
 Lamp
 12X
 10X
 Y8901778
 Y8901788
 10X
 5X
 Y8901798
 Lamp

Y89T02398
 Y89T02408
 Y89T02418
 Y89T02428
 Y89T02438
 Y89T02448
 (L)
 Y89T02458
 (M)
 Y89T02468
 (S)

Y8902978
 Y8902978
 Y8902998
 Y8903008 90mm
 Y8903018 75mm
 Y8903028 60mm
 Y8903038 45mm

Y8903088 90mm
 Y8903098 75mm
 Y8903108 60mm
 Y8903118 45mm
 300048

Sheet Separator

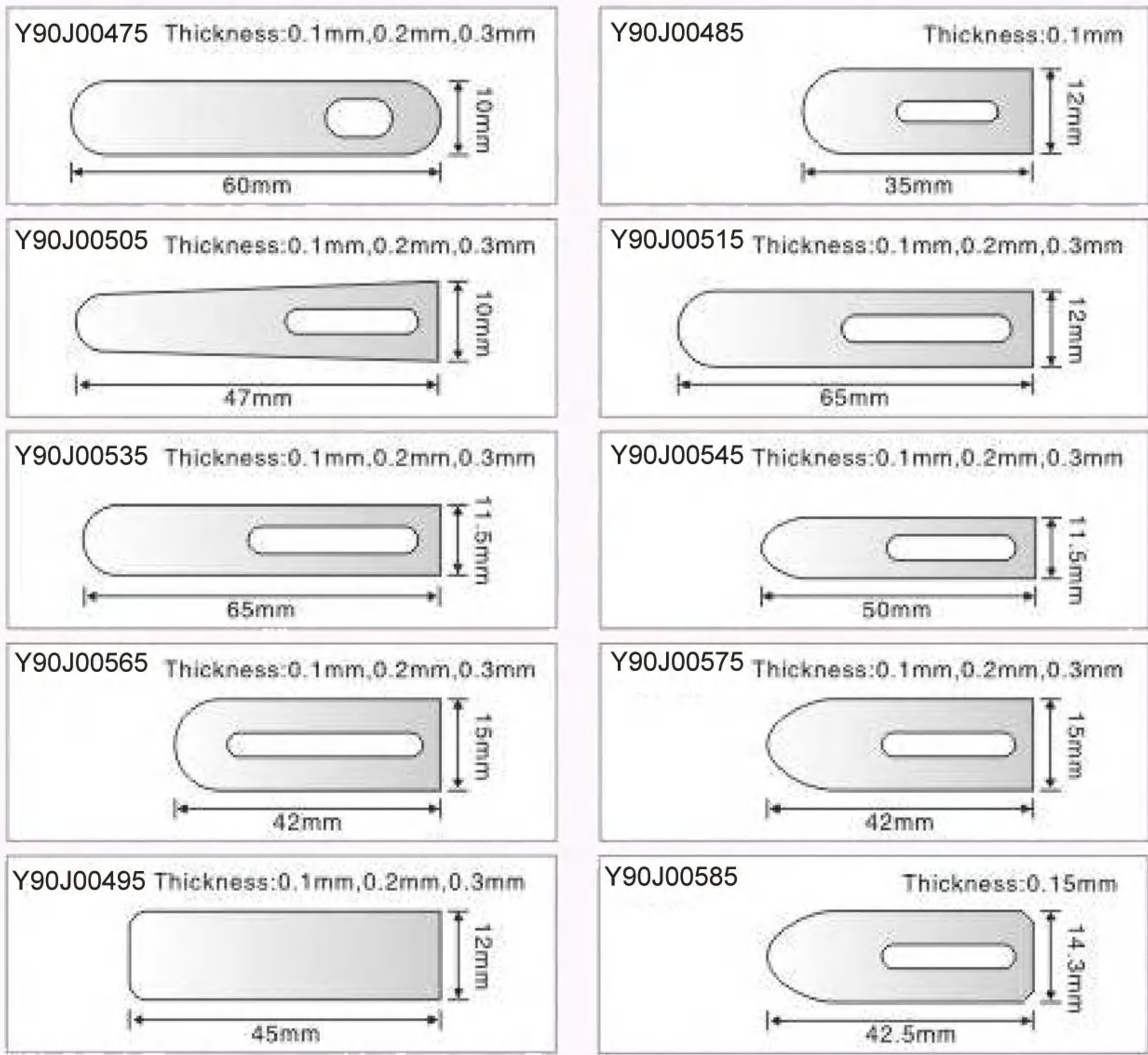

Numbering Machine



Special Regulations
Gothic / Arabic

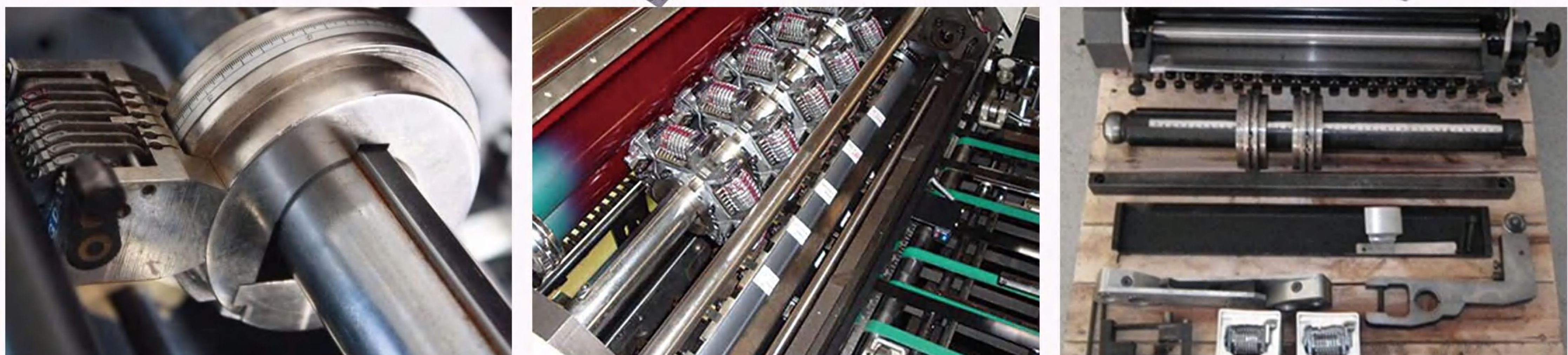

Special specifications can be customized (Font/Size/Number of digits)

N=Number

T=Thickness

ID=Inside Diameter

H=Height

Unit:mm

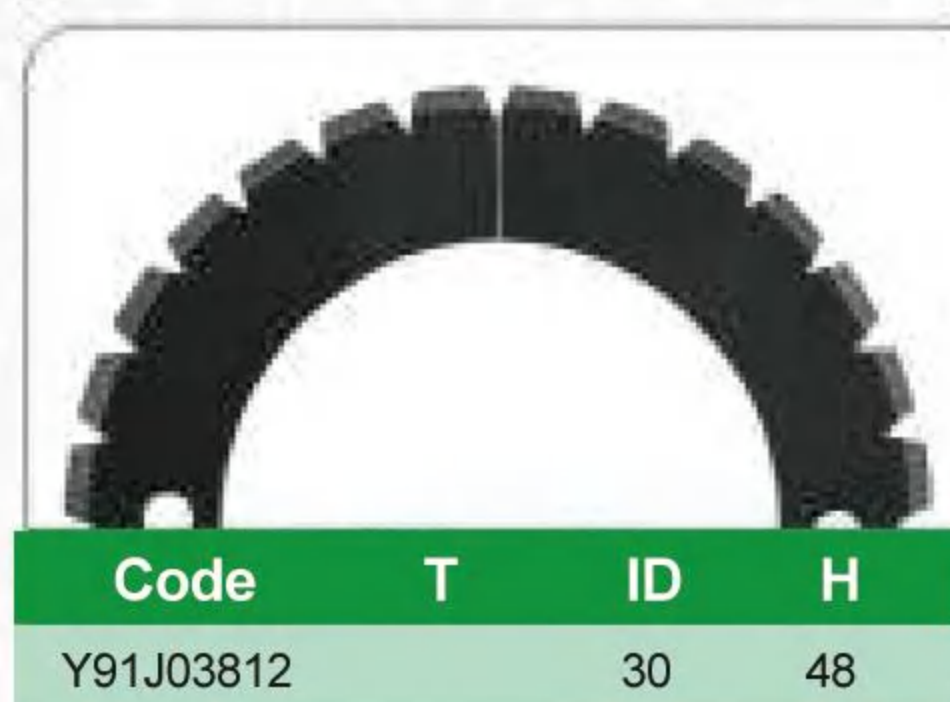
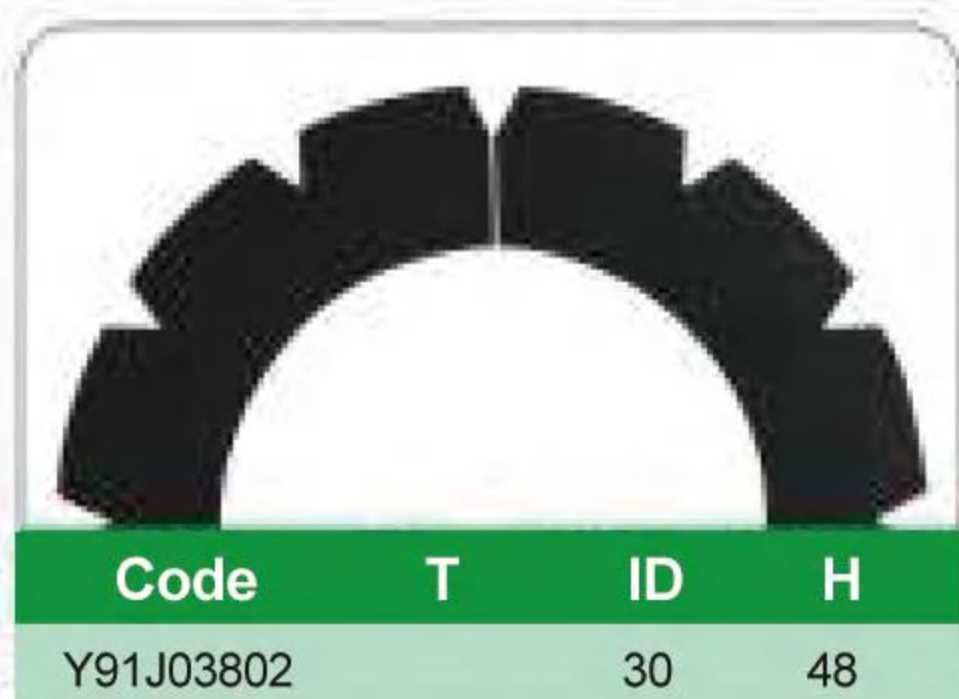
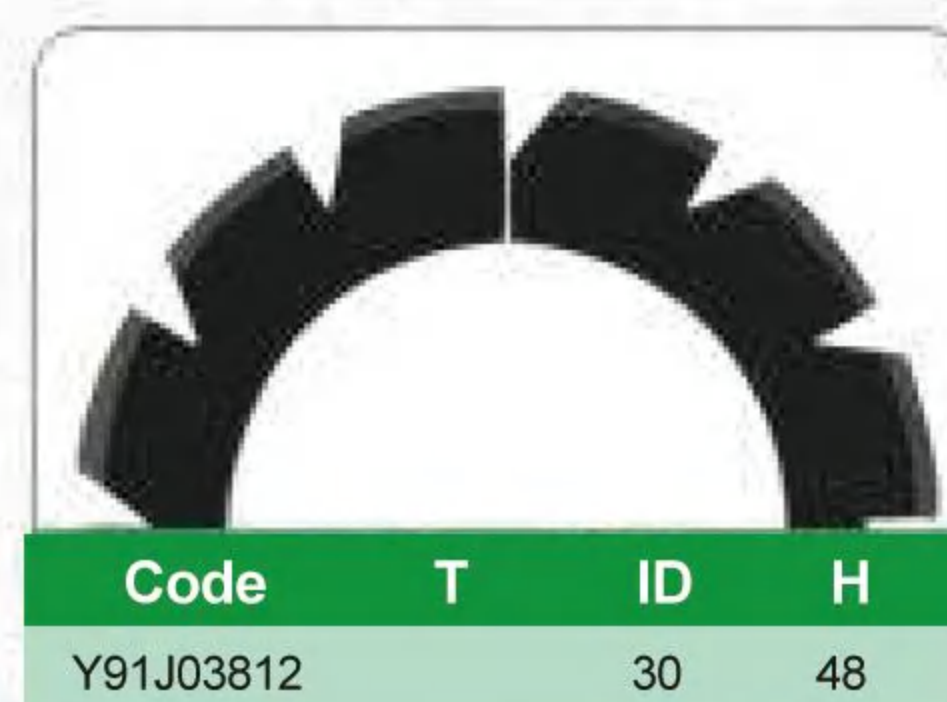
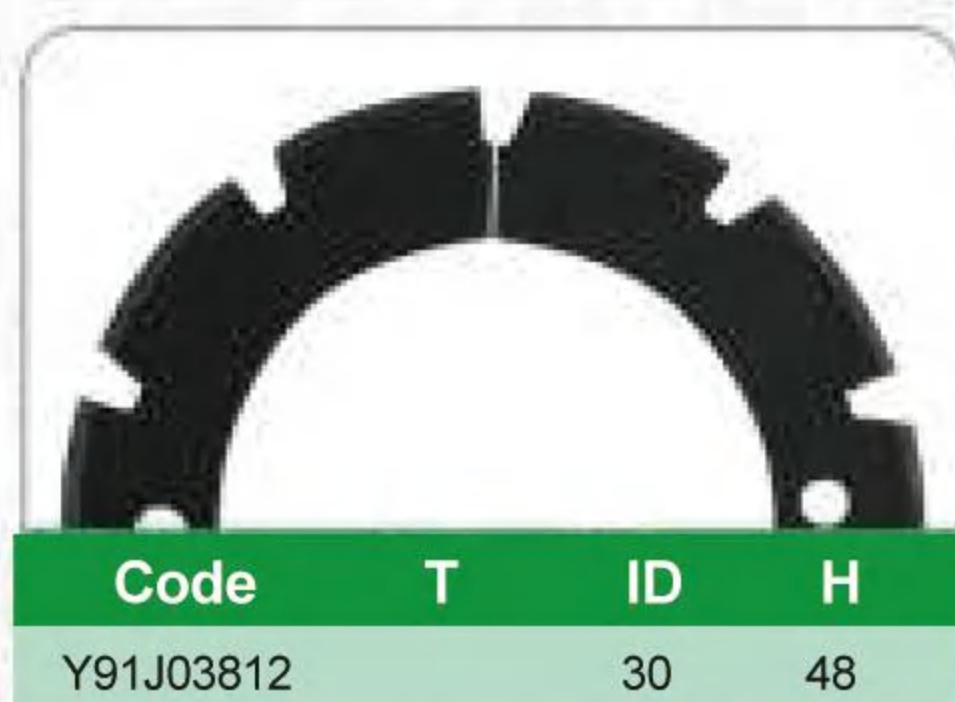
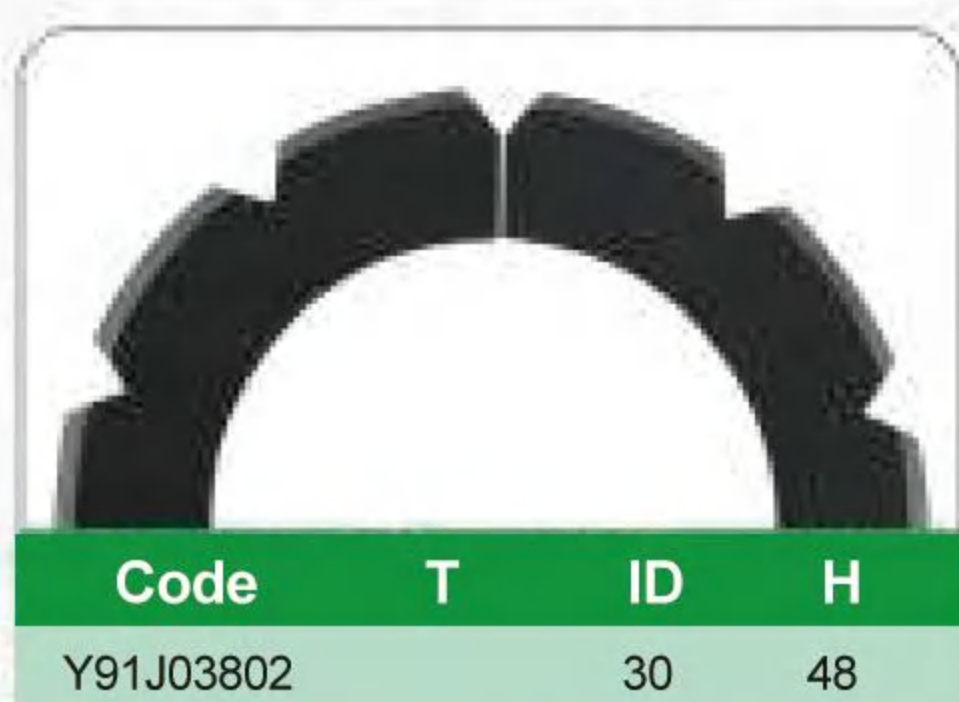
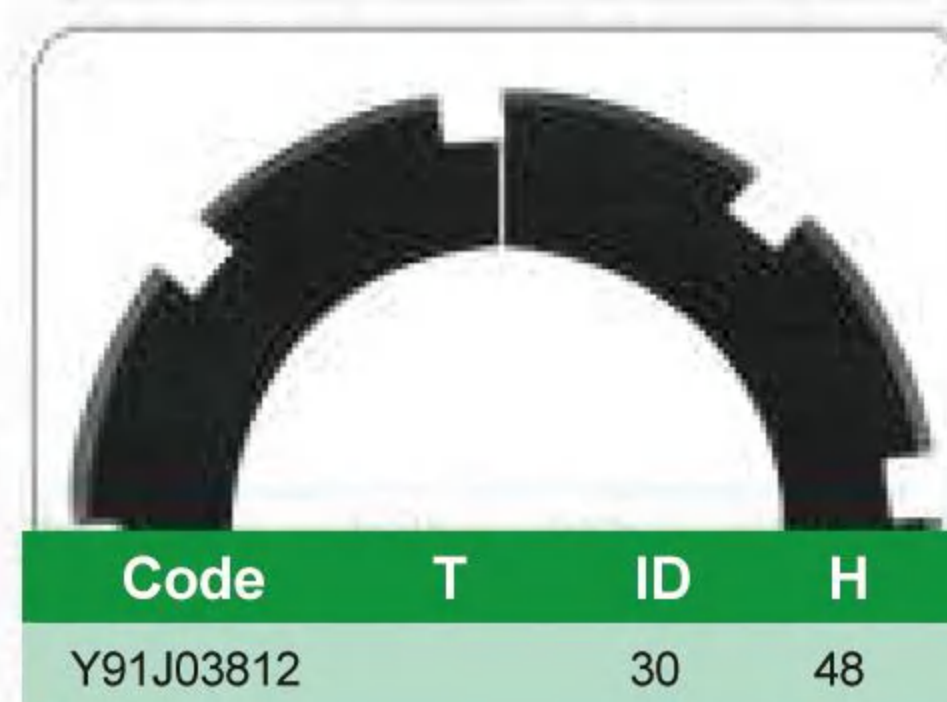
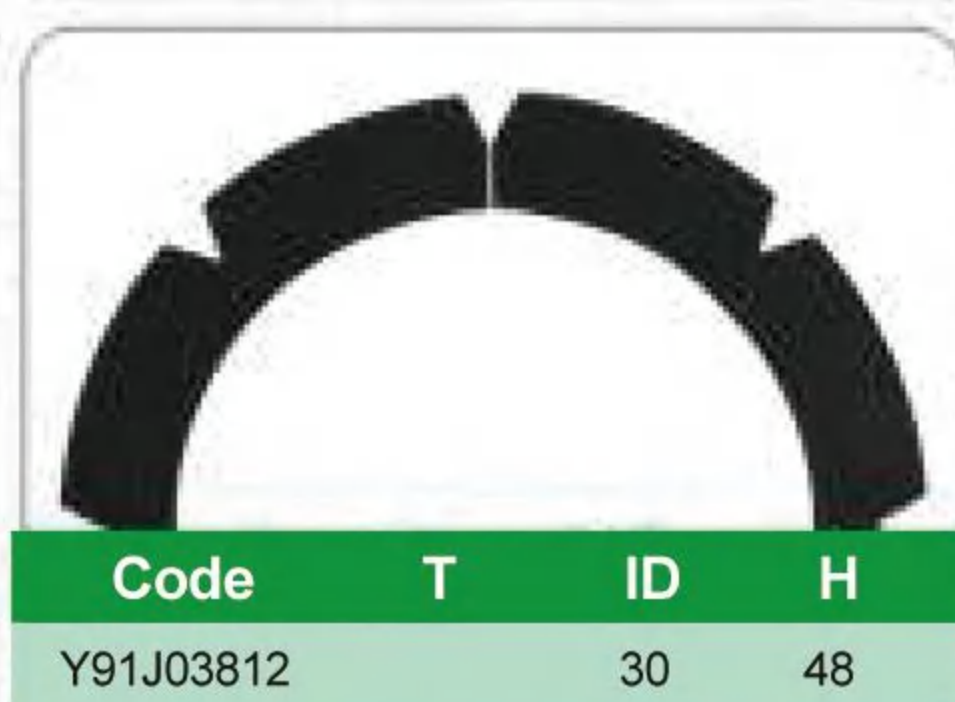
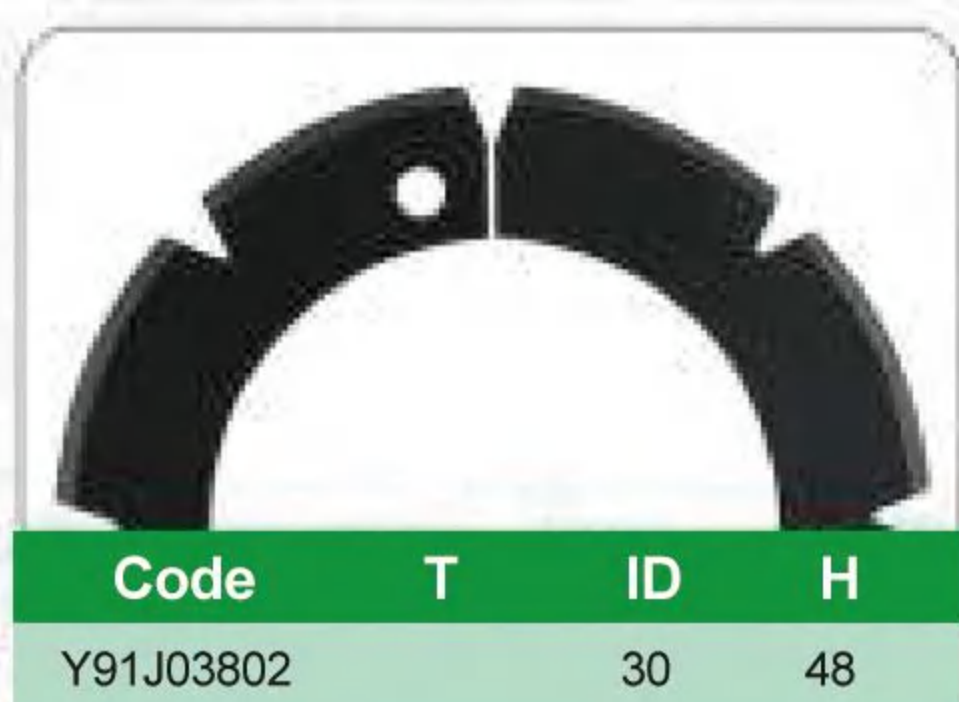
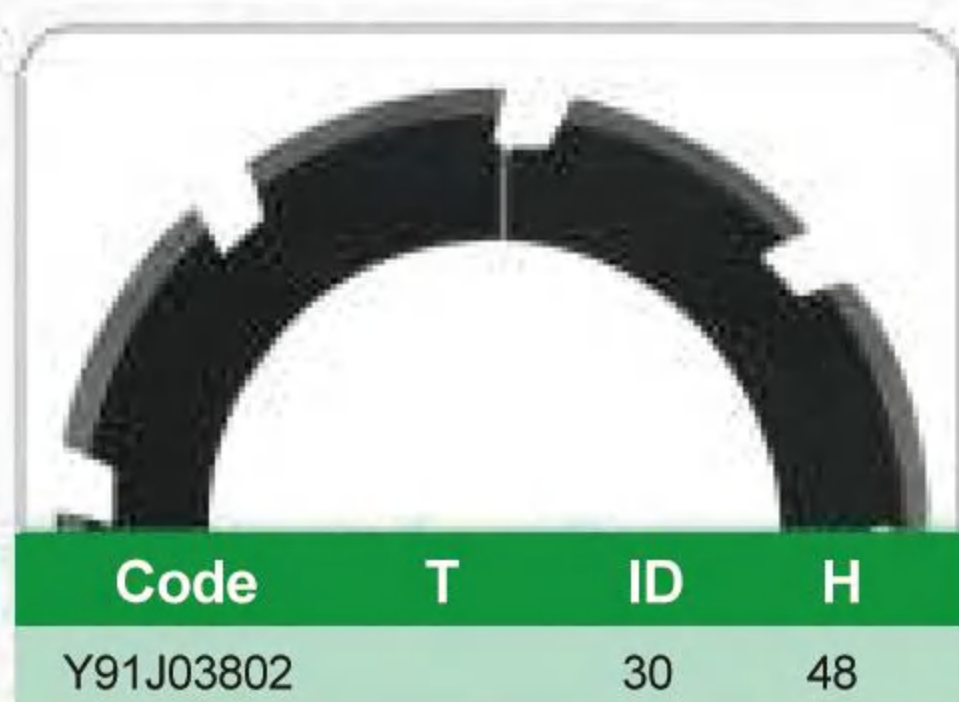
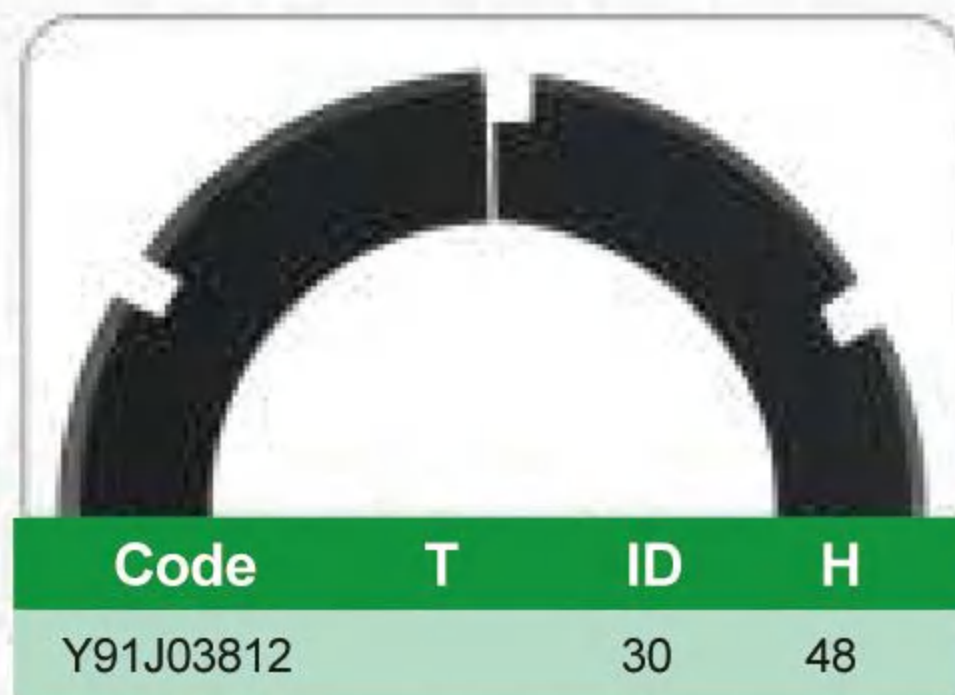
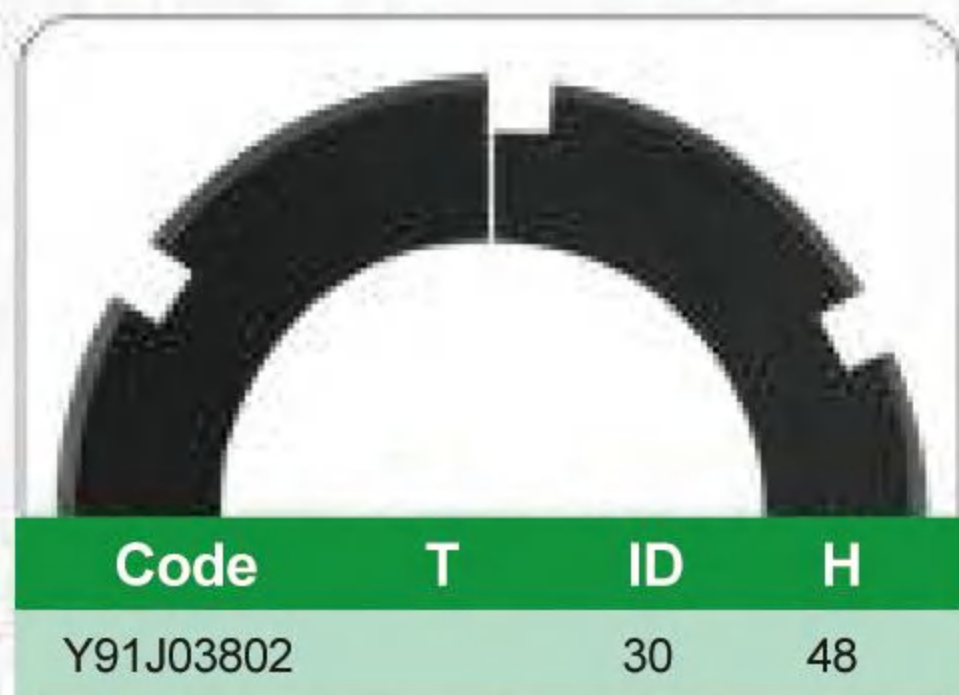
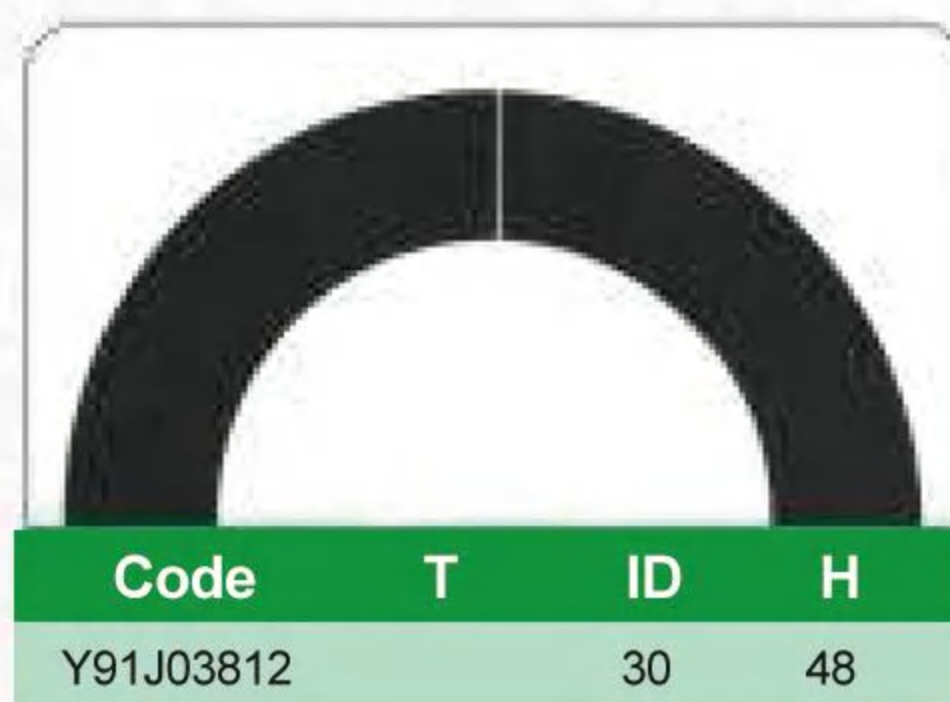
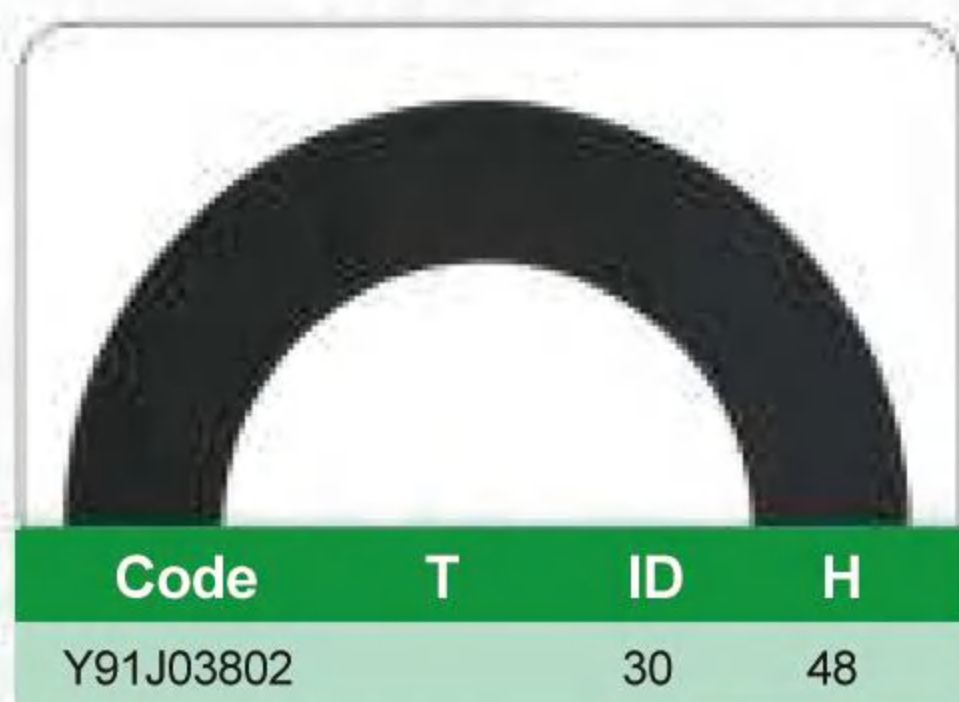

Creasing Matrix

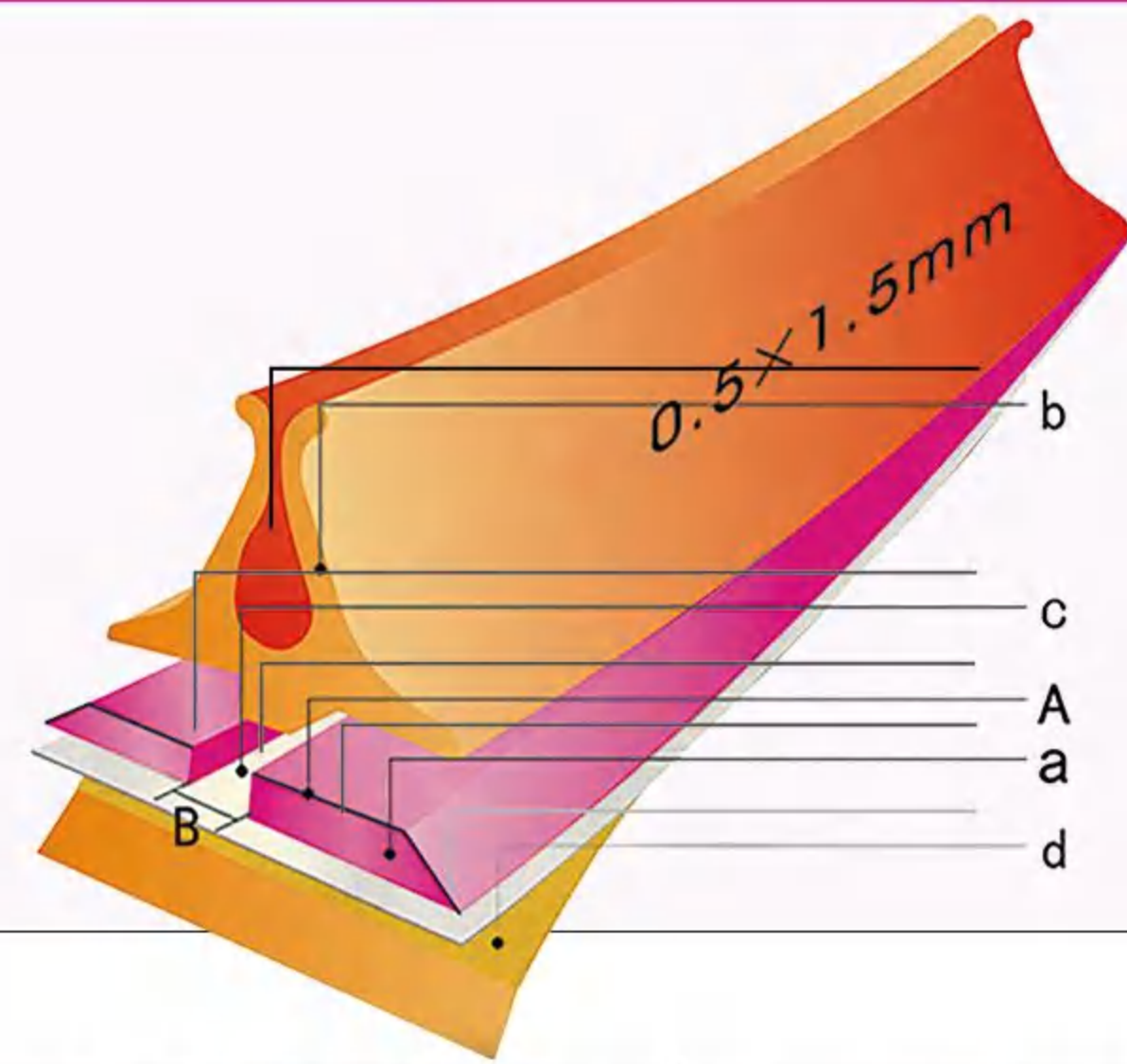
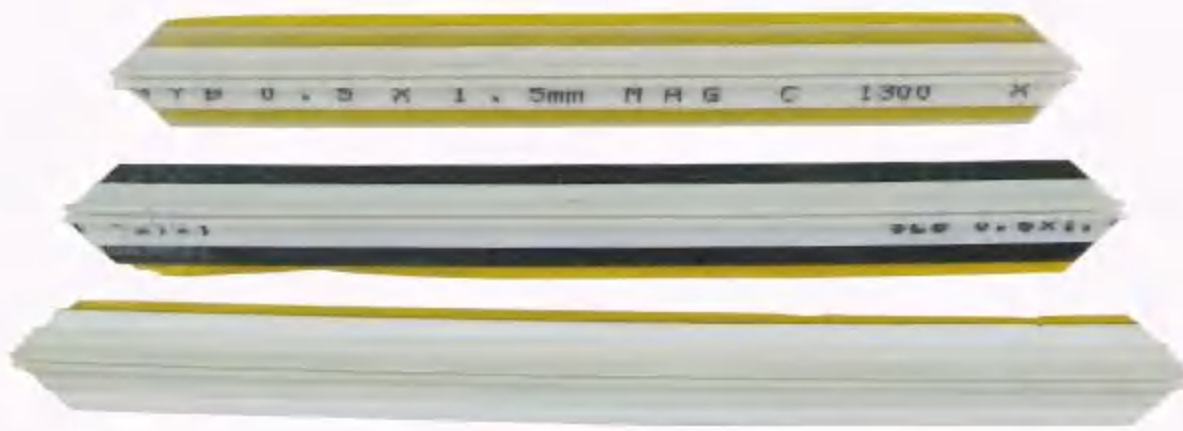

Creasing Matrix Size

0.3*0.8	0.4*0.8	0.5*0.8	0.6*1.5	0.7*1.5	0.8*2.0	1.0*2.7	1.2*3.0	Narrow 0.3*0.8	Narrow 0.5*0.8	Narrow 0.6*1.5	Narrow 0.7*1.6	Double slot 0.4*1.3*1.2	Back pressure line 2Pt0.3*0.6 1.5-1.9
0.3*1.0	0.4*1.0	0.5*1.0	0.6*1.6	0.7*1.7	0.8*2.3	1.0*3.0	1.2*3.5	Narrow 0.3*1.0	Narrow 0.5*1.0	Narrow 0.6*1.6	Narrow 0.7*1.7	Double slot 0.4*1.3*1.9	Back pressure line 2Pt0.3*0.6 2.3-2.7
0.3*1.2	0.4*1.2	0.5*1.2	0.6*1.7	0.7*1.9	0.8*2.5	1.0*3.2	1.2*4.0	Narrow 0.3*1.2	Narrow 0.5*1.2	Narrow 0.6*1.7	Narrow 0.7*2.1	Double slot 0.4*1.3*4.0	Back pressure line 2Pt0.3*0.6 1.9-2.3
0.3*1.3	0.4*1.3	0.5*1.3	0.6*1.9	0.7*2.1	0.8*2.7	1.0*3.5	1.2*4.5	Narrow 0.3*1.3	Narrow 0.5*1.3	Narrow 0.6*1.9	Narrow 0.7*2.3	Double slot 0.5*2.1*1.0	Back pressure line 3Pt0.3*0.6 2.7-3.2
0.3*1.4	0.4*1.4	0.5*1.4	0.6*2.0	0.7*2.3	0.8*3.0	1.0*4.0	1.2*5.0	Narrow 0.3*1.4	Narrow 0.5*1.4	Narrow 0.6*2.1	Narrow 0.7*2.5	Double slot 0.5*2.5*1.0	Back pressure line 3Pt0.3*0.6 2.3-2.7
0.3*1.5	0.4*1.5	0.5*1.5	0.6*2.1	0.7*2.5	0.8*3.2	1.0*4.5	1.2*6.0	Narrow 0.3*1.5	Narrow 0.5*1.5	Narrow 0.6*2.3	Narrow 0.8*2.3	Double slot 0.6*2.7*1.0	Back pressure line 3Pt0.3*0.6 1.9-2.3
0.3*2.1	0.4*1.6	0.5*1.6	0.6*2.3	0.7*2.7	0.8*3.5	1.0*5.0	1.2*7.0	Narrow 0.4*0.8	Narrow 0.5*1.6	Narrow 0.6*2.5	Narrow 0.8*2.5	Double slot 0.6*2.0*1.0	Back pressure line 3Pt0.3*0.8 1.9-2.3
	0.4*1.9	0.5*1.9	0.6*2.5	0.7*3.0	0.8*4.0	1.0*6.0	1.4*5.0	Narrow 0.4*1.0	Narrow 0.5*1.7	Narrow 0.6*2.7	Narrow 0.8*2.7	Double slot 0.6*2.3*1.0	Back pressure line 3Pt0.3*0.8 2.3-2.7
	0.4*2.0	0.5*2.1	0.6*2.7	0.7*3.2	0.8*4.5	1.0*7.0	1.4*6.0	Narrow 0.4*1.2	Narrow 0.5*1.9	Narrow 0.6*3.0		Double slot 0.6*1.9*1.0	Back pressure line 3Pt0.3*0.8 2.7-3.2
	0.4*2.3	0.5*2.3	0.6*3.0	0.7*3.5	0.8*5.0		1.4*7.0	Narrow 0.4*1.3	Narrow 0.5*2.1	Narrow 0.6*4.0		Double slot 0.6*2.5*1.0	Back pressure line 3Pt0.3*1.0 1.9-2.3
	0.4*2.5	0.5*2.5	0.6*3.2		0.8*6.0			Narrow 0.4*1.4	Narrow 0.5*2.5			Double slot 0.6*2.3*2.7	Back pressure line 4Pt0.3*0.9 2.7-3.2
	0.4*2.7	0.5*3.0	0.6*3.5					Narrow 0.4*1.5				Double slot 0.7*2.5*1.0	Back pressure line 4Pt0.3*0.9 3.5-4.0
	0.4*3.0	0.5*3.2	0.6*4.0					Narrow 0.4*1.6				Double slot 0.8*2.3*1.0	
		0.5*5.0	0.6*5.0					Narrow 0.4*1.7				Double slot 0.8*2.5*1.0	
			0.6*6.0					Narrow 0.4*2.1				Double slot 0.8*3.0*1.0	
												Double slot 0.8*3.0*2.0	



Perfect Perf

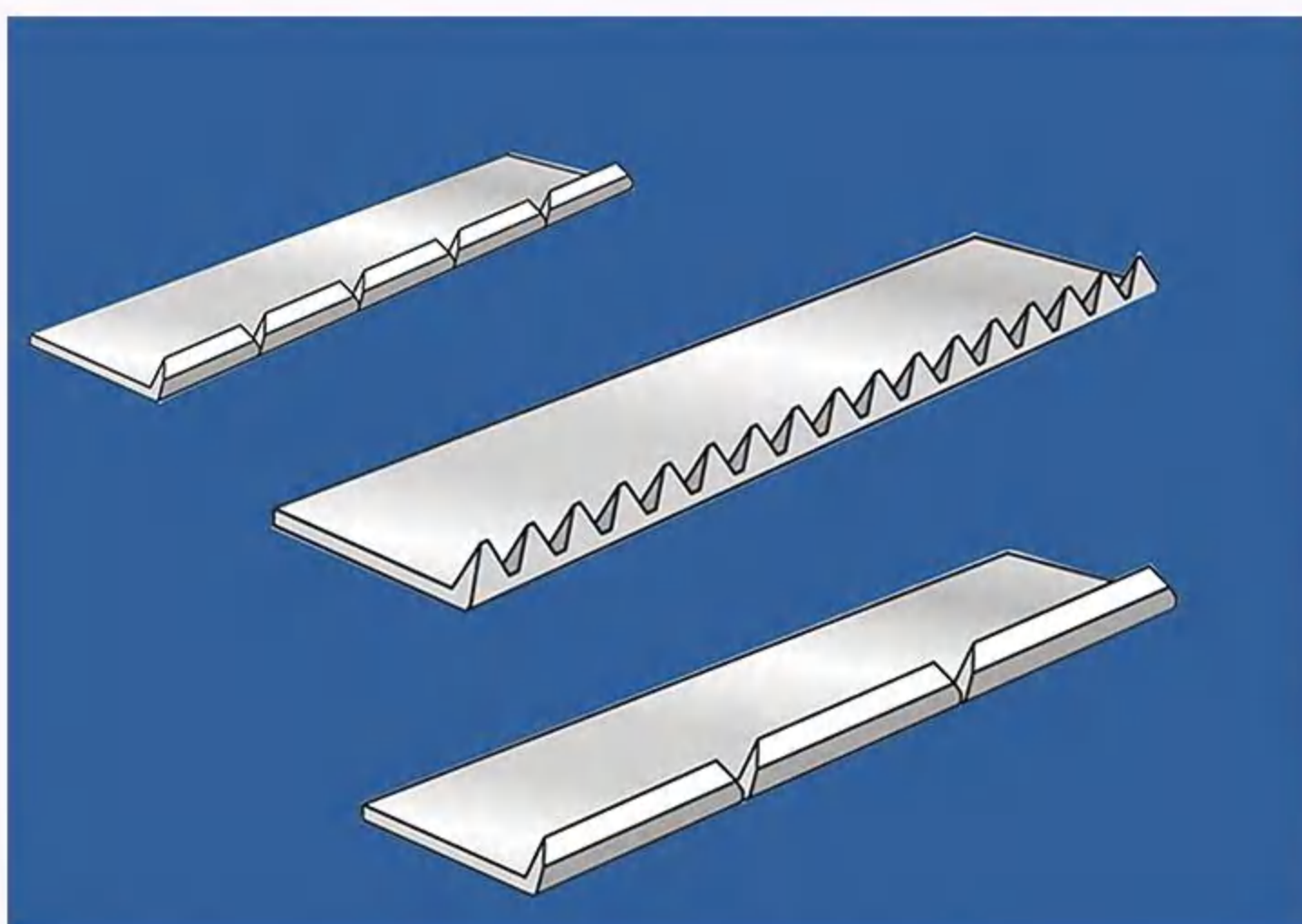
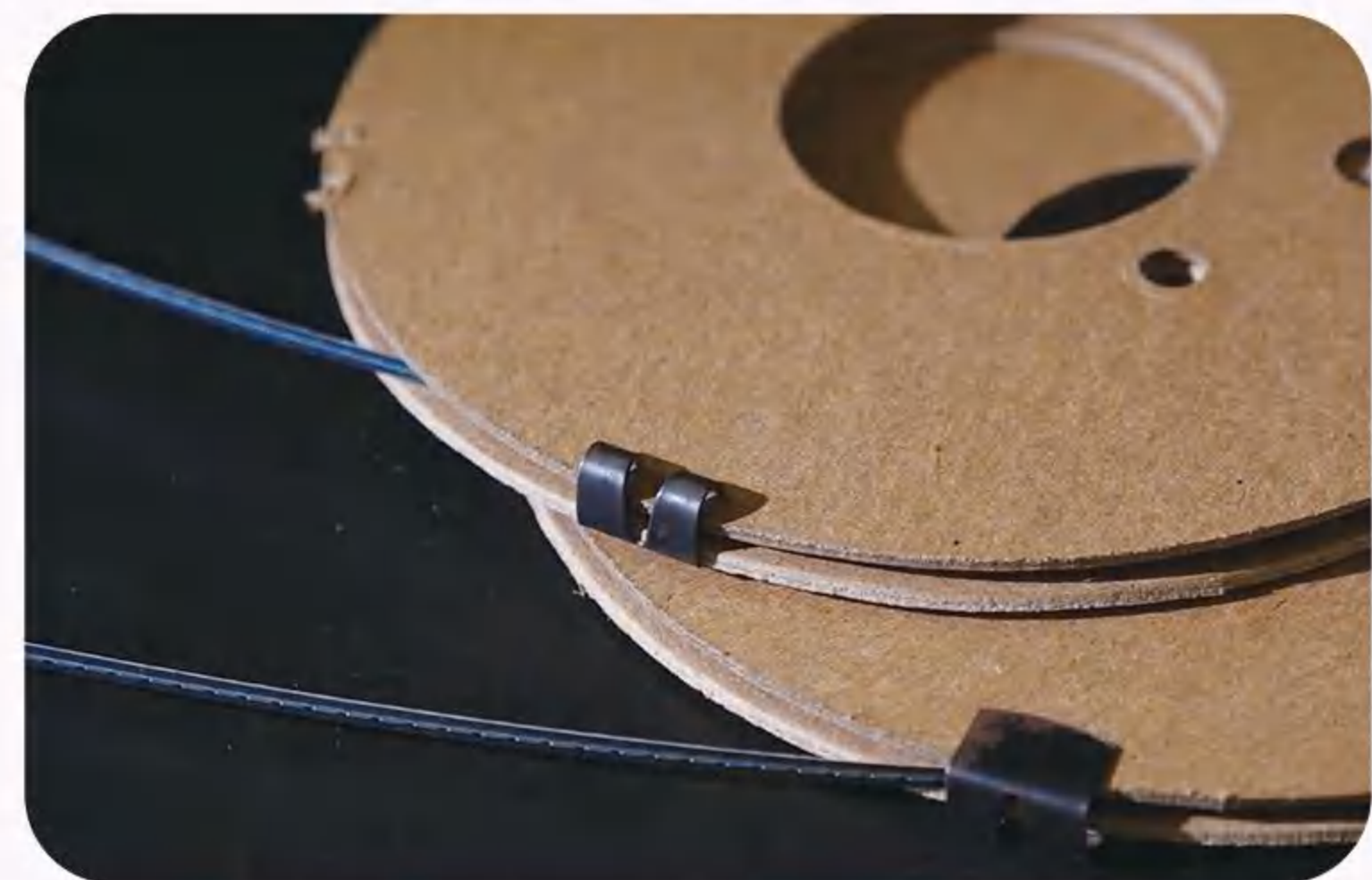

PERF	16 TPI	12 TPI	8 TPI	6 TPI
Description	Item #	Item #	Item #	Item #
Card 10 ft (3 m)	T-504	T-506	T-508	T-510
Card 20 ft (6 m)	T-505	T-507	T-509	T-511
Paper 10 ft (3 m)	T-604	T-606	T-608	T-610
Paper 20 ft (6 m)	T-605	T-607	T-609	T-611

MICRO-PERF	30 TPI	40 TPI	50 TPI	SNAP	4 TPI	3 TPI
Description	Item #	Item #	Item #	Description	Item #	Item #
Paper 10 ft (3 m)	T-619	T-620	T-621	Card 10 ft (3 m)	T-512	T-514
Paper 20 ft (6 m)	T-616	T-617	T-618	Card 20 ft (6 m)	T-513	T-515
				Paper 10 ft (3 m)	T-612	T-614
				Paper 20 ft (6 m)	T-613	T-615

SLIT	SCORE
Description	Description
Card 10 ft (3 m)	Card 10 ft (3 m)
Card 20 ft (6 m)	Card 20 ft (6 m)
Paper 10 ft (3 m)	Card (round top) 20 ft (6 m)
Paper 20 ft (6 m)	Paper 10 ft (3 m)
	Paper 20 ft (6 m)
Item #	Item #
T-502	T-500
T-503	T-501
T-602	T-501-R
T-603	T-600
	T-601

Auto Wash Brush Roller

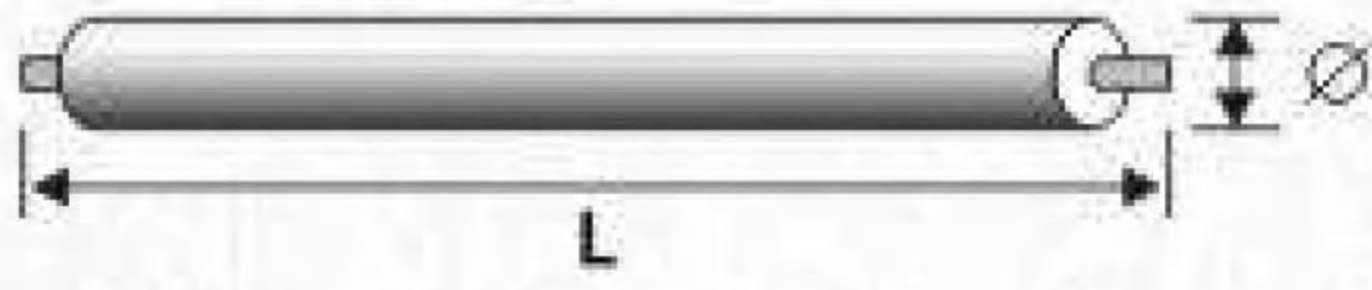

	L
820mm 32.28"	
Ø	
82mm 3.23"	
Code	
Y93D05911	

SM 72/74(连钢芯)

	L
1120mm 77.09"	
Ø	
82.8mm 3.26"	
Code	
Y93J05922	

SM 102(连钢芯)

	L
1113mm 43.82"	
Ø	
83.5mm 3.29"	
Code	
Y93J05933	

SM 102CD(连钢芯)

	L
1138mm 44.80"	
Ø	
83mm 3.27"	
Code	
Y93J05944	

SM 102CD(连钢芯)

	L
830mm 32.68"	
Ø	
70mm 2.76"	
Code	
Y93J05955	

R300(连钢芯)

	L
845mm 32.09"	
Ø	
60mm 2.36"	
Code	
Y93J05966	

R300(连钢芯)

	L
1064mm 41.89"	
Ø	
70mm 2.76"	
Code	
Y93D05977	

R700(连钢芯)

	L
1500mm 59.06"	
Ø	
90mm 3.54"	
Code	
Y93D05988	

R900(连钢芯)

毛刷 Auto Wash Brushes

	Y93J05999
L:660mm 25.98"	
W:30mm 1.18"	
H:37mm 1.46"	

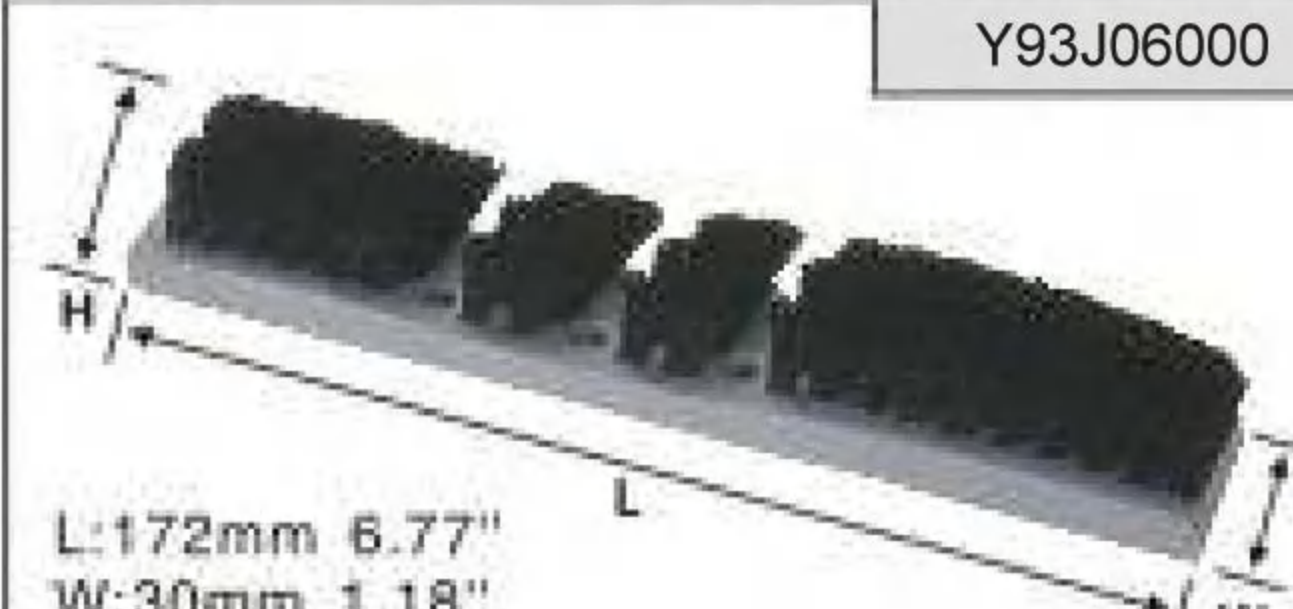
	Y93J06000
L:172mm 6.77"	
W:30mm 1.18"	
H:21mm 0.83"	

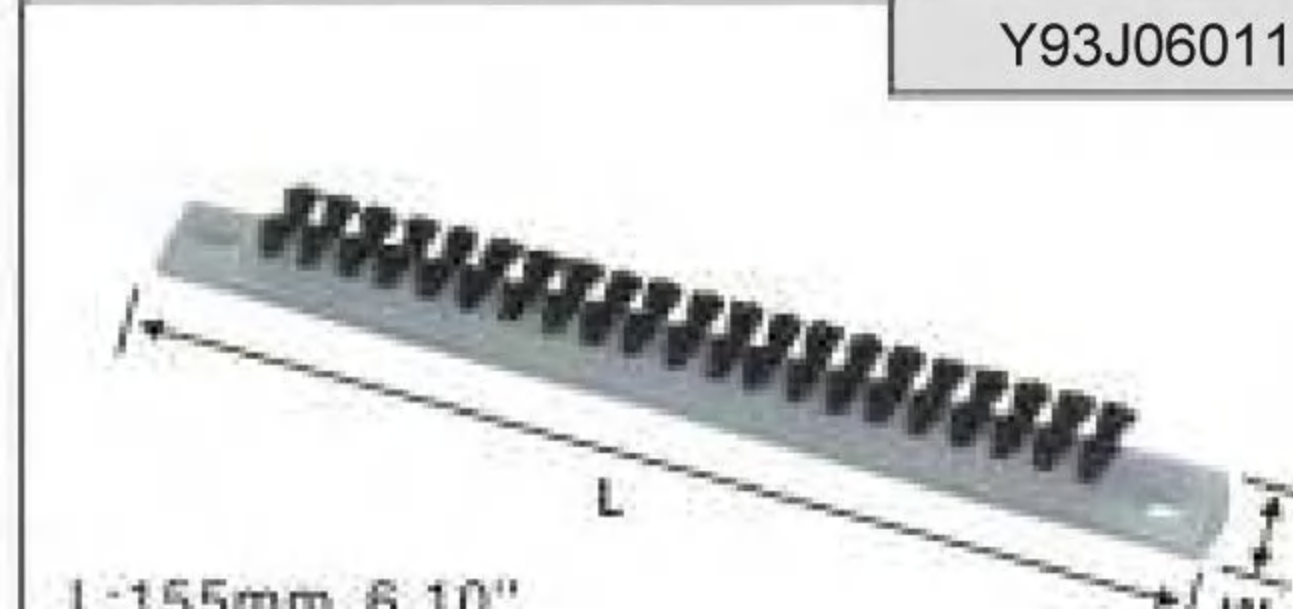
	Y93J06011
L:155mm 6.10"	
W:12mm 0.47"	

	Y93J06022
L:660mm 25.98"	
W:30mm 1.18"	
H:37mm 1.46"	

	Y93J06033
L:245mm 9.65"	
W:12mm 0.47"	
H:19mm 0.75"	

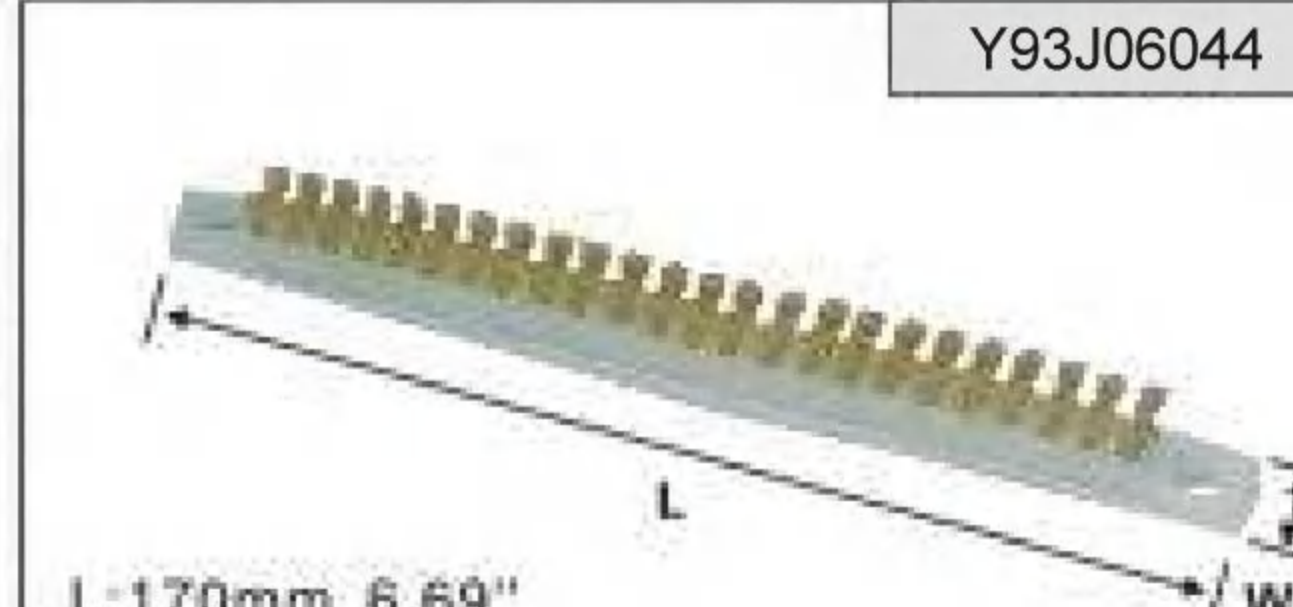
	Y93J06044
L:170mm 6.69"	
W:12mm 0.47"	

	Y93J06055
L:133mm 5.24"	
W:20mm 0.79"	
H:38mm 1.50"	

	Y93J06066
L:210mm 8.27"	
W:12mm 0.47"	
H:19mm 0.75"	

	Y93J06077
L:172mm 6.77"	
W:15mm 0.59"	
H:20mm 0.79"	

Dampening Covers



Code	Contacts	Loom diameter	Roller diameter (mm)
Y94J06081	44#		25-30
Y94J06092	52#	51	35-40
Y94J06103	64#	70	40-45
Y94J06114	76#	76	45-50
Y94J06125	84#	82	50-55
Y94J06136	96#	89	57-60

Code	Contacts	Loom diameter	Roller diameter (mm)
Y94J06147	108#	89	61-63
Y94J06158	116#	95	68-70
Y94J06169	124#	102	74-77
Y94J061710	132#	108	85-88
Y94J061811	140#	114	90-93
Y94J061912	148#	120	96-100

Ink Duct Foil



Code	Machine Model	Width(mm)	Width(Inch)	Length(mm)	Length(Inch)
Y94J062013	QK46	200	7.87"	358	14.09"
Y94J062114	G.T.O52	200	7.87"	547	21.54"
Y94J062215	S.M52	200	7.87"	548	21.57"
Y94J062316	S.M52CD	196	7.72"	548	21.57"
Y94J062417	M.O.65	200	7.87"	675	26.57"
Y94J062518	M.O.65-CD"NEW"	196	7.72"	675	26.57"
Y94J062619	S.M72/74	232	9.13"	775	30.51"
Y94J062720	S.M74CD"NEW"	228	8.98"	775	30.51"
Y94J062821	S.M102	232	9.13"	1067	42.01"
Y94J062922	S.M102CD"NEW"	228	8.98"	1067	42.01"
Y94J063023	SORD/SO	232	9.13"	935	36.81"
Y94J063124	""WEB-8	260	10.24"	548	21.57"
Y94J063225	""WEB-12-MC 110-HARRIS M1000	260	10.24"	740	29.13"
Y94J063326	""WEB-MC 130-HARRIS M130	260	10.24"	994	39.13"
Y94J063427	""WEB-16/HARRIS 600	260	10.24"	1002	39.45"
Y94J063528	""WEB-16/M600 NTC-HARRIS M600	260	10.24"	1002	39.45"

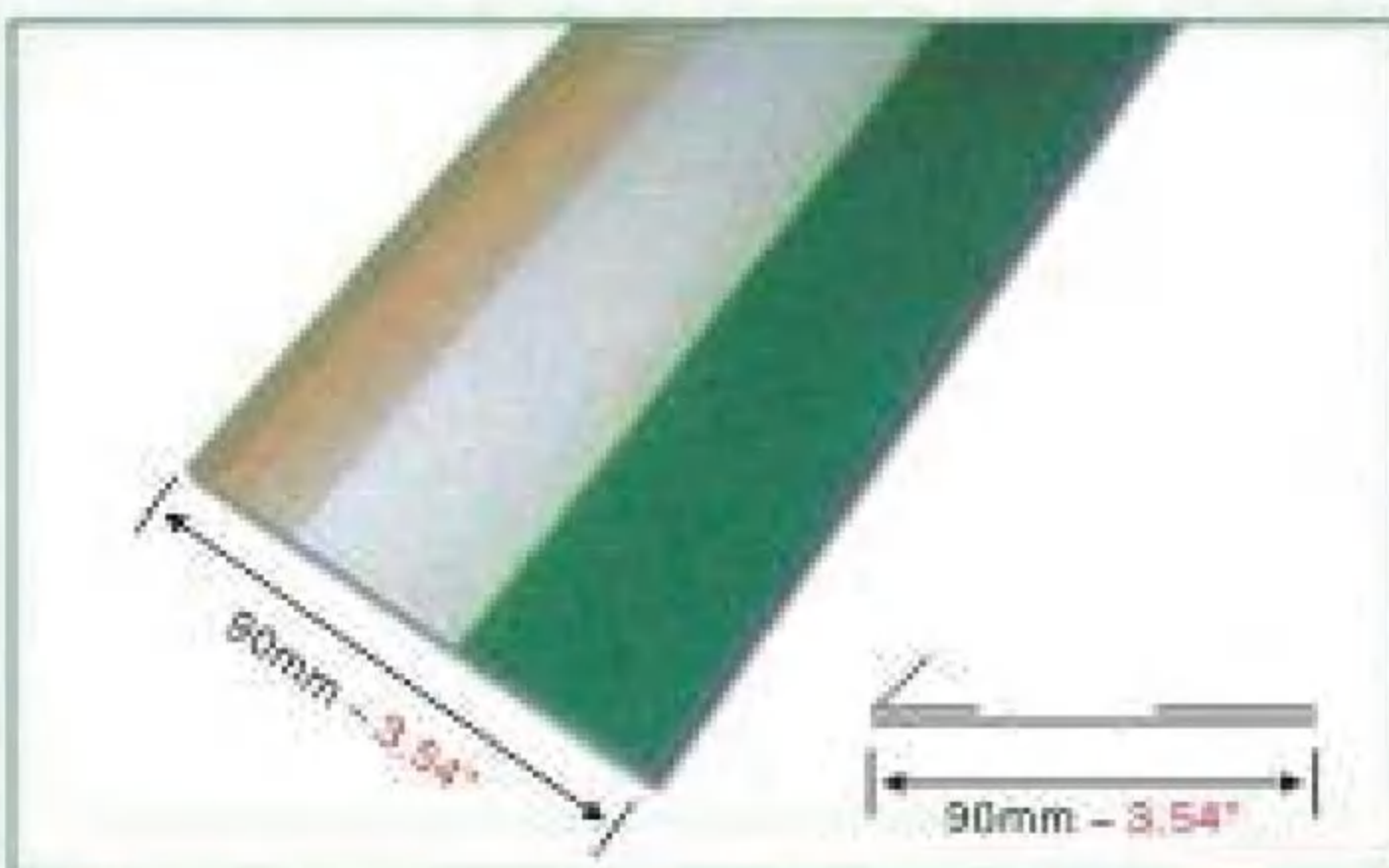

Code	Mode	mm	Inch
Y94J063629	S.M52/52"CD"	550	21.65"
Y94J063730	S.M74/74CD"	777	30.59"
Y94J063831	S.M102/102"CD"	1070	42.13"

Underpacking Film



Code	Thickness	Code	Thickness	Size	Package
Y95J06393	0.1mm	Y95J06453	0.25mm	①1030*760mm ②1450*1150mm	1300mm *50m/rol l
Y95J06403	0.12mm	Y95J06463	0.30mm		
Y95J06413	0.14mm	Y95J06474	0.35mm		
Y95J06423	0.16mm	Y95J06484	0.40mm		
Y95J06433	0.20mm	Y95J06494	0.45mm		
Y95J06443	0.23mm	Y95J06504	0.50mm		

Super Blue



S.NO	PACKEN IN BOX	PRESS SIZE		FOR PRESSES SUCH AS
Y95J065144	BLUENET60	60°	154cm	Large Ruolan presses
Y95J065245	BLUENET40	40°	102cm	M.102 Ruolan 3B/600/700 Komairl 40°
Y95J065346	BLUENET29	29°	74cm	S.M.72,S.M.74 Ruolan Ob, 200
Y95J065447	BLUENET26	26°	66cm	M.O
Y95J065548	BLUENET23	23°	58cm	G.T.O52,S.M.52 and other small offset presses

Hoses



Code	SOD	DESCRIPTION
Y95J065649	a	Woven outer main air line 9mm ID
Y95J065750	b	Pneumatic tubing 12mm OD
Y95J065851		Pneumatic tubing 8mm OD
Y95J065952		Pneumatic tubing 6mm OD
Y95J066053		Pneumatic tubing 4mm OD
Y95J066154	c	Reinforced compressor hose 13mm ID
Y95J066255		Reinforced compressor hose 16mm ID
Y95J066356		Reinforced compressor hose 25mm ID
Y95J066457		Reinforced compressor hose 40mm ID
Y95J066558		Reinforced compressor hose 63mm ID
Y95J066659	d	Extreme pressure air cabinet hose 40mm ID
Y95J066760		Extreme pressure air cabinet hose 65mm ID
Y95J066861	e	Insulated water hose 12.5mm ID
Y95J066962	f	Blanket wash drain hose
Y95J067063	g	Feeder head air hose 13mm ID
Y95J067164		Feeder head air hose 10mm ID

Code	SOD	DESCRIPTION
Y95J067265		Feeder head air hose 6mm ID
Y95J067366	h	1/4"reinforced hose for Puffer Gun
Y95J067467		Blanket wash blue water tube
Y95J067568		Blanket wash black spieit tube
Y95J067669	i	12mmOD 8mmID
Y95J067770		8mmOD 5mmID
Y95J067871		6mmOD 4mmID
Y95J067972		4mmOD 2.5mmID
Y95J068073		3mmOD 2mmID
Y95J068174	j	22mmOD 15mmID
Y95J068275		13mmOD 6mmID
Y95J068376	k	110mmOD
Y95J068477		48mmOD
Y95J068578	l	85mmOD
Y95J068679		73mmOD 64ID
Y95J068780		56mmOD

Filter Bag

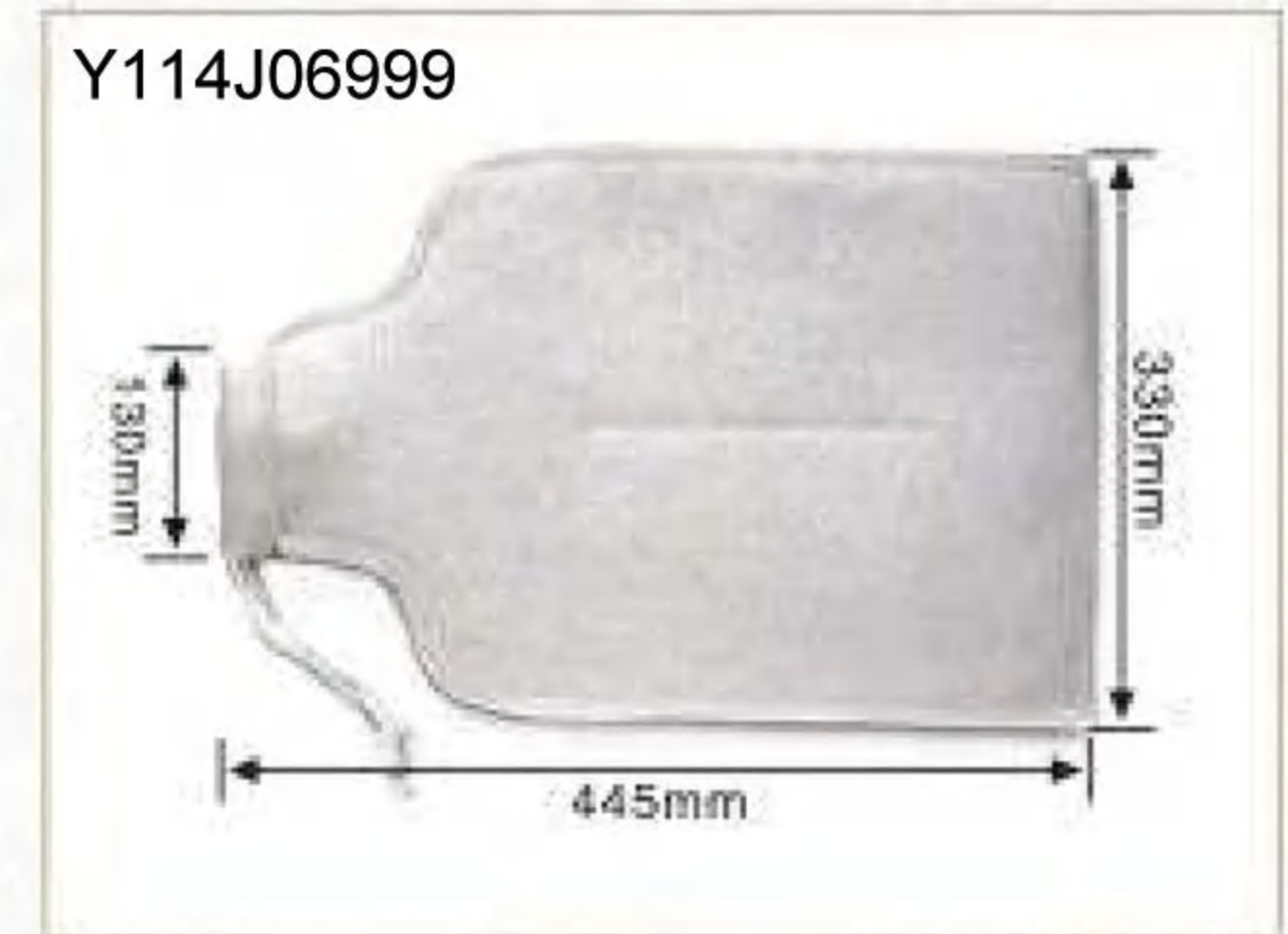

Paper Cutting Knife



Code	Machine Type	Dimensions
Pola玻拉		
Y99J08542	Pola 72	868*104*9.7
Y99J08552	Pola 76	925*110*9.7
Y99J08562	Pola 82	990*107*11.7
Y99J08572	Pola 92	1095*115*11.7
Y99J08582	Pola 1115	1390*160*13.75
Y99J08592	Pola 137	1605*160*13.75
MILER MATIANNI马田尼		
Y99J08602		520*140*70
Y99J08612	DSS.890	355*65*55*6
Y99J08622	DS217.1509	520*40*15/10
Y99J08632		360*40*15/10
EOTTEG一腾		
Y99J08642	115/JAC1150	1390*150*13.7
Y99J08652	115B/JAC1150	1410*150*13.7
WOLENBEIGE万能保		
Y99J08662	44FS100	500*115*10
Y99J08672		390*115*10
Y99J08682	38FS30	500*115*10
Y99J08692		424*115*10
Y99J08702	A43/30	560*115*10
Y99J08712		424*115*10

Code	Machine Type	Dimensions
Chine Paper Cutting国产		
Y99J08722	520	690*103*10
Y99J08732	670/607	780*103*10
Y99J08742	780	960*127*12.7
Y99J08752	820	960*107*12.7
Y99J08762	205	1065*127*12.7
Y99J08772	920	1080*127*12.7
Y99J08782	920S	1100*127*12.7
Y99J08792	1150	1390*160*12.7
Y99J08802	1150B	1390*160*13.75
Y99J08812	104	1520*127*12.7
Y99J08822	1300	1605*160*12.7
Y99J08832	1370B	1605*160*13.75
Y99J08842	1550	1785*160*12.7
Y99J08852	1550B	1790*160*12.7
Y99J08862	155	1785*160*13.75
Y99J08872	1660	1905*160*13.75
Y99J08882	1860	2120*160*13.75
Y99J08892	2200	2460*160*13.75

Cylinder Jackets



Code	Mode	Thickness	Length	Width
HAIDLEBERC				
Y97J07501	P.M46	0.3	46	36
Y97J07511	P.M52	0.3	52	36
Y97J07521	G.T.O46	0.3	46	32
Y97J07531	G.T.O52	0.3	52	36
Y97J07541	S.M52	0.3	52	36
Y97J07551	M.O65	0.3	65	48
Y97J07561	S.M72	0.3	72	52
Y97J07571	S.M74	0.3	74	52
Y97J07581	S.M102	0.3	102	72
Y97J07591	KOR	0.6	57	40
Y97J07601	KORA57	0.6	57	46
Y97J07611	KORD62	0.6	62	46
Y97J07621	KORD64	0.6	64	46
Y97J07631	KORS72	0.6	72	52
Y97J07641	KS	0.6	52	38

Code	Mode	Thickness	Length	Width
HAIDLEBERC				
Y97J07651	KSB	0.6	57	40
Y97J07661	KSBA	0.6	58.5	46
Y97J07671	KSBAZ	0.6	57	46
Y97J07681	KSD	0.6	64	46
Y97J07691	S(QHZ)	0.6	72	54
Y97J07701	SB-SBG	0.6	77	56
Y97J07711	SBG	0.6	77	54
Y97J07721	SBB	0.6	82	57
Y97J07731	SBD	0.6	90	64
Y97J07741	SBD(SPECLAL)	0.6	89	64
RUOLAN				
Y97J07751	PRACTICA 00	0.3	52	36
Y97J07761	PRACTICA 00(NEW)	0.3	52	36
Y97J07771	PRACTICA 002COL	0.3	52	36
Y97J07781	PRACTICA 01	0.3	66	48
Y97J07791	RFOB	0.3	72	52
Y97J07801	REKORD	0.3	103	72
KOMAR1				
Y97J07811	SP26	0.3	68	46
Y97J07821	SP28	0.3	72	52

Polyethylene Terephthalate(PET)



Code	Specs
Y97J07831	0.1mm
Y97J07841	0.125mm
Y97J07851	0.175mm
Y97J07861	0.188mm

Anti Marking Paper/Film

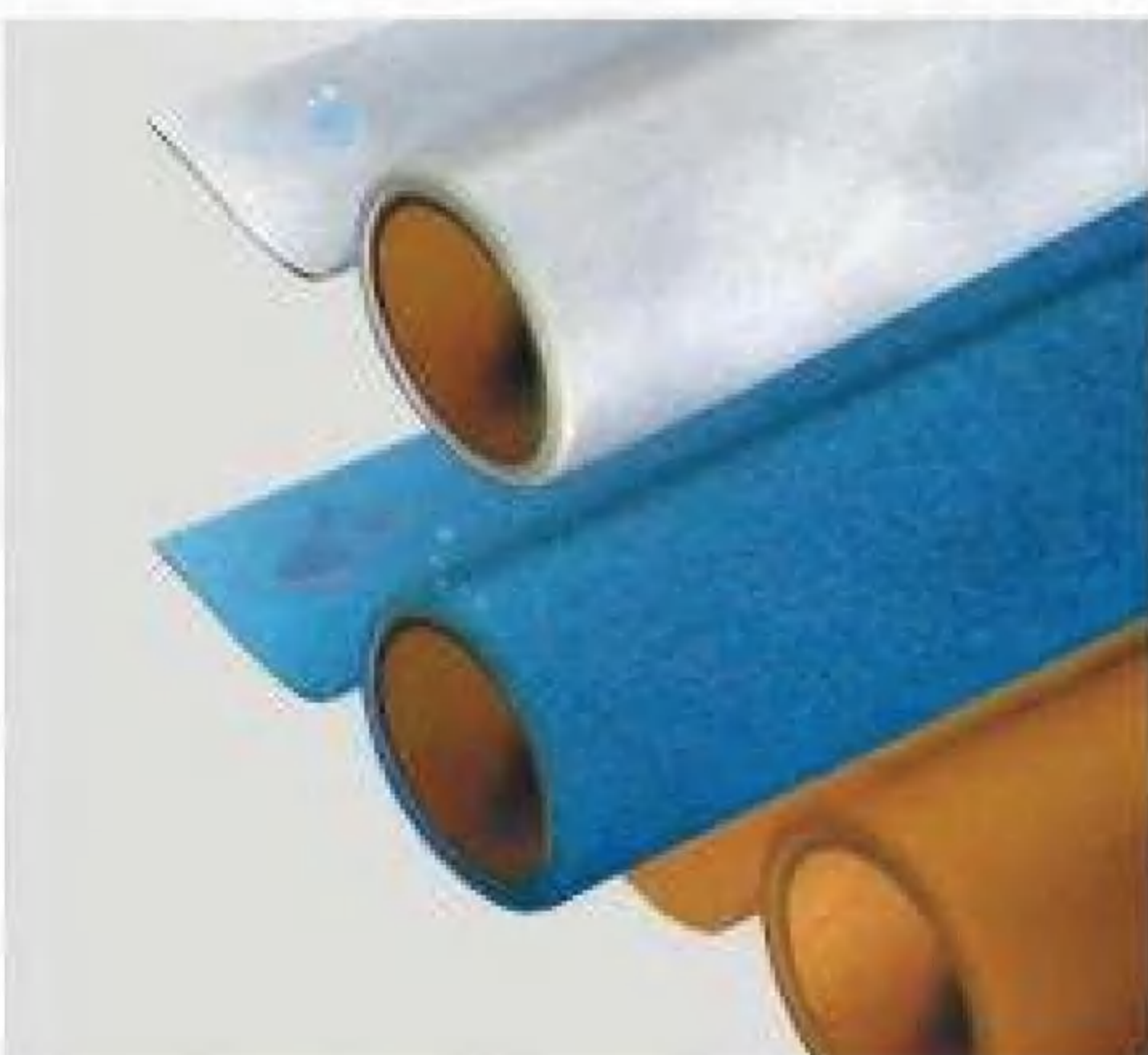

Anti Marking Paper 砂炮纸

Code	Mode	USE	Specs
Y97J07871	180#	Coated paper	1150mm*20M
Y97J07881	320#	Gu paper	1150mm*20M



Anti Marking Film 砂炮胶片

Code	Mode	USE	Specs
Y97J07891	180#	Coated paper	1150mm*20M
Y97J07901	320#	Gu paper	1150mm*20M

Auto Blanket Wash Cloth



SUPERTEX: Jumbo rolls for automatic blanket washing available in standard length 500 metres.

MINITEX: Minirolls for automatic blanket washing available in standard length 8 metres.

Code	Mode	MM	INCH
HAIDLEBERC			
Y98J07911	SPEEDMASTER 52	540	21.26"
Y98J07921	M.O 65	670	26.38"
Y98J07931	SPEEDMASTER 72	745	29.33"
Y98J07941	SPEEDMASTER 74	765	30.12"
Y98J07951	SPEEDMASTER 102	1050	41.34"
Y98J07961	WEB16	985	38.78"
K8A			
Y98J07971	K8A-RAPIDA72	785	30.12"
Y98J07981	K8A-RAPIDA104/105	1070	42.13"
Y98J07991	K8A-RAPIDA142	1460	57.48"
Y98J08001	K8A-RAPIDA162/162A	1660	65.35"

Code	Mode	MM	INCH
WEB OFFSET K8A			
Y98J08011	K8A 101	680	26.77"
Y98J08021	K8A COMPACTA216	985	38.78"
Y98J08031	K8A S 50	985	38.78"
Y98J08041	K8A KOMPRESSOR 217	985	38.78"
Y98J08051	K8A S 60	985	38.78"
M.A.N.RUOLAN			
Y98J08061	RUOLAN 200	745	29.33"
Y98J08071	RUOLAN REKORD 111B	1050	41.34"
Y98J08081	RUOLAN 600	1050	41.34"
Y98J08091	RUOLAN 700	1050	41.34"
Y98J08101	RUOLAN 800/5	1340	52.76"
Y98J08111	RUOLAN 800/6	1440	56.69"
MATIANNI			
Y98J08121	MATIANNI TP-104	1060	41.73"
KOMAR1			
Y98J08131	KOMAR1 26°SPRINT	684	25.93"
Y98J08141	KOMAR1 LITHRONE26	680	26.77"
Y98J08151	KOMAR1 28°SPRINTE LITHRONE	745	29.33"
Y98J08161	KOMAR1 40°	1040	40.94"
Y98J08171	KOMAR1 40°LITHRONE	1050	41.34"
Y98J08181	KOMAR1 LITHRONE 50	1350	53.15"

GTO/MO Perforating Wheels

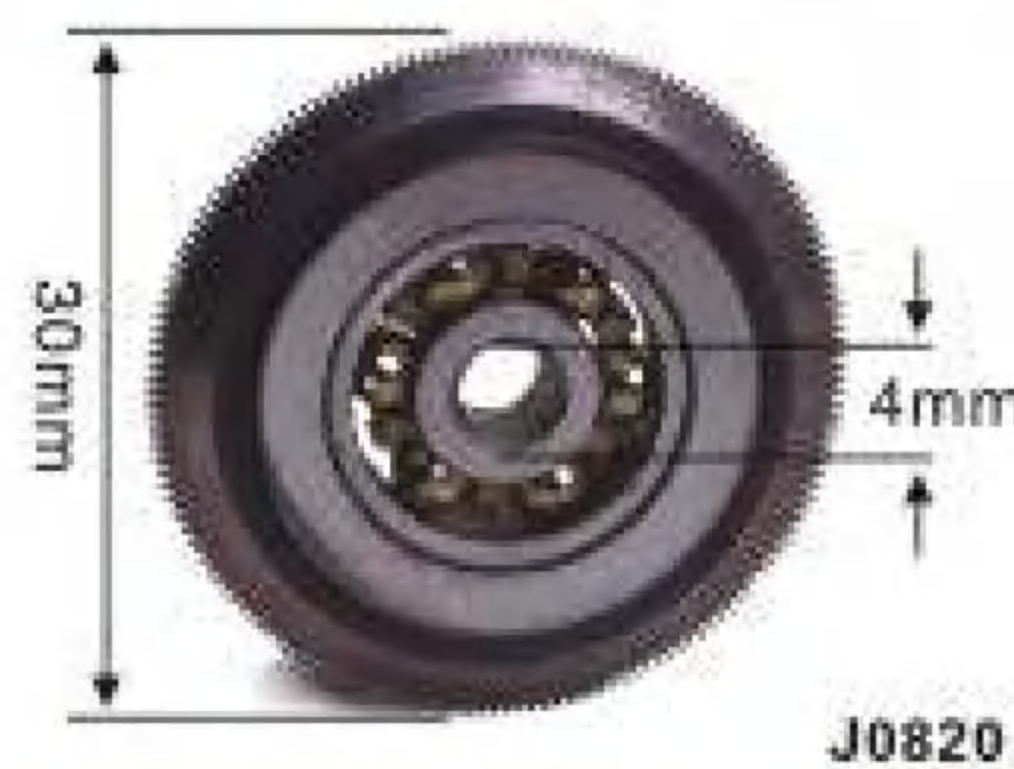
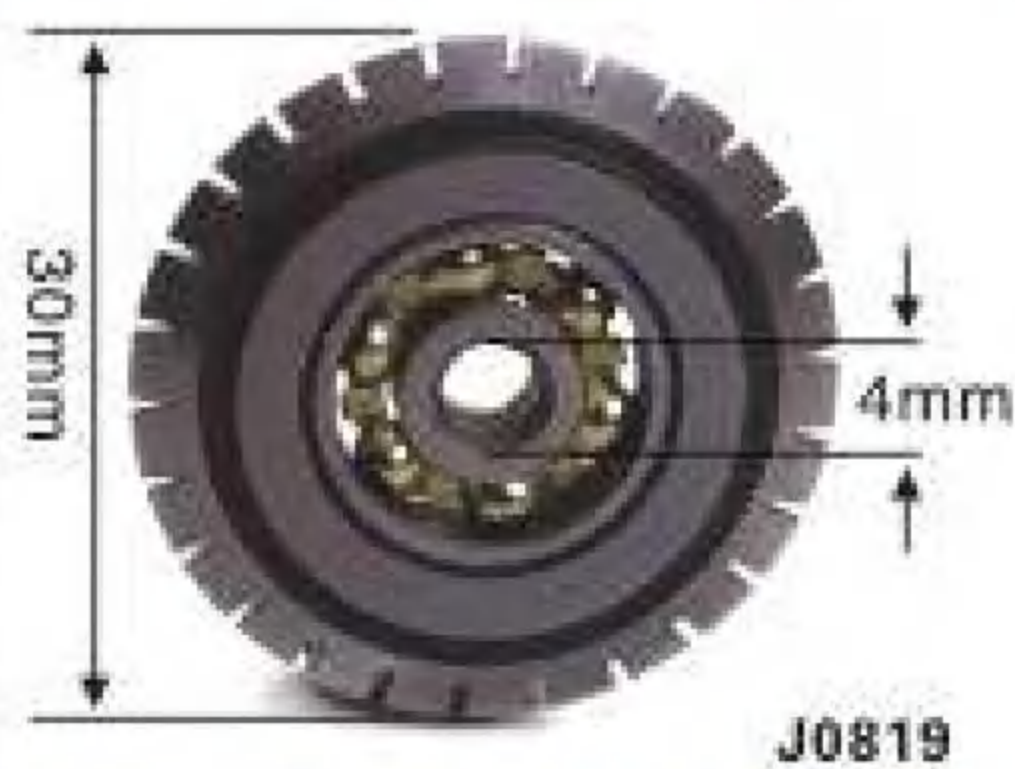

GTO/MO (26齿) 打孔轮

GTO/MO (170齿) 打孔轮

GTO/MO压摺痕轮

GTO/MO (26齿) 裁切轮

Knife Guards



Size: 60mm Width

Code	长度/Length	Code	长度/Length
Y98J08232	432mm	Y98J08302	700mm
Y98J08242	440mm	Y98J08312	950mm
Y98J08252	470mm	Y98J08322	1100mm
Y98J08262	480mm	Y98J08332	1120mm
Y98J08272	570mm	Y98J08342	1400mm
Y98J08282	585mm	Y98J08352	1500mm
Y98J08292	600mm	Y98J08362	1700mm

Underpacking Paper

Products Characteristic

1. Stable thickness: it will not expansion and deform due to the introgression of the fountain of solutions and other print media.
2. Adjust pressure: As a cushion to decrease the damage of printing blanket while when under pressure

Thickness

10C 15C 20C 25C 30C 40C 50C



Underpacking Foils

Feature

Switzerland FOLEX H 45 UNDERPACKING FOIS is a professional under-packing foil for PS plate cylinder. It can keep the thickness between the printing plate and the cylinder of printing blanket accurate and not deform. Meanwhile, it can improve the printing quality. So it is widely used by the printing machines of Heidelberg, RolandKBA, Komori, Gaussian etc.

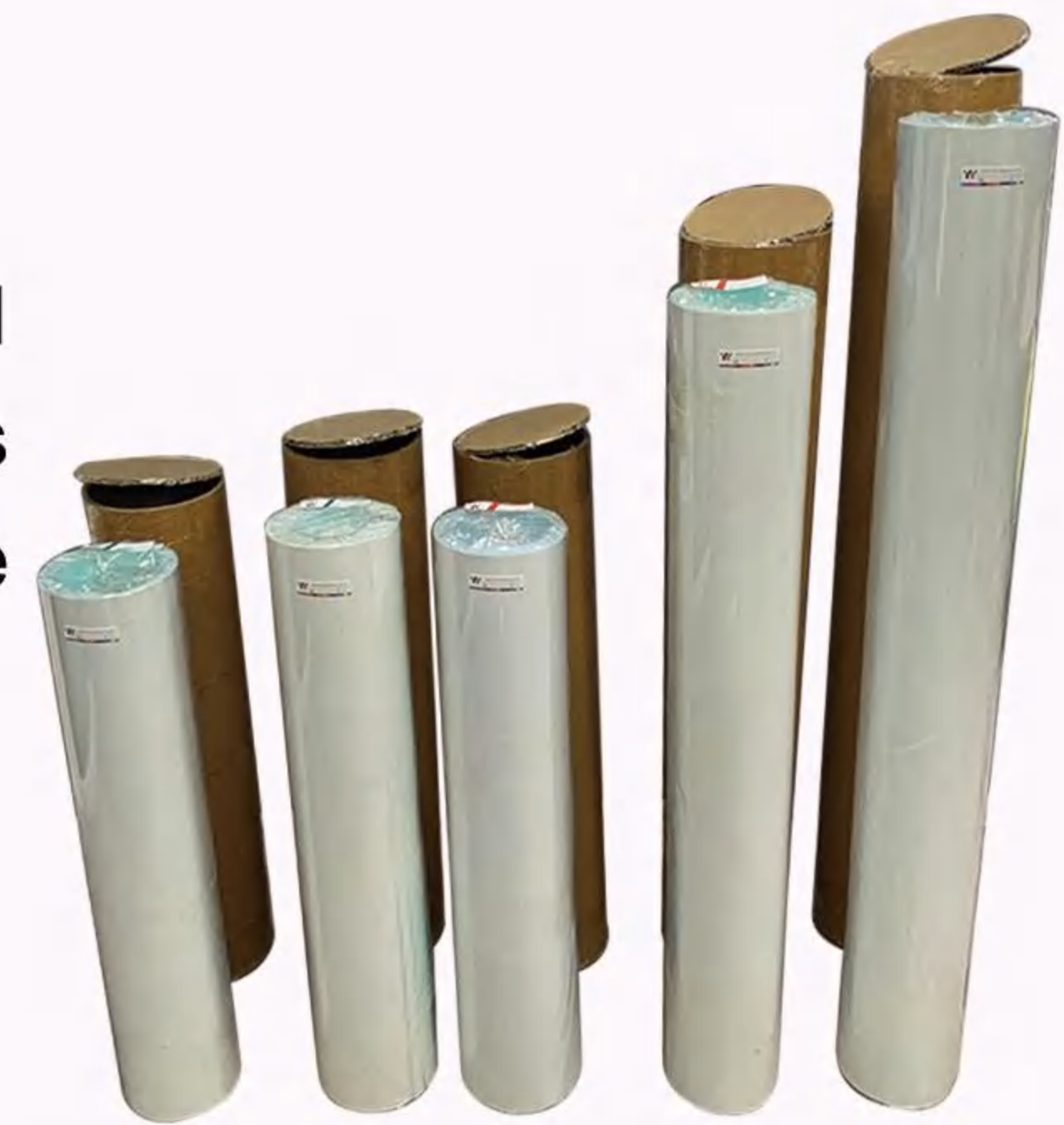

Products Characteristic

1. Stable thickness: it will not expansion and deform due to the introgression of the fountain solutions and other print media.
2. Long-time viscosity: It can keep over 8 months to 10 months
3. Surface construction: Compare to the ordinary under-packing foils, it has the special micro gas leading groove.



Underpacking Blanket

Features

1. High performance and consistent instrument control
2. Closed cell compressible layer and excellent release characteristics
3. High ink affinity surface rubber
4. Stable fabric, high ink absorption and low deformation
5. Super sharp point structure
6. Durability and stable quality

Thickness: 0.65mm/1.0mm

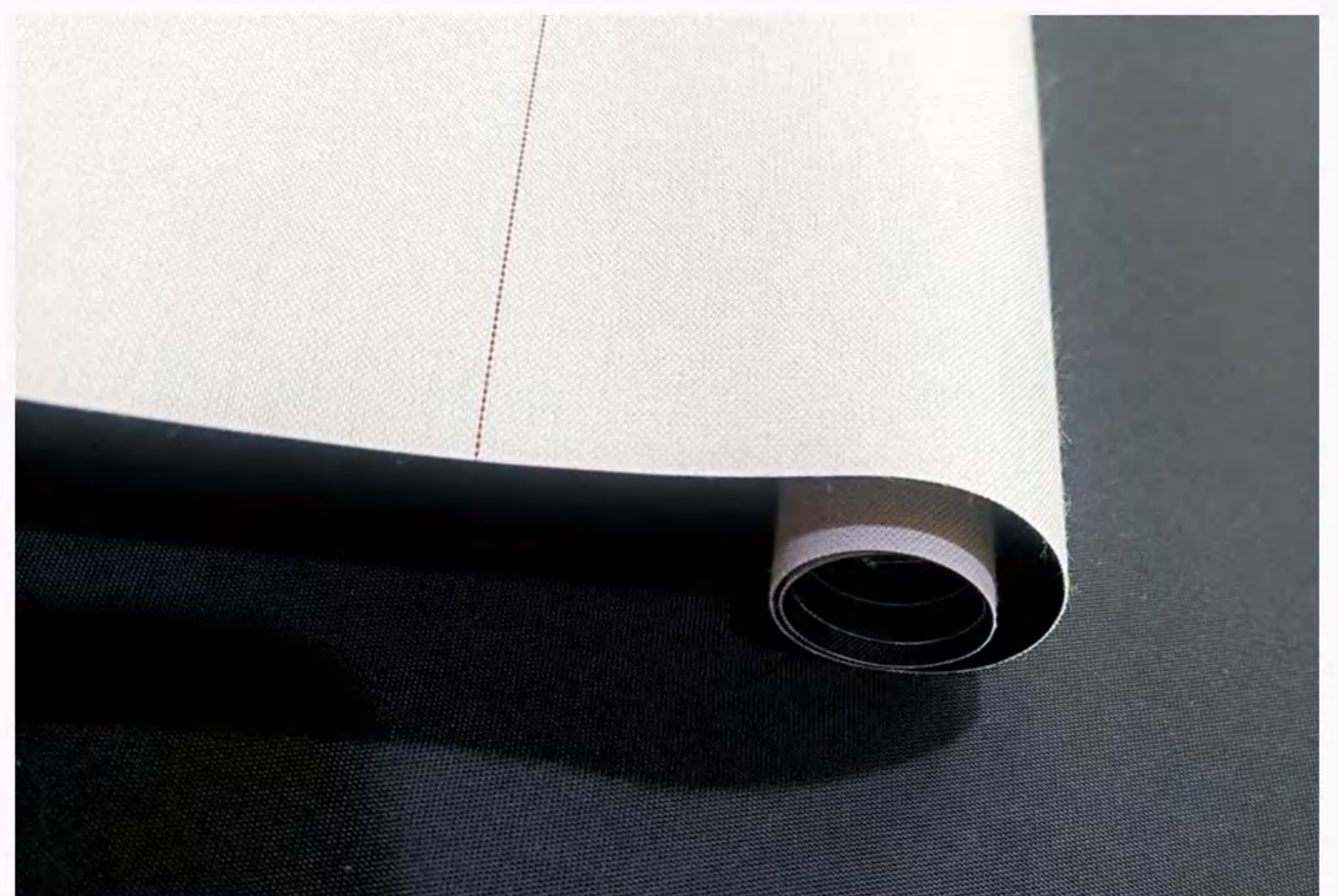

Gallium Iodine lamp

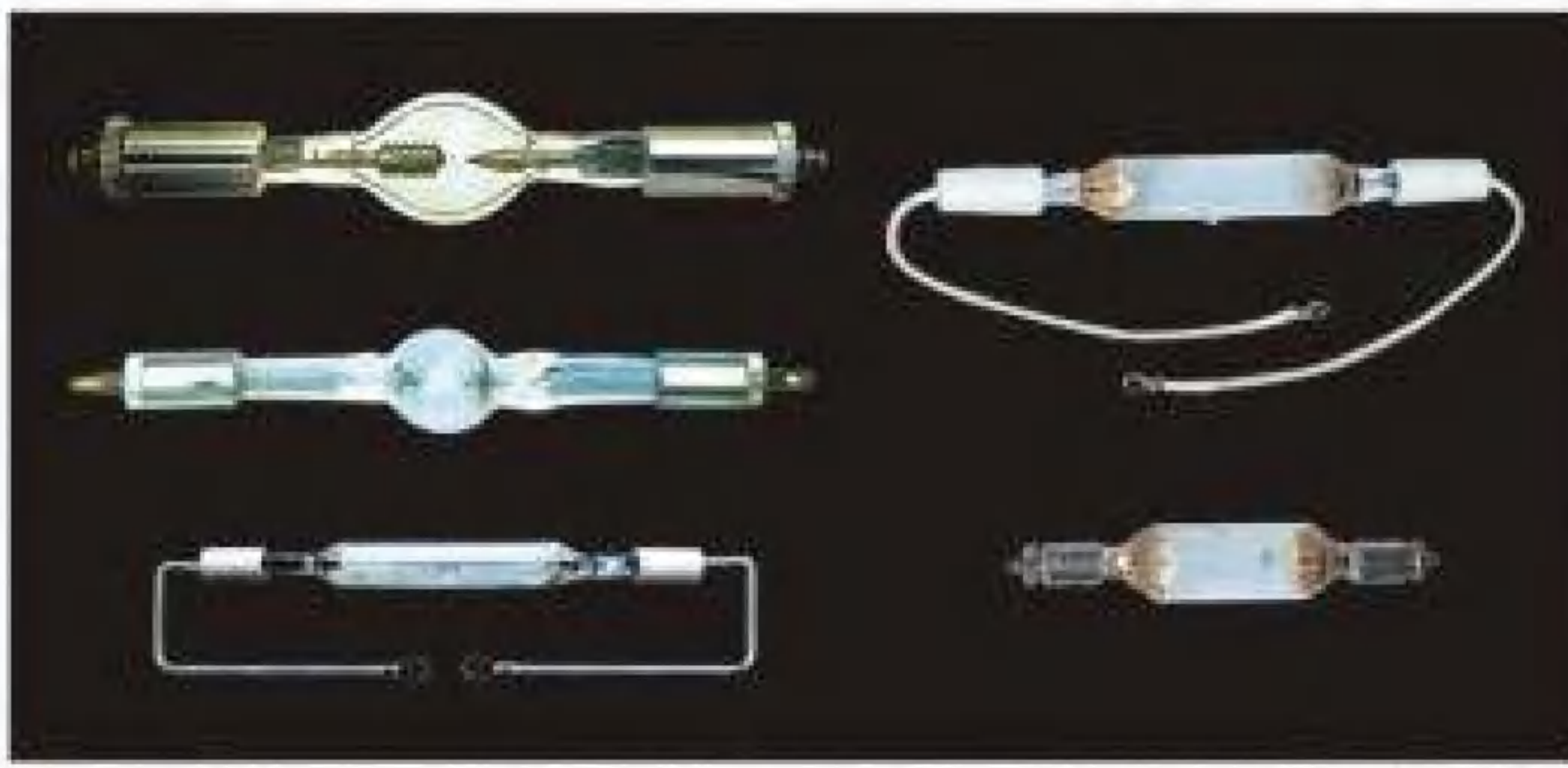

IODINE GALLIUM LAMP SPECIAL SPECIFICATIONS CUSTOMIZED FORM

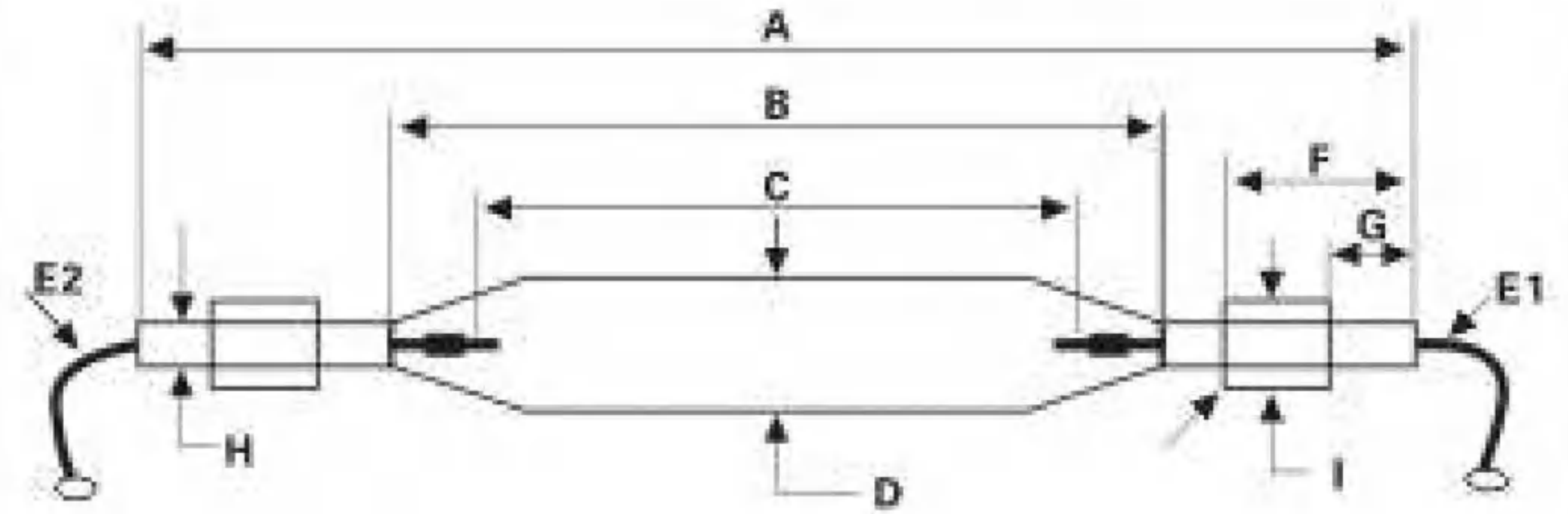

■ GALLIUM IODINE LAMP WITH WIRES

Code	VOLTAGE	POWER	TOTAL LENGTH(mm)			
			I	II	III	IV
Y100J08902	220V	1KM	170	190	200	210
Y100J08912	220V	2KM	200	210	215	270
Y100J08922	220V	3KM	215	270	-	-
Y100J08932	220V	4KM	280	-	-	-
Y100J08942	380V	1KM	176	190	210	-
Y100J08952	380V	2KM	210	215	270	-
Y100J08962	380V	3KM	210	270	-	-
Y100J08972	380V	4KM	240	280	-	-

Code	Description	Measured Dimension(mm)
A	Tatol Length(总长)	
B	Shoulder Length(侧翼长度)	
C	Arc Length (弧长)	
D	Diameter(直径)	
E	Lead lengthE1/E2(导线长度)	Side
F	Basa(全长)	
G	Basa(外端长度)	
H	Basa(外端直径)	
I	Basa(直径)	

■ GALLIUM IODINE LAMP WITH NUT

Code	VOLTAGE	POWER	TOTAL LENGTH(mm)			
			I	II	III	IV
Y100J08982	200V	1KM	210	-	-	-
Y100J08992	200V	2KM	210	270	-	-
Y100J09002	200V	3KM	270	-	-	-
Y100J09012	380V	2KM	210	270	-	-
Y100J09022	380V	3KM	160	270	-	-
Y100J09032	380V	4KM	270	-	-	-

Other Additional Information(附加说明)	
Sockal(孔) (直出线或侧出线)	Ceramic(陶瓷)
Lamp Voltage (灯电压)	V
Lamp Current (灯的电流)	A①
Lamp Power (灯的功率)	kw (Kindly confirm)
Terminal type (终端设备 类型) 端子	O型或Y型或 (O)
Doping(加添加剂)	(铁, 铯)
Power / cm	w/cm

Lamps



Code	SOD	DESCRIPTION
Y100J09042	a	Tube for dlivery CD74(720mm)
Y100J09052		Lithrone 26/28 delivery lamp
Y100J09062	b	Col matching lube for CPC ovoreadlight
Y100J09072	c	Tube for delimory SM102 (970mm)
Y100J09082	d	Tube tor daliwory SM102/S cylinders(600mm)
Y100J09092	e	North light tube for CPC overhead lighi(old)
Y100J09102	f	Tube for delvery Mo/Polar76
Y100J09112	g	Faed pile SM102CD/SM72tronie delivery
Y100J09122		Tube for feed end Komori Lithrone 26/28
Y100J09132	h	Tube for delivery K-ofset/S-offset/SM72
Y100J09142	i	Tube for delivery GTO/SM52/PM46QM
Y100J09152		Tube for Gratlx Exactomat
Y100J09162		CD102 Feedboard lamp(CP2000)
Y100J09172	j	Delivery SM74/PM45leeder
Y100J09182	k	lamp for leedboard Printmadter QM46
Y100J09192	l	Potar Eltromat satety barrier 6v 5w
Y100J09202	m	Polar cut line lamp12v 36w
Y100J09212	n	Low energy tube for lay area SM102CD
Y100J09222		Low energy tube for Gratix Exactomat
Y100J09232	o	polar 78 cut line lamp halogen
Y100J09242	p	Polar Eltromat cut line/periscope 12v 45w
Y100J09252	q	Polar/Wohlenberg cutline 24v48w
Y100J09262	r	Polar Eltromat satety barrier 12v21w
Y100J09272	s	Weko powdercontrol unit

Cutting Sticks



Code	Mode	Specs
Y101J09283	POLA 72	10*4.5*730
Y101J09293	POLA 76	10*4.5*770
Y101J09303	POLA 80/82	10*4.5*830
Y101J09313	POLA 92	10*4.5*930
Y101J09323	POLA 105/107	10*4.5*1080
Y101J09333	POLA 115	10*4.5*1160
Y101J09343	POLA 132	10*4.5*1330
Y101J09353	POLA 145	10*4.5*1460
Y101J09363	POLA 155	10*4.5*1560
Y101J09373	POLA 171	10*4.5*1700
Y101J09383	POLA 80/82	10*4.5*830
Y101J09393	POLA 92	10*4.5*930
Y101J09403	POLA 105/107	10*4.5*1080
Y101J09413	POLA 115	10*4.5*1160
Y101J09423	POLA 155	10*4.5*1560
Y101J09433	WOLENBEIDE	18*4*878
Y101J09443	WOLENBEIDE	18*4*1080
Y101J09453	WOLENBEIDE	18*4*1335
Y101J09463	WOLENBEIDE	18*4*1560
Y101J09473	WOLENBEIDE	18*4*1560
Y101J09483	WOLENBEIDE	11*3*909
Y101J09493	WOLENBEIDE	11*3*1157
Y101J09503	WOLENBEIDE	13*13*926
Y101J09513	WOLENBEIDE	13*13*1157
Y101J09523	WOLENBEIDE	15*15*1157
Y101J09533	WOLENBEIDE	10*4*770
Y101J09543	WOLENBEIDE	10*4*930
Y101J09553	WOLENBEIDE	10*4*1190
Y101J09563	WOLENBEIDE	13*13*1157
Y101J09573	SCHNEIDER SENATOR	12*3*821
Y101J09583	SCHNEIDER SENATOR	12*3*1151

Code	Mode	Specs
Y101J09593	SCHNEIDER SENATOR	12*3*1551
Y101J09603	SCHNEIDER SENATOR	14*14*821
Y101J09613	SCHNEIDER SENATOR	14*14*1061
Y101J09623	SCHNEIDER SENATOR	14*14*1370
Y101J09633	SCHNEIDER SENATOR	14*14*1600
Y101J09643	MANDELLILLM	16*16*765
Y101J09653	MANDELLILLM	16*16*930
Y101J09663	MANDELLILLM	16*16*1080
Y101J09673	MANDELLILLM	16*16*1335
Y101J09683	MANDELLILLM	16*16*1575
Y101J09693	HEROLD	18*5*840
Y101J09703	HEROLD	18*5*930
Y101J09713	HEROLD	18*5*1080
Y101J09723	HEROLD	18*5*1160
Y101J09733	THREELATERAL/TRILATERALE	24*4*1200
Y101J09743	THREELATERAL/TRILATERALE	41*4*1200
Y101J09753	THREELATERAL/TRILATERALE	60*4*1200
Y101J09763	THREELATERAL/TRILATERALE	11*4*1200
Y101J09773	THREELATERAL/TRILATERALE	13*4*1200
Y101J09783	PIVANO PERFECTA	10*5*840
Y101J09793	PIVANO PERFECTA	10*5*1138
Y101J09803	PIVANO PERFECTA	10*5*1368
Y101J09813	PIVANO PERFECTA	10*5*1715
Y101J09823	PIVANO PERFECTA	19*19*838
Y101J09833	PIVANO PERFECTA	19*19*1073
Y101J09843	PIVANO PERFECTA	19*19*1130
Y101J09853	PIVANO PERFECTA	12*4*1070
Y101J09863	SAROGLIA	20*20*890
Y101J09873	SAROGLIA	20*20*1065
Y101J09883	SAROGLIA	20*20*1325
Y101J09893	PIVANO SAROGLIA	10*10*850
Y101J09903	PIVANO SAROGLIA	10*10*1095
Y101J09913	PIVANO SAROGLIA	10*10*1325
Y101J09923	OMAC NEBIOLO	9.5*5*1505
Y101J09933	OMAC NEBIOLO	9.7*5*760
Y101J09943	OMAC NEBIOLO	9.7*5*840
Y101J09953	OMAC NEBIOLO	9.7*5*1120
Y101J09963	OMAC NEBIOLO	9.7*5*1230
Y101J09973	OMAC NEBIOLO	9.7*5*1500
Y101J09983	OMAC NEBIOLO	15*15*760
Y101J09993	OMAC NEBIOLO	15*15*830
Y101J10003	OMAC NEBIOLO	15*15*930
Y101J10013	OMAC NEBIOLO	15*15*1120
Y101J10023	OMAC NEBIOLO	15*15*1320
Y101J10033	OMAC NEBIOLO	15*15*1555

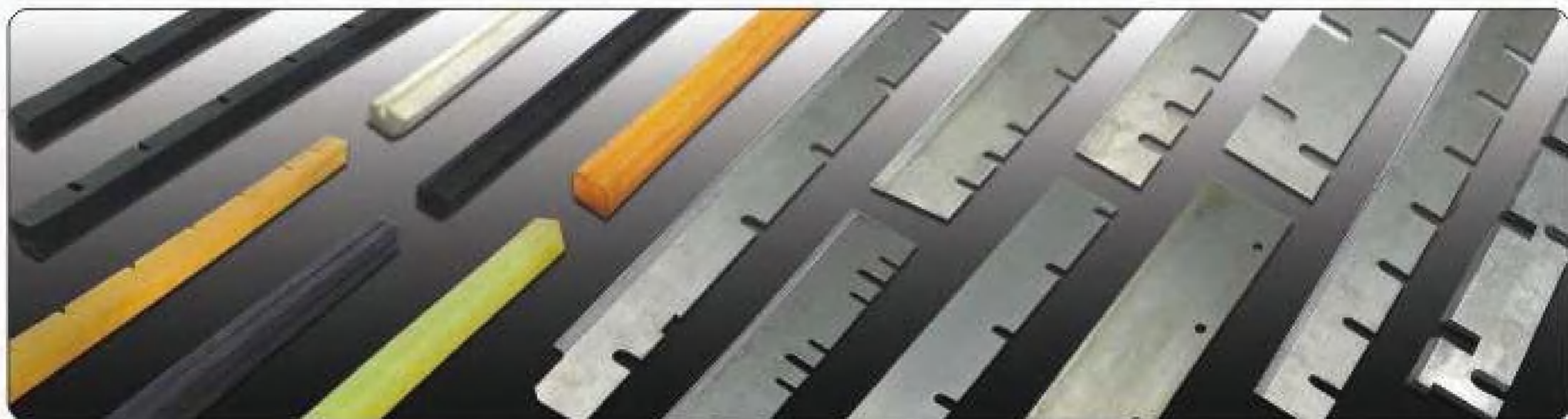

Filters

ID=Inside Diameter

OD=Outside Diameter

H=Height (mm)

						
ID=6mm OD=38mm H=130mm Y102J10041	ID=9mm OD=34mm H=52mm Y102J10051	ID=10mm OD=29mm H=30mm Y102J10061	ID=10mm OD=29mm H=35mm Y102J10071	ID=10mm OD=29mm H=39mm Y102J10081	ID=12mm OD=33mm H=66mm Y102J10091	ID=13mm OD=28mm H=65mm Y102J10101
						
ID=13mm OD=39mm H=35mm Y102J10111	ID=14mm OD=39mm H=29mm Y102J10121	ID=13mm OD=41mm H=63mm Y102J10131	ID=14mm OD=40mm H=52mm Y102J10141	ID=16mm OD=57mm H=53mm Y102J10151	ID=17mm OD=59mm H=54mm Y102J10161	ID=17mm OD=59mm H=63mm Y102J10171
						
ID=18mm OD=62mm H=52mm Y102J10181	ID=19mm OD=60mm H=53mm Y102J10191	ID=20mm OD=45mm H=129mm Y102J10201	ID=20mm OD=58mm H=35mm Y102J10211	ID=21mm OD=58mm H=37mm Y102J10221	ID=20mm OD=58mm H=50mm Y102J10231	ID=20mm OD=58mm H=61mm Y102J10241
						
ID=20mm OD=62mm H=60mm Y102J10251	ID=20mm OD=63mm H=64mm Y102J10261	ID=22mm OD=46mm H=87mm Y102J10271	ID=23mm OD=51mm H=88mm Y102J10281	ID=25mm OD=38mm H=186mm Y102J10291	ID=25mm OD=50mm H=127mm Y102J10301	ID=24mm OD=65mm H=73mm Y102J10311
						
ID=25mm OD=41mm H=122mm Y102J10321	ID=25mm OD=46mm H=170mm Y102J10331	ID=25mm OD=47mm H=170mm Y102J10341	ID=26mm OD=53mm H=51mm Y102J10351	ID=26mm OD=68mm H=29mm Y102J10361	ID=27mm OD=60mm H=92mm Y102J10371	ID=27mm OD=62mm H=30mm Y102J10381
						
ID=28mm OD=50mm H=125mm Y102J10391	ID=28mm OD=54mm H=150mm Y102J10401	ID=28mm OD=70mm H=198mm Y102J10411	ID=30mm OD=53mm H=85mm Y102J10421	ID=30mm OD=66.5mm H=247mm Y102J10431	ID=30mm OD=58mm H=155mm Y102J10441	ID=30mm OD=58mm H=151mm Y102J10451

						
ID=31mm OD=50mm H=160mm Y103J10461	ID=30mm OD=51mm H=160mm Y103J10471	ID=32mm OD=70mm H=80mm Y103J10481	ID=32mm OD=70mm H=79mm Y103J10491	ID=38mm OD=60mm H=69mm Y103J10501	ID=38mm OD=63mm H=170mm Y103J10511	ID=38mm OD=52mm H=160mm Y103J10521
						
ID=38mm OD=70mm H=73mm Y103J10531	ID=38mm OD=80mm H=134mm Y103J10541	ID=38mm OD=80mm H=134mm Y103J10551	ID=39mm OD=62mm H=44mm Y103J10561	ID=39mm OD=64mm H=118mm Y103J10571	ID=39mm OD=79mm H=136mm Y103J10581	ID=40mm OD=65mm H=70mm Y103J10591
						
ID=40mm OD=65mm H=118mm Y103J10601	ID=40mm OD=79mm H=137mm Y103J10611	ID=40mm OD=80mm H=136mm Y103J10621	ID=40mm OD=84mm H=125mm Y103J10631	ID=41mm OD=98mm H=205mm Y103J10641	ID=41mm OD=99mm H=200mm Y103J10651	ID=44mm OD=60mm H=64mm Y103J10661
						
ID=46mm OD=90mm H=146mm Y103J10671	ID=46mm OD=95mm H=136mm Y103J10681	ID=46mm OD=95mm H=138mm Y103J10951	ID=55mm OD=75mm H=62mm Y103J10701	ID=50mm OD=26mm H=52mm Y103J10711	ID=60mm OD=84mm H=75mm Y103J10721	ID=60mm OD=95mm H=71mm Y103J10731
						
ID=60mm OD=100mm H=268mm Y103J10741	ID=60mm OD=144mm H=144mm Y103J10751	ID=61mm OD=99mm H=65mm Y103J10761	ID=62mm OD=142mm H=142mm Y103J10771	ID=69mm OD=99mm H=77mm Y103J10781	ID=69mm OD=100mm H=71mm Y103J10791	ID=69mm OD=126mm H=125mm Y103J10801
						
ID=70mm OD=125mm H=140mm Y103J10811	ID=88mm OD=148mm H=222mm Y103J10821	ID=90mm OD=148mm H=238mm Y103J10831	ID=90mm OD=50mm H=160mm Y103J10461	ID=31mm OD=50mm H=160mm Y103J10461	ID=31mm OD=50mm H=160mm Y103J10461	ID=31mm OD=50mm H=160mm Y103J10461
						
ID=164mm OD=270mm H=240mm Y103J10881	Y103J10891	Y103J10901	Y103J10911	Y103J10921		Y103J10931

Wash Up Blades



Legend: M=Metal with Rubber P=Plastic E=EPDM Rubber C=Combination T=Tufnol B=Brass

Code	Mode	M	L	W	T	H
Haidleberc						
Y104J10943	TOK(plastic)	P	283	43	3.0	4
Y104J10953	TOK(metall)	M	283	43	0.5	4
Y104J10963	QK MASTER	P	375	43	3.0	5
Y104J10973	G.T.O46	M	500	60	0.5	5
Y104J10983	G.T.O46 Numbering Unit	C	448	40	6.0	3
Y104J10993	G.T.O52 PRINTMASTER	M	560	60	5.0	6
Y104J11003	G.T.O52 Numbering Unit	C	508	40	6.0	3
Y104J11013	M.O	M	710	60	0.5	8
Y104J11023	M.O A/W(short)	M	692	60	0.5	7
Y104J11033	M.O(rigid)	M	710	60	2.0	8
Y104J11043	M.O (spectal length)	M	720	60	5.0	8
Y104J11053	M.O Numbering Unit	C	648	52	6.0	3
Y104J11063	S.M 52	M	605	46	0.5	7
Y104J11073	S.M 52Numbering Unit	M	636	28	0.5	6
Y104J11083	S.M 72	M	790	60	0.5	11
Y104J11093	S.M 72 VP	M	753	40	5.0	9
Y104J11103	S.M 72A/W	M	742	60	0.5	8
Y104J11113	S.M 74 (w/slote)	M	822	57	0.5	9
Y104J11123	Printmaster74	M	822	57	0.5	9
Y104J11133	SM74/PM74(with 2 rows houles)	M	822	67	0.5	18
Y104J11143	S.M 74 (long+w/slote)	M	826	57	0.5	9
Y104J11153	S.M CD74/XL75 (wrstois)	M	847	47	5.0	9
Y104J11163	S.M 102(w/slote)	M	1090	60	0.5	11
Y104J11173	S.M 102+CD102(w/slote)	M	1090	60	5.0	11
Y104J11183	CD102 57mm(narrow profile+w/slote)	M	1090	57	0.5	11
Y104J11193	S.M 102 A/W	M	1042	60	0.5	11
Y104J11203	S.M 102 A/W New	M	1042	57	0.5	11
Y104J11213	S.M 102 VP	M	1052	40	0.5	11
Y104J11223	S.M XL105(w/slote)	M	1125	41	5.0	21
Y104J11233	SOR Flexi(new model)	M	890	60	0.5	9
Y104J11243	SOR Rigid(old model)	M	890	50	2.0	10
Y104J11253	SORK Flexi	M	710	60	5.0	8
Y104J11263	SORK 65 Rigid	M	721	50	2.0	12
Y104J11273	SORM Rigid	M	790	50	2.0	12
Y104J11283	SORM/Z FlexiPre1995	M	753	42	0.5	9
Y104J11293	SORM/Z Flexi(w/9holes+2slote)	M	790	60	0.5	11
Y104J11303	SORD Flexi	M	960	60	0.5	10
Y104J11313	SORD Rigid	M	960	50	2.0	12
Y104J11323	SORS	M	1090	60	0.5	11
Y104J11333	KOR	M	600	50	2.0	10
Y104J11343	KORA	M	622	50	2.0	10
Y104J11353	KORD62	M	650	50	2.0	10
Y104J11363	KORD64	M	690	50	2.0	12
Y104J11373	KORS	M	760	50	2.0	12
Y104J11383	PLATEN10*15	C	390	51	6.0	5
Y104J11393	PLATEN13*18	C	470	61	6.0	6
Y104J11403	KS	T	530	46	1.0	8
Y104J11413	KSB-KSBA	T	575	46	1.0	8
Y104J11423	OHZ	T	720	46	1.0	10
Y104J11433	SB-SBG	T	770	46	1.0	10
Y104J11443	SBB	T	811	46	1.0	10
Y104J11453	SBG	T	833	46	1.0	8

Code	Mode	M	L	W	T	H
K8A						
Y104J11464	SRO	P	770	60	1.0	8
Y104J11474	SRO(old model)	M	770	50	0.5	8
Y104J11484	Rabidn 72	M	780	45	0.5	11
Y104J11494	Rabida 75	E	815	24	3.0	0
Y104J11504	Rebidg 75	P	815	24	3.0	0
Y104J11514	Rabida 104(narrow)	M	1130	46	0.5	0
Y104J11524	Rabide 104 (wide)	M	1130	51	0.5	0
Y104J11534	Rabidn 104(wide)	M	1130	51	0.5	12
Y104J11544	Rabida 105	M	1140	46	0.5	0
Y104J11554	RabidR 105	M	1140	55	0.5	11
Y104J11564	Rabida 105	P	1160	35	2.0	0
Y104J11574	Rabide 142	M	1510	66	0.5	17
Y104J11584	Rabida 160	M	1700	65	0.5	19
Y104J11594	Rapida 162	M	1710	65	0.5	19
Y104J11604	Compecta 560	M	1214	70	0.5	8
Y104J11614	Compacta	M	1060	95	0.5	6
Y104J11624	Compacta 215	M	1092	71	0.5	0
Y104J11634	Compecta 216	M	1030	68	5.0	7
Y104J11644	Compacta 417	M	1030	48	0.5	11
Y104J11654	Compecte 618	M	1515	70	0.5	10
Y104J11664	Comet(4/2)·(folder)	M	880	72	0.5	0
Y104J11674	Commander	M	1519	95	0.5	9
Y104J11684	Commende	M	1549	65	0.5	16
Y104J11694	Commander 60	M	1640	68	0.5	11
Y104J11704	Commander	M	1810	70	0.5	9
KOMAR1						
Y104J11714	L1the lon 20 Flaxi	M	580	48	0.5	8
Y104J11724	L1the lon 20 Rigid	M	690	36	2.0	5
Y104J11734	Sp 20	M	590	42	0.5	5
Y104J11744	L1tho lon 26A/W(narrow)	M	700	42	0.5	10
Y104J11754	L1the lon L26(special-narrow)	M	706	36	0.5	12
Y104J11764	Sp 710 Flexi	M	710	42	0.5	6
Y104J11774	Sp 710 Rigid	M	710	42	2.0	6
Y104J11784	SP 715 Flex	M	715	50	0.5	6
Y104J11794	Sp 715 Rigid	M	715	50	2.0	6
Y104J11804	Sp 715(special)	M	715	50	0.5	0
Y104J11814	L1the lon 26 A/W(wide)	M	716	47	0.5	10
Y104J11824	Sp 719 Flexi	M	719	44	0.5	8
Y104J11834	Sp 719 Rigid	M	719	44	2.0	6
Y104J11844	L1the lon 26 Flexi	M	726	36	0.5	6
Y104J11854	L1thelon 26-Lithrone 526	M	726	42	0.5	6
Y104J11864	L1the lon 26 Rigid	M	726	36	2.0	6
Y104J11874	L1thelan LS 28	P	730	35	1.0	10
Y104J11884	L1the lan LS 26	M	730	35	0.5	10
Y104J11894	Speclal A	M	754	40	0.5	9
Y104J11904	L1the lon 28 A/W	P	765	47	6.0	11
Y104J11914	L1the lon 28 A/W	M	766	47	0.5	11
Y104J11924	L1thelon 28	M	775	47	0.5	11
Y104J11934	L1the lon 28	M	780	42	0.5	8
Y104J11944	L1the lon 28 Flexi	M	785	42	0.5	6
Y104J11954	L1ttelan 28 Flexl (new style)	M	786	37	0.5	8
Y104J11964	L1the lon 28 Rigid	M	785	37	2.0	6

Code	Mode	M	L	W	T	H
Y105J11974	Lithe1on28(special for UV)	P	790	36	5.8	6
Y105J11984	Spicta29	P	805	47	5.0	11
Y105J11994	Spicta29	M	805	47	0.5	11
Y105J12004	Spicta29	P	806	38	1.0	11
Y105J12014	S29P	P	820	38	1.0	11
Y105J12024	L32	P	892	43	5.0	6
Y105J12034	L32	M	892	43	0.5	6
Y105J12044	L32	M	892	47	0.5	12
Y105J12054	Lithe1on 40 Coeting unit	M	1050	51	0.5	9
Y105J12064	Sydem40(95.35mm H/C)	M	1060	47	0.5	11
Y105J12074	Lithe1on 40	P	1067	47	5.0	15
Y105J12084	Lithe1on 40	M	1067	47	0.5	15
Y105J12094	Lithe1on 40 A/W	P	1076	47	5.0	8
Y105J12104	Lithe1on 40 A/W	P	1076	47	5.0	15
Y105J12114	Lithe1on 40 A/W	P	1076	50	5.0	8
Y105J12125	Lithe1on 40 A/W	P	1076	50	5.0	15
Y105J12135	Lithe1on 40 A/W	M	1077	42	0.5	15
Y105J12145	L40 A/W(old-47mm wide)	M	1077	47	0.5	15
Y105J12155	Lithe1on 40 (slots)	M	1090	43	0.5	15
Y105J12165	Lithe1on 40	M	1090	47	0.5	15
Y105J12175	Lithe1on 40	M	1090	47	0.5	15
Y105J12185	Lithe1on 40 A/W	P	1094	47	5.0	8
Y105J12195	Lithe1on 40 A/W	P	1094	47	5.0	15
Y105J12205	Lithe1on 40 A/W	P	1094	50	5.0	8
Y105J12215	Lithe1on 40 A/W	P	1094	50	5.0	15
Y105J12225	Lithe1on 40 flexi	M	1094	50	0.5	8
Y105J12235	Lithe1on 40 Rigld	M	1094	50	2.0	8
Y105J12245	Lithe1on 40	M	1098	52	0.5	15
Y105J12255	Lithe1on 40	P	1098	52	0.5	15
Y105J12265	Lithe1on	P	1100	50	5.0	0
Y105J12275	Lithe1on 40	M	1105	50	0.5	15
Y105J12285	Lithe1on 40	P	1105	50	1.0	15
Y105J12295	Lithe1on S40 (new model)	P	1110	47	1.0	15
Y105J12305	Lithe1on 40(old47mm wide)	M	1110	47	0.5	15
Y105J12315	Lithe1on 40	P	1110	47	5.0	15
Y105J12325	Lithe1on 40 A/W	P	1111	50	1.0	15
Y105J12335	Lithe1on 44	M	1120	52	0.5	15
Y105J12345	Lithe1on 44	M	1178	47	0.5	17
Y105J12355	Lithe1on S44SP(opper)pin7244501501	P	1185	50	1.0	16
Y105J12365	Lithe1on 44	M	1190	50	2.0	9
Y105J12375	Lithe1on 44	P	1190	50	5.0	9
Y105J12385	Lithe1on 44	M	1192	50	0.5	17
Y105J12395	Lithe1on 44	P	1192	50	5.0	17
Y105J12405	Lithe1on 44 SP	M	1210	47	0.5	17
Y105J12415	Lithe1on 44 SP(lower)pin 7244650801	P	1126	50	1.0	17
Y105J12425	Lithe1on 50	P	1380	42	5.0	19
Y105J12435	Lithe1on 50	P	1385	50	5.0	19
Y105J12445	Lithe1on 50	M	1380	42	0.5	19
Y105J12455	Lithe1on 50	M	1380	48	0.5	19
Y105J12465	Lithe1on 50	M	1379	50	0.5	10
Y105J12475	Sydem20(Web O/S 8pages)	M	590	58	0.5	7
Y105J12485	C20 MiniWeb	M	590	48	0.5	7
Y105J12495	8PP Heal SetWeb	M	590	50	0.5	7
Y105J12505	Sydem35(Web O/S 16pages)	M	980	50	0.5	13
Y105J12515	Sydem352(Web O/S 32pages)	M	970	50	0.5	13
Y105J12525	Sydem38(Web O/S 18pages)	M	1029	47	0.5	11
Y105J12535	Sydem40(Web O/S 16pages)	M	1029	47	0.5	11
MITSURISHI						
Y105J12545	1F	P	776	28	3.0	9
Y105J12555	1E/1F	M	778	33	0.5	9
Y105J12565	1E	P	784	40	2.0	8
Y105J12575	1E/1F/1G wislots(specingcrtrictr 104mm)	M	785	40	0.5	8
Y105J12585	1E/1F/1G wislots(specingcrtrictr 104mm)	M	785	40	0.5	8
Y105J12595	1G	M	785	37	0.5	8
Y105J12605	1E/1F/1G wislots(specingcrtrictr 105mm)	M	785	40	0.5	8
Y105J12615	2F	M	884	40	0.5	9
Y105J12625	Diamond 2000	M	877	33	0.5	10
Y105J12635	3F	P	1080	43	2.0	11
Y105J12645	3F-104	P	1080	31	2.0	11
Y105J12655	3F	P	1080	35	5.0	11
Y105J12665	3F/Diamond	M	1080	35	0.5	11
Y105J12675	3F	P	1090	45	2.0	11
Y105J12685	3F/G	M	1090	40	0.5	11
Y105J12695	3F/3G/Diamond3000	M	1095	40	0.5	11
Y105J12705	3F/3G/Diamond3000	M	1100	40	0.5	11

Code	Mode	M	L	W	T	H
Y105J12715	3F	M	1110	40	0.5	11
Y105J12725	3D	P	1110	44	2.0	11
Y105J12735	3D	M	1110	45	0.5	11
Y105J12745	3000	M	1126	40	0.5	11
Y105J12755	3F	M	1186	40	0.5	11
Y105J12765	4E	P	1190	45	2.0	13
Y105J12775	4E	M	1190	47	0.5	10
Y105J12785	5F	M	1348	45	0.5	19
Y105J12795	5F	M	1366	42	0.5	13
Y105J12805	6F/6G	M	1508	40	0.5	14
Y105J12815	Web PressL750	M	1050	50	0.5	11
Y105J12825	Web Press	M	1524	60	0.5	18
RUOLAN						
Y105J12835	300	M	816	60	0.5	8
Y105J12845	500(80.07V30.A078/AK)	P	818	60	1.0	8
Y105J12855	500	P	818	40	1.0	0
Y105J12865	Parva RP1	M	900	65	0.5	9
Y105J12875	Parva RP/PZP2	M	920	65	0.5	10
Y105J12885	Parva RP2C	M	995	65	0.5	10
Y105J12895	Rekord 3	M	1042	65	0.5	11
Y105J12905	Rekord RVK 3B	M	1075	65	0.5	11
Y105J12915	Rekord RVK 3B and604(lower unit)	M	1100	65	0.5	11
Y105J12925	Rekord RVK 3B	M	1132	65	0.5	12
Y105J12935	600(upper)	M	1090	65	0.5	11
Y105J12945	600(lower)	M	1100	65	0.5	11
Y105J12955	700(old)	M	1091	56	0.5	13
Y105J12965	700(enw)	M	1100	56	0.5	13
Y105J12975	700(new modei+wrslots)	M	1100	56	0.5	13
Y105J12985	700(007V143930)	P	1102	56	1.0	13
Y105J12995	700(new modei+onholes)	M	1105	40	0.5	0
Y105J13005	700(007V172730)	P	1108	40	1.0	0
Y105J13015	700(007V172730)(3mm)	P	1108	40	3.0	0
Y105J13025	Ultra4(1st)	M	1145	65	0.5	11
Y105J13035	Ultra4(2nd)	M	1195	65	0.5	11
Y105J13045	UltraV	M	1335	65	0.5	13
Y105J13055	UltraV	M	1335	65	0.5	0
Y105J13065	UltraVI	M	1475	65	0.5	14
Y105J13075	UltraVII&VIIB	M	1675	65	0.5	16
Y105J13085	UltraVII&VIIB	M	1710	65	0.5	16
Y105J13095	800V/VW	M	1410	65	0.5	13
Y105J13105	800VI	M	1510	65	0.5	14
Y105J13115	900	M	1410	60	0.5	14
Y105J13126	900XXL(40mm)	M	1420	40	0.5	TBA
Y105J13136	900XXL(60mm)	M	1420	60	0.5	TBA
Y105J13146	900-4	P	1230	60	1.0	14
Y105J13156	900(07V146730)	P	1529	60	1.0	16
Y105J13166	900	M	1529	60	0.5	16
Y105J13176	900(special 70mm)	M	1529	70	0.5	16
RYQBI						
Y105J13186	2700/2800	P	305	40	5.0	6
Y105J13196	3200&3302M(old)	P	354	40	5.0	6
Y105J13206	3700/2800	E	305	40	5.0	6
Y105J13216	3200 PFA	E	354	28	5.0	6
Y105J13226	3200&3302M(old)	E	355	40	5.0	6
Y105J13236	3302	E	360	40	5.0	6
Y105J13246	3304H	P	364	40	5.0	6
Y105J13256	3304H	E	364	40	5.0	6
Y105J13266	4502	E	453	41	5.0	6
Y105J13276	480N/500N	E	507	45	5.0	9
Y105J13286	480K/480D/500K	E	508	45	5.0	11
Y105J13296	500KNP Numbening Unit	M	510	42	0.5	11
Y105J13306	520/522/524-NP Numbening Unit	M	545	47	0.5	6
Y105J13316	510	E	559	30	3.0	9
Y105J13326	512	E	560	28	5.0	9
Y105J13336	512(pleatic)	P	560	28	5.0	9
Y105J13346	520/522/525	E	572	24.5	5.0	9
Y105J13356	520/522(pleatic)	P	572	24.5	5.0	9
Y105J13366	530/560	E	602	39	5.0	13
Y105J13376	640k	E	736	47	5.0	16
Y105J13386	662 PFH	E	760	40	5.0	11
Y105J13396	750	P	855	34	5.0	12
Y105J13406	750	E	855	34	5.0	12
Y105J13416	920	P	1008	35	5.0	14
Y105J13426	920	E	1005	35	5.0	14





RUBBER BLANKET

Small Thickness Tolerance

Durability

Good dot sharpness

Stable Quality

BLANKET FACTORY



Customize different aluminum bars for different model machine.

- We could offer you all kinds of printing blankets, such as UV blanket, self-adhesive blanket, high-speed sheet-fed offset blanket, web printing blanket, bill printing blanket.
- Thickness: 0.95mm, 1.68mm, 1.95mm.

Feeder



Y107K00200 Die Cutting Machine



Y107K00211 PAPER SIZE:1050* 800 FOR CD/SM102



Y107K00222 PAPER SIZE:740* 520 For MO



Y107K00233 PAPER SIZE:780* 650 FOR SM/CD74



Y107K00244 05机 04机



Y107K00255 08机



Y107K00266 1.PAPER SIZE:1200* 1000 2.PAPER SIZE:1680* 1400

Ink wash Blade



Code	SIZE	
Y107K00271	30*0.152Thick	Single edged
Y107K00281	30*0.152Thick	Double-sided sharpening
Y107K00291	40*0.152Thick	Single edged
Y107K00301	40*0.152Thick	Double-sided sharpening
Y107K00311	50*0.152Thick	Single edged
Y107K00321	50*0.152Thick	Double-sided sharpening
Y107K00331	60*0.152Thick	Single edged
Y107K00341	60*0.152Thick	Double-sided sharpening
Y107K00351	30*0.20Thick	Single edged
Y107K00361	30*0.20Thick	Double-sided sharpening
Y107K00371	40*0.20Thick	Single edged
Y107K00381	40*0.20Thick	Double-sided sharpening
Y107K00391	50*0.20Thick	Single edged
Y107K00401	50*0.20Thick	Double-sided sharpening
Y107K00411	60*0.20Thick	Single edged
Y107K00421	60*0.20Thick	Double-sided sharpening

Stay bar



Code	Y107K00431	Y107K00441	Y107K00451	Y107K00461
L/长度	L=320	L=545	L=670	L=740



Code	Y107K00471	Y107K00481	Y107K00491	Y107K00501	Y107K00511	Y107K00521	Y107K00531	Y107K00541
L/长度	L=165	L=228	L=230	L=240	L=280	L=300	L=340	L=420



Code	Y107K00551	Y107K00561	Y107K00571	Y107K00581	Y107K00591
L/长度	L=300	L=328	L=350	L=380	L=720



Code	Y107K00601	Y107K00611	Y107K00621	Y107K00631	Y107K00641	Y107K00651
L/长度	L=180	L=250	L=280	L=290	L=295	L=420



Code	Y107K00661	Y107K00671	Y107K00681	Y107K00691	Y107K00701
L/长度	L=275	L=285	L=360	L=370	L=515

Spare Parts For Vacuum Pumps

Y108K00711 60A 60A.130A
 Y108K00722 40A 60A. 80A.130A
 Y108K00733 40A 60A. 80A.130A
 Y108K00744 60A.80A
 Y108K00755 60A 60A.130A
 Y108K00766 40A 60A. 80A.130A
 Y108K00777 60A
 Y108K00788 80A_d
 Y108K00800
 Y108K00799
 Y108K00811
 Y108K00822 40A 60A. 80A.130A
 Y108K00833
 Y108K00844
 Y108K00855
 Y108K00866
 Y108K00877
 Y108K00888
 Y108K00899 60A 60A.130A
 Y108K00900
 Y108K00911
 Y108K00922
 Y108K00933
 Y108K00944
 Y108K00955
 Y108K00966
 Y108K00999
 Y108K041000
 Y108K01011
 Y108K01022
 Y108K01033
 Y108K01044
 Y108K01055
 Y108K01066
 Y108K01077
 Y108K01088
 Y108K01099
 Y108K01100
 Y108K01111
 Y108K01133
 Y108K01166
 Y108K01188
 Y108K01199
 Y108K01200
 Y108K01211
 Y108K01222
 Y108K01232
 Y108K01242
 Y108K01252
 Y108K01262
 Y108K01272
 Y108K01282
 Y108K01292
 Y108K01302
 Y108K01312
 Y108K01322
 Y108K01332
 Y108K01342
 Y108K01352
 Y108K01362
 Y108K01372
 Y108K01382
 Y108K01392
 Y108K01402
 Y108K01412
 Y108K01422
 Y108K01432
 Y108K01442

Unit: mm
 a.OD=240 OD²=200 ID=70 H=65
 b.OD=230 OD²=190 ID=47 H=110
 c.OD=225 OD²=190 ID=47 H=75
 d.OD=225 OD²=183 ID=147 H=73

OD=180 OD²=135 ID=14 H=70
 a.OD=95 ID=82 H=20
 b.OD=118 ID=107 H=31
 c.OD=132 ID=119 H=30
 OD=95 ID=82 H=10
 a.OD=140 ID=119 H=55
 b.OD=118 ID=100 H=50
 40A 60A. 80A.130A
 40A 60A. 80A.130A
 40A 60A. 80A.130A
 80A.130A
 60A. 80A. 130A
 a b c a b

Code	Specs
Y108K01222	165×29.5×1.5
Y108K01232	165×30×1.5
Y108K01242	165×32×1.5
Y108K01252	190×22×1
Y108K01262	190×22×1.2
Y108K01272	200×22×1
Y108K01282	200×22×1.5
Y108K01292	200×26×1
Y108K01302	200×28×1.5
Y108K01312	200×28×1.5
Y108K01322	200×30×1.5
Y108K01332	200×32×1
Y108K01342	200×32×1.2
Y108K01352	200×32×1.5
Y108K01362	226×33×1.5
Y108K01372	228×33×1.5
Y108K01382	230×32×1
Y108K01392	230×33×1.5
Y108K01402	230×35×1.5
Y108K01412	260×26×1
Y108K01422	260×26×1.5
Y108K01432	300×32×1
Y108K01442	300×32×1.5

Carbon Blade&Support For Carbon Brush



Code	长 (L)	宽 (W)	厚 (T)	Code	长 (L)	宽 (W)	厚 (T)
Y108K01452	65mm	33mm	4mm	Y108K01572	130mm	50mm	5mm
Y108K01462	80mm	60mm	6mm	Y108K01582	140mm	29mm	4mm
Y108K01472	85mm	40mm	4mm	Y108K01592	165mm	34mm	4mm
Y108K01482	92mm	38mm	4mm	Y108K01602	170mm	38mm	4mm
Y108K01492	95mm	35mm	4mm	Y108K01612	200mm	30mm	4mm
Y108K01502	95mm	43mm	4mm	Y108K01622	200mm	35mm	4mm
Y108K01512	95mm	50mm	6mm	Y108K01632	200mm	40mm	4mm
Y108K01522	95mm	55mm	6mm	Y108K01642	227mm	45mm	4mm
Y108K01532	95mm	59mm	6mm	Y108K01652	230mm	38mm	5mm
Y108K01542	99.5mm	45mm	5mm	Y108K01662	240mm	48mm	4mm
Y108K01552	105mm	40mm	4mm	Y108K01672	260mm	39mm	4mm
Y108K01562	130mm	24mm	4mm	Y108K01682	265mm	45mm	4mm



Paper Drill Bits



#1 Joint Venture Drill Bits
#2 Imitation Import Drill Bits
#3 Import Drill Bits

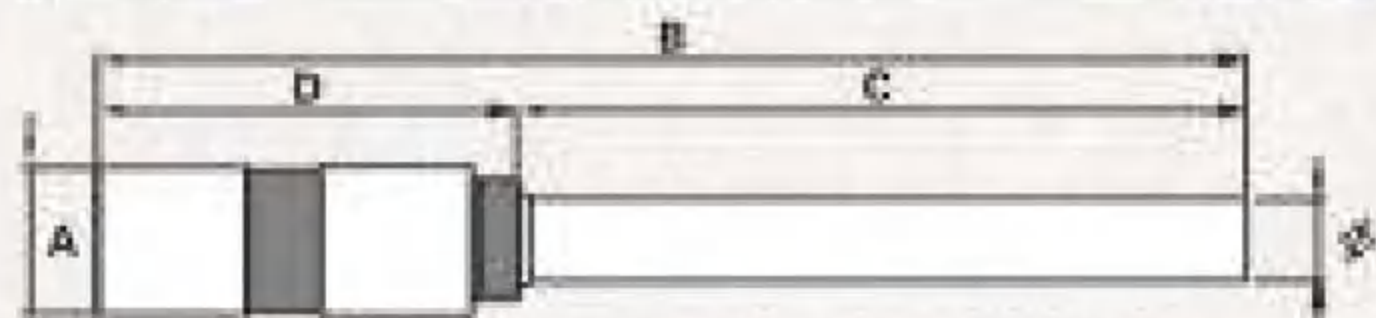

Flat Bottom Drill Bits(#1#2)

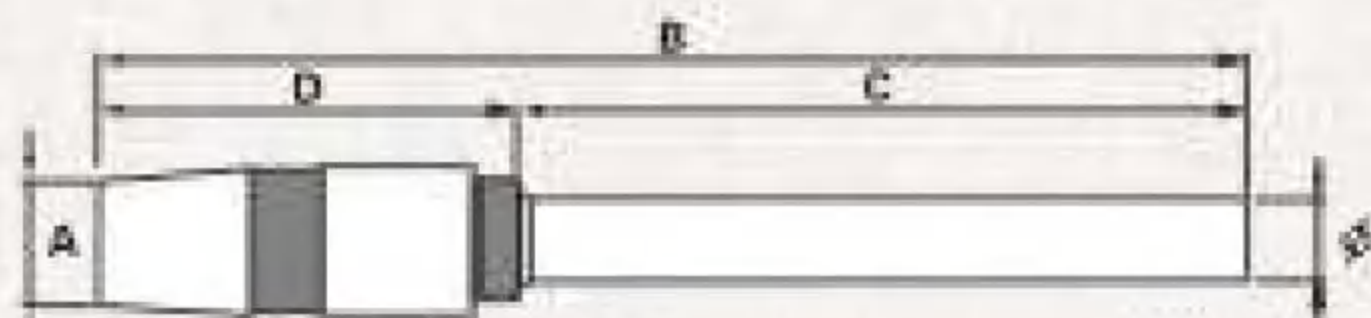

Sloped Bottom Drill Bits(#1#2)

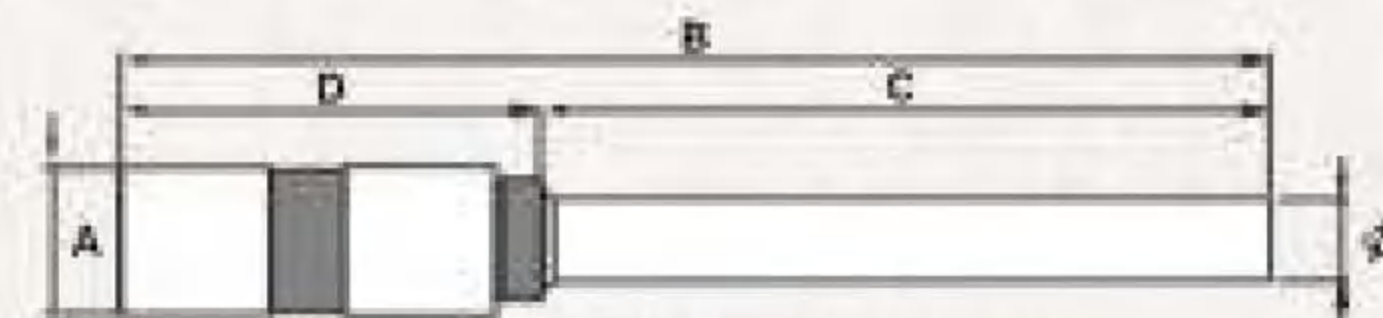

Flat Bottom Drill Bits(#3)

Code	φ mm	A mm	B mm	C mm	D mm
Y109K01731	25	11	60	22	38
Y109K01741	3.0	11	65	33	32
Y109K01751	3.5	11	65	35	30
Y109K01761	4.0	11	71	40	31
Y109K01771	4.5	11	70	39	31
Y109K01781	5.0	11	77	46	31
Y109K01791	5.5	11	77	47	30
Y109K01801	6.0	11	77	46	31
Y109K01811	6.5	11	77	47	30
Y109K01821	7.0	11	77	47	30
Y109K01831	7.5	11	77	44	33
Y109K01841	8.0	11	77	44	33
Y109K01851	8.5	11	77	45	32
Y109K01861	9.0	11	77	45	32
Y109K01871	10.0	11	77	45	32

Code	φ mm	A mm	B mm	C mm	D mm
Y109K01881	2.5	10.5	65	23	42
Y109K01891	3.0	10.5	65	34	31
Y109K01901	3.5	10.5	65	35	30
Y109K01911	4.0	10.0	89	39	30
Y109K01921	4.5	11.0	70	40	30
Y109K01931	5.0	10.5	77	46	31
Y109K01941	5.5	10.5	77	46	31
Y109K01951	6.0	10.5	77	47	30
Y109K01961	6.5	10.5	77	46	31
Y109K01971	7.0	10.5	77	46	32
Y109K01981	7.5	10.5	77	42	35
Y109K01991	8.0	10.0	76	45	31
Y109K02001	9.0	10.5	80	49	31
Y109K02011	10.0	10.5	77	45	32

Code	φ mm	A mm	B mm	C mm	D mm
Y109K02021	2.5	11	65	23	42
Y109K02031	3.0	11	65	33	32
Y109K02041	3.5	11	70	31	39
Y109K02051	4.0	11	77	38	39
Y109K02061	4.5	11	80	41	39
Y109K02071	5.0	11	85	54	31
Y109K02081	5.6	11	85	53	32
Y109K02091	6.0	11	85	55	30
Y109K02101	6.5	11	85	54	31
Y109K02111	7.0	11	83	52	31
Y109K02121	8.0	11	85	53	32
Y109K02131	9.0	11	85	54	31

Carbon Brush



Code	长(L)	度(W)	厚(T)
Y109K02141	40mm	25mm	3mm
Y109K02151	25mm	9mm	6mm
Y109K02161	25mm	10mm	6mm
Y109K02171	25mm	12mm	5.5mm
Y109K02181	25mm	12.5mm	6mm
Y109K02191	30mm	12.5mm	6mm
Y109K02201	25mm	12.5mm	8mm
Y109K02211	25mm	16mm	10mm
Y109K02221	32mm	20mm	10mm
Y109K02231	38mm	25mm	10mm

Code	长(L)	宽(W)	厚(T)
Y109K02241	40mm	25mm	10mm
Y109K02251	40mm	17mm	12.5mm
Y109K02261	30mm	25mm	12.5mm
Y109K02271	25mm	15mm	12mm
Y109K02281	25mm	30mm	15mm
Y109K02291	40mm	17mm	12.5mm
Y109K02301	32mm	20mm	8mm
Y109K02311	28mm	22mm	6.3mm
Y109K02321	25mm	16mm	8mm



Rubber Rollers

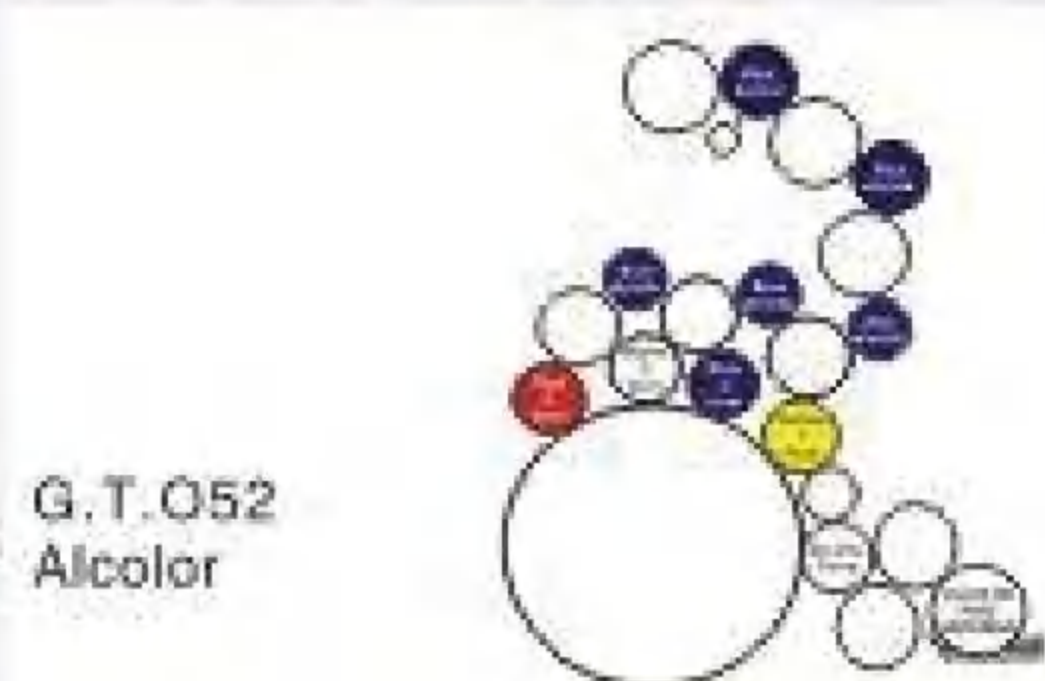
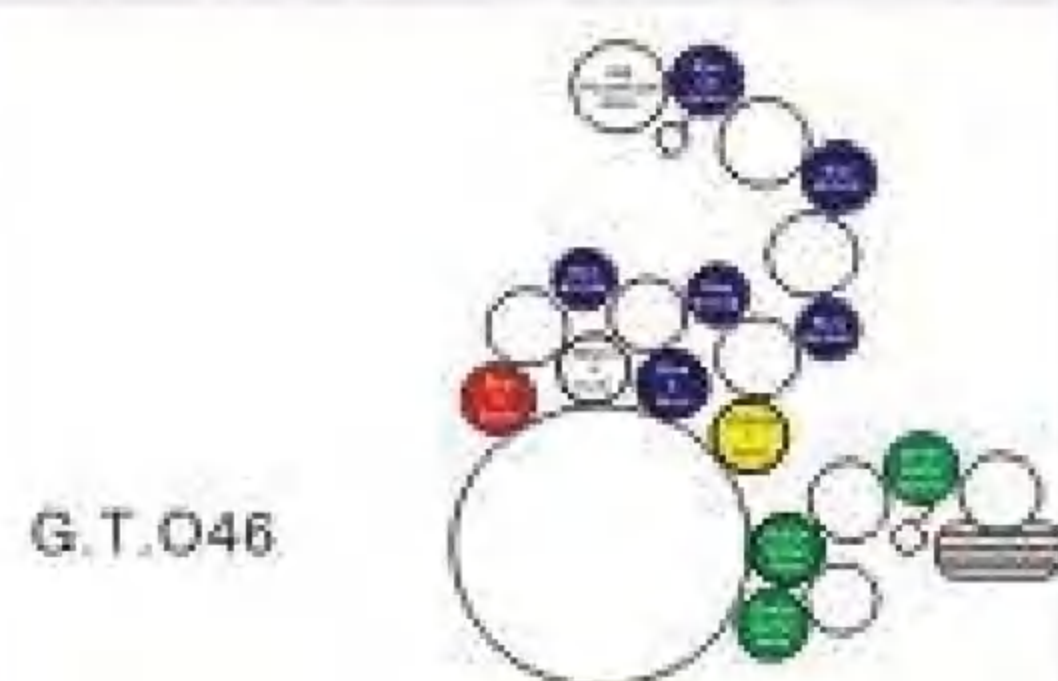
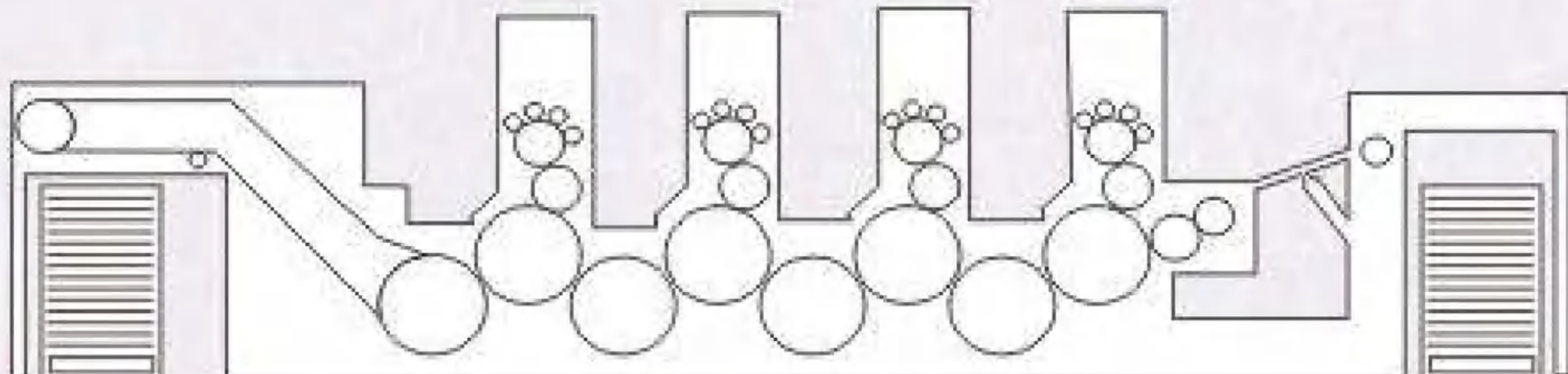

HD G.T.O46

S.NO	ROLLER DESCRIPTION	QTY/PCS	COLOR CODING	RUBBER LENGTH	TOTAL LENGTH
INKING UNIT					
Y110M00011	FORM ROLLER	1	YELLOW	453	538
Y110M00021	FORM ROLLER	1	BLUE	453	536
Y110M00031	FORM ROLLER	1	WHITE	453	536
Y110M00041	FORM ROLLER	1	RED	453	536
Y110M00051	TRANSFER ROLLER	4	BLUE	453	536
Y110M00061	DUCTOR ROLLER	1	BLUE	453	538
DAMPENING UNIT(CONVENTIONAL WATER FORM)					
Y110M00071	FORM ROLLER	2	GREEN	463	536
Y110M00081	DUCTOR ROLLER	1	GREEN	463	536

HD G.T.O46 ALCOLOR

S.NO	ROLLER DESCRIPTION	QTY/PCS	COLOR CODING	RUBBER LENGTH	TOTAL LENGTH
INKING UNIT					
Y110M00091	FORM ROLLER	1	YELLOW	513	596
Y110M00101	FORM ROLLER	1	BLUE	513	596
Y110M00111	FORM ROLLER	1	WHITE	513	596
Y110M00121	FORM ROLLER	1	RED	513	596
Y110M00131	TRANSFER ROLLER	4	BLUE	513	596
Y110M00141	DUCTOR ROLLER	1	BLUE	513	596
DAMPENING UNIT(ALCOLOR)					
Y110M00151	ONLY)	1	GREEN	518	518
Y110M00161	PAN ROLLER (SHELL ONLY)	1	GREEN	530	530

HD G.T.O52 CONVENTIONAL

S.NO	ROLLER DESCRIPTION	QTY/PCS	COLOR CODING	RUBBER LENGTH	TOTAL LENGTH
INKING UNIT					
Y110M00171	FORM ROLLER	1	YELLOW	513	696
Y110M00181	FORM ROLLER	1	BLUE	513	596
Y110M00191	FORM ROLLER	1	WHITE	513	596
Y110M00201	FORM ROLLEA	1	RED	513	596
Y110M00211	TRANSFER ROLLER	4	BLUE	513	596
Y110M00221	DUCTOH ROLLER	1	BLUE	513	596
DAMPENING UNIT(CONVENTIONAL WATER FORM)					
Y110M00231	FORM ROLLER	2	GREEN	523	596
Y110M00241	DUCTOR ROLLER	1	GREEN	523	596
DIRECT DAMPENING UNIT					
Y110M00251	IBAREBACKJ	1	GREEN	574	596
Y110M00261	ROLLER(SHELLONLY)	1	GREEN	533	533
Y110M00271	TRANSFER ROLLER ISHELL	1	GREEN	521	521

HD K.O.R

S.NO	ROLLER DESCRIPTION	QTY/PCS	COLOR CODING	RUBBER LENGTH	TOTAL LENGTH
INKING UNIT					
Y110M00281	FORM ROLLER	1	BLUE	570	619.9
Y110M00291	FORM ROLLER	1	WHITE	570	619.9
Y110M00301	FORM ROLLER	1	RED	570	619.9
Y110M00311	FORM ROLLER	1	BROWN	570	619.9
Y110M00321	TRANSFER ROLLER	1	BLUE	570	619.9
Y110M00331	TRANSFER ROLLER	1	BROWN	570	619.9
Y110M00341	TRANSFER ROLLER	1	WHITE	570	619.9
Y110M00351	TRANSFER ROLLER	1	RED	570	619.9
Y110M00361	DUCTOR ROLLER	1	RED	570	619.9
DAMPENING UNIT(CONVENTIONAL WATER FORM)					
Y110M00371	FORM ROLLER	2	GREEN	585	626.9
Y110M00381	DUCTOR ROLLER	1	GREEN	585	626.9

HD K.O.R.S

S.NO	ROLLER DESCRIPTION	QTY/PCS	COLOR CODING	RUBBER LENGTH	TOTAL LENGTH
INKING UNIT					
Y110M00391	FORM ROLLER	1	BLUE	715	7,799
Y110M00401	FORM ROLLER	1	WHITE	715	779.9
Y110M00411	FORM ROLLER	1	RED	715	779.9
Y110M00421	FORM ROLLER	1	BROWN	715	7,799
Y110M00431	TRANSFER ROLLER	1	BLUE	715	779.9
Y110M00441	TRANSFER ROLLER	1	BROWN	715	779.9
Y110M00451	TRANSFER ROLLER	1	WHITE	715	779.9
Y110M00461	TRANSFER ROLLER	1	RED	715	779.9
Y110M00471	DUCTOR ROLLER	1	RED	715	779.9
DAMPENING UNIT(CONVENTIONAL WATER FORM)					
Y110M00481	FORM ROLLER	2	GREEN	740	786.9
Y110W00491	DUCTOR ROLLER	1	GREEN	740	786.9

HD K.O.R.D 62

S.NO	ROLLER DESCRIPTION	QTY/PCS	COLOR CODING	RUBBER LENGTH	TOTAL LENGTH
INKING UNIT					
Y110M00501	FORM ROLLER	1	BLUE	625	669.9
Y110M00511	FORM ROLLER	1	WHITE	625	669.9
Y110M00521	FORM ROLLER	1	RED	625	669.9
Y110M00531	FORM ROLLER	1	BROWN	625	669.9
Y110M00541	TRANSFER ROLLER	1	BLUE	625	669.9
Y110M00551	TRANSFER ROLLER	1	BROWN	625	669.9
Y110M00561	TRANSFER ROLLER	1	WHITE	625	669.9
Y110M00571	TRANSFER ROLLER	1	RED	625	669.9
Y110M00581	DUCTOR ROLLER	1	RED	625	669.9
DAMPENING UNIT(CONVENTIONAL WATER FORM)					
Y110M00591	FORM HOLLER	2	GREEN	635	676.9
Y110M00601	DUCTOA ROLLER	1	GREEN	635	676.9

■ HD K.O.R.D 64

S.NO	ROLLER DESCRIPTION	QTY/PCS	COLOR CODING	RUBBER LENGTH	TOTAL LENGTH
INKING UNIT					
Y111M00611	FORM ROLLER	1	BLUE	645	709.9
Y111M00621	FORM ROLLER	1	WHITE	645	709.9
Y111W00631	FORM ROLLER	1	RED	645	709.9
Y111W00641	FORM ROLLER	1	BROWN	645	709.9
Y111M00651	TRANSFER ROLLER	1	BLUE	645	709.9
Y111W00661	TRANSFER ROLLER	1	BROWN	645	709.9
Y111M00671	TRANSFER ROLLER	1	WHITE	645	709.9
Y111M00681	TRANSFER ROLLER	1	RED	645	709.9
Y111W00691	DUCTOR ROLLER	1	RED	645	709.9
DAMPENING UNIT (CONVENTIONAL WATER FORM)					
Y111M00701	FORM ROLLER	2	GREEN	670	716.9
Y111M00711	DUCTOR ROLLER	1	GREEN	670	716.9

■ HD S.O.R.K

S.NO	ROLLER DESCRIPTION	QTY/PCS	COLOR CODING	RUBBER LENGTH	TOTAL LENGTH
INKING UNIT					
Y111M00831	FORM ROLLER	1	WHITE	656	717.8
Y111M00841	FORM ROLLER	1	BLUE	656	717.8
Y111M00851	FORM ROLLER	1	RED	656	717.8
Y111M00861	FORM ROLLER	1	YELLOW	656	717.8
Y111M00871	TRANSFER ROLLER	2	WHITE	656	717.8
Y111M00881	TRANSFER ROLLER	1	BLUE	656	717.8
Y111M00891	TRANSFER ROLLER	1	YELLOW	656	717.8
Y111M00901	TRANSFER ROLLER	1	RED	656	717.8
Y111M00911	DUCTOR ROLLER	1	BLUE	656	717.8
DAMPENING UNIT (CONVENTIONAL WATER FORM)					
Y111M00921	FORM ROLLER	2	GREEN	675	717.8
Y111M00931	DUCTOR ROLLER	1	GREEN	690	732.8

■ HD S.O.R.D ALCOLOR

S.NO	ROLLER DESCRIPTION	QTY/PCS	COLOR CODING	RUBBER LENGTH	TOTAL LENGTH
INKING UNIT					
Y111M01051	FORM ROLLER	1	WHITE	905	957
Y111M01081	FORM ROLLER	1	BLUE	905	957
Y111W01071	FORM ROLLER	1	RED	905	957
Y111M01081	FORM ROLLER	1	YELLOW	905	957
Y111M01091	TRANSFER ROLLER	2	WHITE	905	957
Y111M01101	TRANSFER ROLLER	1	BLUE	905	957
Y111M01111	TRANSFER ROLLER	1	YELLOW	905	957
Y111M01121	TRANSFER ROLLER	1	RED	905	957
Y111M01131	DUCTOR ROLLER	1	WHITE	905	957
DAMPENING UNIT (CONVENTIONAL WATER FORM)					
Y111M01141	FORM ROLLER	2	GREEN	910	910
Y111M01151	PAN ROLLER	1	GREEN	930	930

■ HD M.O ALCOLOR

S.NO	ROLLER DESCRIPTION	QTY/PCS	COLOR CODING	RUBBER LENGTH	TOTAL LENGTH
INKING UNIT					
Y111M01271	FORM ROLLER	1	WHITE	654	731
Y111W01281	FORM ROLLER	1	BLUE	654	731
Y111W01291	FORM ROLLER	1	RED	654	731
Y111M01301	FORM ROLLER	1	YELLOW	654	731
Y111M01311	TRANSFER ROLLER	2	RED	654	731
Y111W01321	TRANSFER ROLLER	1	WHITE	654	731
Y111M01331	TRANSFER ROLLER	1	YELLOW	654	731
Y111M01341	TRANSFER ROLLER	1	BLUE	654	731
Y111M01351	DUCTOR ROLLER	1	RED	654	731
DAMPENING UNIT (CONVENTIONAL WATER FORM)					
Y111M01361	FORM ROLLER	1	GREEN	658	658
Y111M01371	PAN ROLLER	1	GREEN	674	674

■ HD S.O.R

S.NO	ROLLER DESCRIPTION	QTY/PCS	COLOR CODING	RUBBER LENGTH	TOTAL LENGTH
INKING UNIT					
Y111M00721	FORM ROLLER	1	WHITE	826	887.8
Y111M00731	FORM ROLLER	1	BLUE	826	887.8
Y111M00741	FORM ROLLER	1	RED	826	887.8
Y111M00751	FORM ROLLER	1	YELLOW	826	887.8
Y111M00761	TRANSFER ROLLER	2	WHITE	826	887.8
Y111M00771	TRANSFER ROLLER	1	BLUE	826	887.8
Y111M00781	TRANSFER ROLLER	1	YELLOW	826	887.8
Y111M00791	TRANSFER ROLLER	1	RED	826	887.8
Y111M00801	DUCTOR ROLLER	1	BLUE	826	887.8
DAMPENING UNIT (CONVENTIONAL WATER FORM)					
Y111M00811	FORM ROLLER	2	GREEN	845	887.8
Y111M00821	DUCTOR ROLLER	1	GREEN	880	902.8

■ HD S.O.R.D CONVENTIONAL

S.NO	ROLLER DESCRIPTION	QTY/PCS	COLOR CODING	RUBBER LENGTH	TOTAL LENGTH
INKING UNIT					
Y111M00941	FORM ROLLER	1	WHITE	896	957.8
Y111M00951	FORM ROLLER	1	BLUE	896	957.8
Y111M00961	FORM ROLLER	1	RED	896	957.8
Y111M00971	FORM ROLLER	1	YELLOW	896	957.8
Y111M00981	TRANSFER ROLLER	2	WHITE	896	957.8
Y111M00991	TRANSFER ROLLER	1	BLUE	896	957.8
Y111M01001	TRANSFER ROLLER	1	YELLOW	896	957.8
Y111M01011	TRANSFER ROLLER	1	RED	896	957.8
Y111M01021	DUCTOR ROLLER	1	BLUE	896	957.8
DAMPENING UNIT (CONVENTIONAL WATER FORM)					
Y111M01031	FORM ROLLER	2	GREEN	957.8	957.8
Y111M01041	DUCTOR ROLLER	1	GREEN	930	972.8

■ HD M.O CONVENTIONAL

S.NO	ROLLER DESCRIPTION	QTY/PCS	COLOR CODING	RUBBER LENGTH	TOTAL LENGTH
INKING UNIT					
Y111M01161	FORM ROLLER	1	WHITE	654	731
Y111M01171	FORM ROLLER	1	BLUE	654	731
Y111M01181	FORM ROLLER	1	RED	654	731
Y111M01191	FORM ROLLER	1	YELLOW	654	731
Y111M01201	TRANSFER ROLLER	2	RED	654	731
Y111M01211	TRANSFER ROLLER	1	WHITE	654	731
Y111M01221	TRANSFER ROLLER	1	YELLOW	654	731
Y111M01231	TRANSFER ROLLER	1	BLUE	654	731
Y111M01241	DUCTOR ROLLER	1	RED	654	731
DAMPENING UNIT (CONVENTIONAL WATER FORM)					
Y111M01251	FORM ROLLER	2	GREEN	670	731
Y111M01261	DUCTOR ROLLER	1	GREEN	674	731

■ HD S.M72 CONVENTIONAL/S.O.R.M

S.NO	ROLLER DESCRIPTION	QTY/PCS	COLOR CODING	RUBBER LENGTH	TOTAL LENGTH
INKING UNIT					
Y111M01381	FORM ROLLER	1	WHITE	726	787.8
Y111M01391	FORM ROLLER	1	BLUE	726	787.8
Y111M01401	FORM ROLLER	1	RED	726	787.8
Y111M01411	FORM ROLLER	1	YELLOW	726	787.8
Y111M01421	TRANSFER ROLLER	2	WHITE	726	787.8
Y111M01431	TRANSFER ROLLER	1	BLUE	726	787.8
Y111M01441	TRANSFER ROLLER	1	YELLOW	726	787.8
Y111M01451	TRANSFER ROLLER	1	RED	726	787.8
Y111M01461	DUCTOR ROLLER	1	BLUE	726	787.8
DAMPENING UNIT (CONVENTIONAL WATER FORM)					
Y111M01471	FORM ROLLER	2	GREEN	745	787.8
Y111M01481	DUCTOR ROLLER	1	GREEN	760	802.8

■ HD S.M72 ALCOLOR/S.O.R.M

S.NO	ROLLER DESCRIPTON	QTY/PCS	COLOR CODING	RUBBER LENGTH	TOTAL LENGTH
INKING UNIT					
Y112M01491	FORM ROLLER	1	WHITE	735	787
Y112M01501	FORMROLLER	1	BLUE	735	787
Y112M01511	FORM ROLLER	1	RED	735	787
Y112M01521	FORM ROLLER	1	YELLOW	735	787
Y112M01531	TRANSFER AOLLER	1	WHITE	735	787
Y112M01541	TRANSFER ROLLER	1	BLUE	735	787
Y112M01551	TRANSFEH ROLLER	2	YELLOW	735	787
Y112M01561	TRANSFER ROLLER	1	RED	735	787
Y112M01571	DUGTOR ROLLER	1	BLUE	735	787
Y112M01581	DUCTORROLLEH(OSC)	1	BROWN	735	772
DAMPENING UNIT (ALCOIOR)					
Y112W01591	FORM ROLLER	1	GREEN	740	740
Y112M01601	PAN ROLLER	1	GREEN	760	760

■ HD S.M74

S.NO	ROLLER DESCRIPTON	QTY/PCS	COLOR CODING	RUBBER LENGTH	TOTAL LENGTH
INKING UNIT					
Y112M01701	FORM ROLLER COMPLETE	1	WHITE	754	814
Y112W01711	FORM ROLLER COMPLETE	1	BLUE	754	814
Y112M01721	FORM ROLLER COMPLETE	1	RED	754	814
Y112M01731	FORM ROLLER COMPLETE	1	YELLOW	754	814
Y112M01741	TRANSFER ROLLER	3	YELLOW	752	821.2
Y112M01751	TRANSFER ROLLER	2	RED	752	821.2
Y112W01761	DUCTOR ROLLER	1	BLACK	750	787
DAMPENING UNIT (ALCOIOR)					
Y112M01771	FORM ROLLER	1	GREEN	752	752
Y112M01781	PAN ROLLER	1	GREEN	768	768

■ HD S.M102 ALCOLOR/S.O.R.S

S.NO	ROLLER DESCRIPTON	QTY/PCS	COLOR CODING	RUBBER LENGTH	TOTAL LENGTH
INKING UNIT					
Y112M01901	FORMROLLER	1	WHITE	1035	1087
Y112M01911	FORM ROLLEA	1	BLUE	1035	1087
Y112M01921	FDRM ROLLER	1	RED	1035	1087
Y112M01931	FORM ROLLER	1	YELLOW	1035	1087
Y112M01941	TRANSFER ROLLER	1	WHITE	1035	1087
Y112M01951	TRANSFER ROLLER	1	BULE	1035	1087
Y112M01961	TRANSFEH ROLLER	2	YELLOW	1035	1087
Y112M01971	TRANSFER ROLLER	1	RED	1035	1087
Y112M01981	DUCTOR ROLLER	1	WHITE	1035	1087
Y112M01991	DUCTOR ROLLER(OSC)	1	BROWN	1035	1071.5
DAMPENING UNIT (ALCOIOR)					
Y112M02001	FORM ROLLER	1	GREEN	1040	1040
Y112M02011	PAN ROLLER	1	GREEN	1060	1060

■ RUOLAN 700

S.NO	ROLLER DESCRIPTON	QTY/PCS	ROLLER DIAMETE	RUBBER LENGTH	TOTAL LENGTH
INKING UNIT					
Y112M02141	FORM ROLLER	1	71	1050	1163
Y112M02151	FORM ROLLER	1	73	1050	1163
Y112M02161	FORM ROLLER	1	69	1050	1163
Y112M02171	FORM ROLLER	1	78	1050	1163
Y112M02181	TRANSFER ROLLER	1	72	1040	1132
Y112M02191	TRANSFER ROLLER	1	90	1040	1274
Y112M02201	TRANSFER ROLLER	1	75	1040	1132
Y112M02211	TRANSFER ROLLER	1	72	1040	1132
Y112M02221	DUCTOH ROLLER	1	71	1022	1081
DAMPENING UNIT					
Y112M02231	FORM ROLLER	1	120.5	1050	1145.7
Y112M02241	METERINO ROLLER	1	85	1065	1186.8

■ HD S.M52

S.NO	ROLLER DESCRIPTION	QTY/PCS	COLOR CODING	RUBBER LENGTH	TOTAL LENGTH
INKING UNIT					
Y112M01611	FORM ROLLER COMPLETE	1	WHITE	538	635.2
Y112M01621	FORM ROLLER COMPLETE	1	BLUE	538	635.2
Y112M01631	FORM ROLLER COMPLETE	1	RED	538	635.2
Y112M01641	FORM ROLLER COMPLETE	1	YELLOW	538	635.2
Y112M01651	TRANSFER ROLLER	4	GREEN	532	607.9
Y112M01661	TRANSFER ROLLER	1	BLACK	532	607.9
Y112M01671	DUCTOR ROLLER	1	VIOLET	520	607.9
DAMPENING UNIT (ALCOIOR)					
Y112M01681	FORM ROLLER	1	GREEN	533	559
Y112M01691	PAN ROLLER	1	GREEN	548	586.5

■ HD S.M102 CONVENTIONAL/S.O.R.S

S.NO	ROLLER DESCRIPTON	QTY/PCS	COLOR CODING	RUBBER LENGTH	TOTAL LENGTH
INKING UNIT					
Y112M01791	FORM ROLLER	1	WHITE	1026	1087
Y112M01801	FORM ROLLER	1	BLUE	1026	1087
Y112M01811	FORM ROLLER	1	RED	1026	1087
Y112M01821	FORM ROLLER	1	YELLOW	1026	1087
Y112M01831	TRANSFER ROLLER	2	WHETE	1026	1087
Y112M01841	TRANSFER ROLLER	1	BLUE	1026	1087
Y112M01851	TRANSFER ROLLER	1	YELLOW	1026	1087
Y112M01861	TRANSFER ROLLER	1	RED	1028	1087
Y112M01871	DUCTOR ROLLER	1	BLUE	1026	1087
DAMPENING UNIT (CONVENTIONAL WATER FORM)					
Y112M01881	FORM ROLLER	2	GREEN	1045	1087
Y112M01891	DUCTOR ROLLER	1	GREEN	1045	1102

■ RUOLAN PARVA 2C

S.NO	ROLLER DESCRIPTON	QTY/PCS	ROLLER DIAMETE	RUBBER LENGTH	TOTAL LENGTH
INKING UNIT					
Y112M02021	FORM ROLLER	2	70	935	1133.7
Y112M02031	FORM ROLLER	2	60	935	1133.7
Y112M02041	FORM ROLLER	2	65	935	1133.7
Y112M02051	FORM ROLLER	2	75	935	1133.7
Y112M02061	TRANSFER ROLLER	1	44	935	1147
Y112M02071	TRANSFER ROLLER	1	85	935	1203
Y112M02081	TRANSFER ROLLER	4	50	935	1203
Y112M02091	TRANSFER ROLLER	2	55	935	1203
Y112M02101	TRANSFER ROLLER	3	55	935	1051
Y112M02111	DUCTOR ROLLER	2	60	935	1059
DAMPENING UNIT					
Y112M02121	FORM ROLLER	2	61	935	1151
Y112M02131	DUCTOR ROLLER	1	56	969	1056

■ RUOLAN Parva 2B

S.NO	ROLLER DESCRIPTON	QTY/PCS	ROLLER DIAMETE	RUBBER LENGTH	TOTAL LENGTH
INKING UNIT					
Y112M02251	FORM ROLLER	2	70	935	935
Y112M02261	FORM ROLLER	2	60	935	935
Y112M02271	FORM ROLLER	2	65	935	935
Y112M02281	FORM ROLLER	2	75	935	935
Y112M02291	TRANSFER ROLLER	4	50	935	935
Y112M02301	TRANSFER ROLLER	1	85	935	935
Y112M02311	TRANSFER ROLLER(L)	2	55	935	935
Y112M02321	TRANSFER ROLLER(S)	3	55	935	935
Y112M02331	DUCTOR ROLLER	2	60	935	935
DAMPENING UNIT					
Y112M02341	FORM ROLLER	4	65	925	925
Y112M02351	METERING ROLLER	2	60	945	945

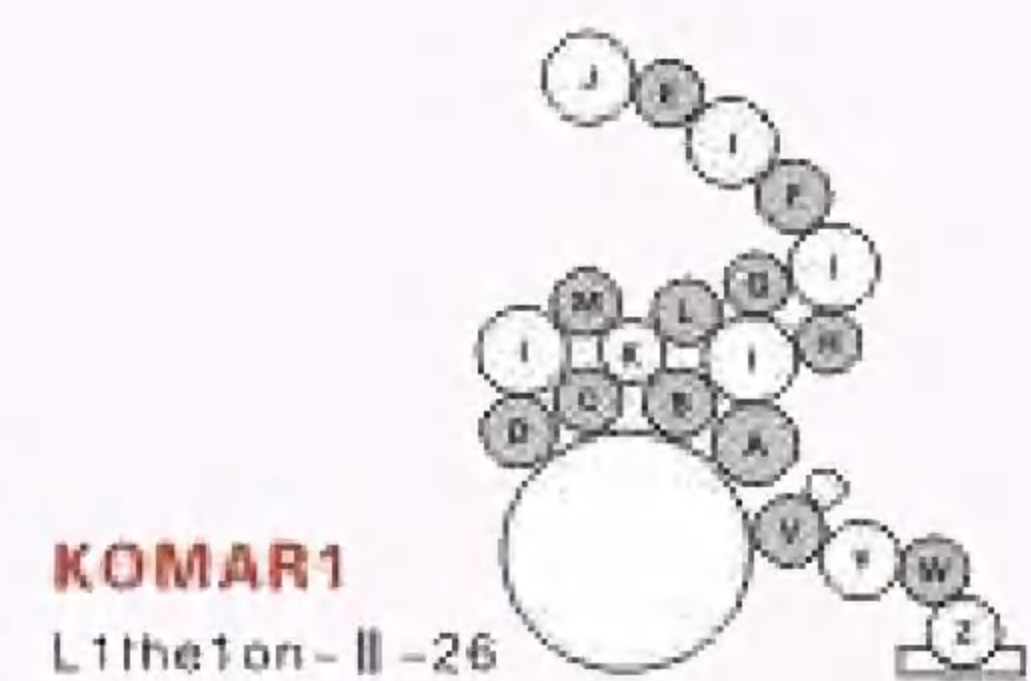

■ KOMAR1 L1the1on-26-3g0f

S.NO	Inker Position	Set Q.	ID	OD	FL	OAL
Y113M02361	AForm	1	38.1	64.5	674	722
Y113M02371	AForm (Hickey Picker)	Option				
Y113M02381	B Form	1	50.8	70	674	766
Y113M02391	C Form	1	38.1	60	674	722
Y113M02401	D Form	1	50.8	75	674	766
Y113M02411	E Ductor	1	38.1	60	674	740
Y113M02421	G Distributor	3	38.1	65	674	766
Y113M02431	H Distributor	1	57.1	82	674	766
Y113M02441	M Bdet	1	38.1	60	674	740
Dampening System						
Y113M02451	V Water Form'	1	38.1	65	678	736
Y113M02461	V Water Form	1	44.5	65	678	766
Y113M02471	W Water Meter	1	47.6	73	748	822

■ KOMAR1 Sp1c1a-429

S.No	Inker Pnsition	Set Q.	ID	OD	FL	OAL
Y113M02481	AForm	1	38.1	68	754	830
Y113M02491	B Form	1	48.5	65	754	874
Y113M02501	C Form	1	38.1	61	754	830
Y113M02511	D Form	1	48.5	71	754	874
Y113M02521	F Ductot	1	38.1	60	770	830
Y113M02531	F Distributor	1	38.1	67	754	830
Y113M02541	G Distributor	1	38.1	80	754	R0
Y113M02551	H Distributor	1	38.1	60	754	830
Y113M02561	LDiefributot	1	38.1	60	754	874
Y113M02571	M Distributor	1	38.1	60		874
Dampening System						
Y113M02581	V Water Fom	1	38.1	65	768	898
Y113M02591	W Water Meter	1	48.5	73	826	930

■ KOMAR1 SPLRNT-28

S.NO	Inker Position	Set Q.	ID	OD	FL	OAL
Y113M02601	AForm	1	38.1	64.5	734	782
Y113M02611	AForm (Hickey Picker)	Oplion				
Y113M02621	B Form	1	50.8	70	734	826
Y113M02631	C Form	1	38.1	60	734	782
Y113M02641	D Form	1	50.8	75	734	826
Y113M02651	E Ductor	1	38.1	60	734	800
Y113M02661	F Distributor	1	38.1	65	734	826
Y113M02671	G Distrbutor	1	38.1	60	734	826
Y113M02681	H Distributor	1	57.1	82	734	828
Y113M02691	M Distributor	1	38.1	50	734	826
Y113M02701	K Distnbutor	1		60	734	782
Dampening Syatam						
Y113M02711	V Water Form	1	38.1	65	738	792
Y113M02721	WWater Mete	1	47.6	73	808	840

■ KOMAR1 L1the1on-||-26

S.NO	Inker Position	Set Q.	ID	OD	FL	OAL
Y113M02731	AForm			67	674	740
Y113M02741	AForm (Hickey Picker)	Option				
Y113M02751	B Fom	1	48.5	64	674	784
Y113M02761	C Form	1	38.1	60	674	740
Y113M02771	D Form	1	48.5	70	674	784
Y113M02781	E Ductor	1	38.1	60	674	740
Y113M02791	F Distributo	1	38.1	67	674	740
Y113M02801	G Distnbutor	1	38.1	60	674	740
Y113M02811	H Distributor	1	38.1	60	674	740
Y113M02821	LDistribute	1	38.1	60	674	784
Y113M02831	M Distributor	1	38.1	60	674	784
Dampening System						
Y113M02841	V Water Form	1	38.1	65	678	792
Y113M02851	w Water Meter	1	48.5	73	736	840

■ KOMAR1 L1the1on-40-0g1t1u

S.NO	Inker Position	Set Q.	ID	OD	FL	OAL
Y113M02861	AForm	1	64	87.5	1035	1102
Y113M02871	AForm (Hickey Picker)	Option				
Y113M02881	B Form	1	57	77.5	1035	1114
Y113M02891	B Form (Cocking)	Option				1102
Y113M02901	C Form	1	64	85	1035	1102
Y113M02911	D Form	1	70	90	1035	1114
Y113M02921	D Form(Cocking)	Option				1102
Y113M02931	E Ductor	1	45	64	1035	1122
Y113M02941	F Distributor	2	51	75	1035	1098
Y113M02951	H Distributor	1	64	85	1035	1147
Y113M02961	S Distrhutar	1	76	97	1035	1147
Y113M02971	TDistnbutor	1	51	70	1035	1074
Y113M02981	PRidder	1	45	55	1035	1035
Dampening System						
Y113M02991	V water Form	1	76	102	1042	1112
Y113M03001	V Water Form	Option		101		1150
Y113M03011	V waler F orm	Cption		101		1168
Y113M03021	W Water Meter	1	60	86	1112	1205

■ KOMAR1 L1the1on-40-1g1g

S.NO	Inker Position	Set Q.	ID	OD	FL	OAL
Y113M03031	AForm	1	64	87.5	1035	1102
Y113M03041	AForm (Hickey Picker)	Option				
Y113M03051	B Fom	1	57	77.5	1035	1114
Y113M03061	B Form (Cocking)	Option				1102
Y113M03071	C Form	1	64	85	1035	1102
Y113M03081	D Form	1	70	90	1035	1114
Y113M03091	D Form (Cocking)	Option				1102
Y113M03101	E Ductor	1	45	64	1035	1122
Y113M03111	F Diatributar	2	51	75	1035	1098
Y113M03121	H Distributor	1	64	85	1035	1147
Y113M03131	G Distrpator	1	51	70	1035	1126
Y113M03141	(G)Distributor (short)	1				1074
Y113M03151	S Distributor	1	76	97	1035	1147
Y113M03161	PRider	1	45	55	1035	1035
Dampening System						
Y113M03171	V Water Form ¹	1	76	102	1042	1112
Y113M03181	V Water Form ²	Option		101		1150
Y113M03191	V Water Form ³	Option		101		1168
Y113M03201	W Water Meter	1	60	86	1112	1205

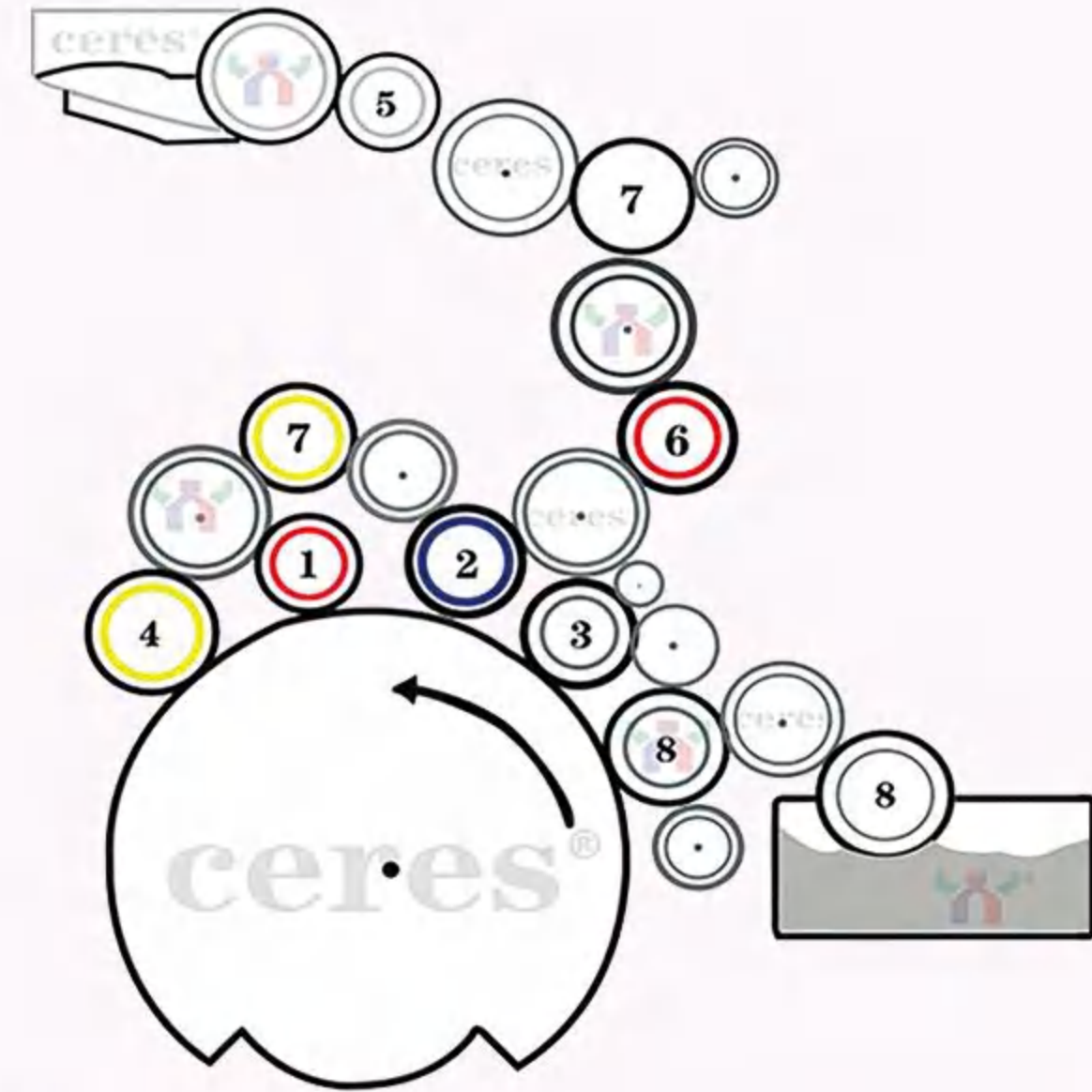

Double Wire



YYHB-520A SEMI-AUTOMATIC DOUBLE WIRE CLOSING MACHINE



Printing Chemical



YY-363 Plate Cleaner



YY-369UV Plate Cleaner



Blanket Reductant



YY-338 Gum Solution



Super Clean



Lube Clean



Quick Print



Quick Drier



Fountain Solution



Alcofree Fountain Solution YF-100



Roller Wash



UV Roller Wash



Developer
Developer Powder



Conditioning Paste
Image Remover Pen



Ceres Spray Powder

Hot Melt Adhesive for Bookbinding



YY-1102



YY-1108



YY-1109

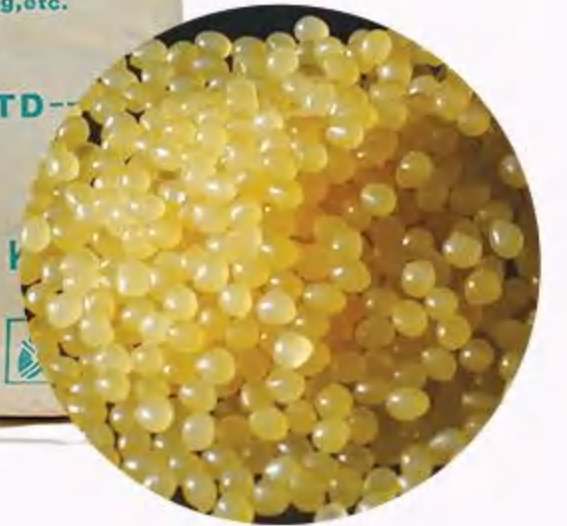

YY-1112



OUR FRIENDSHIP LASTS FOREVER



OUR FRIENDSHIP LASTS FOREVER







 **ceres**®  **INKLOVE**®  **EISI**®

Print Area Technology Co.,Ltd

 www.enyyink.com / www.yyeisi.com / <https://www.offsetsecurityink.com>

 yinya@enyyink.com / uvink@yyink.com / fluorescentink@yyink.com

China   +86 173 2801 1019 / +86 173 2801 8319 / +86 136 5088 7457

Thailand   09 5265 8467 / 08 2987 3377

 1714/3-5 หมู่ที่9 ตำบลเทพารักษ์ อำเภอเมืองสมุทรปราการ จังหวัดสมุทรปราการ 10270

Myanmar   9-261036298 / 9-261480718

 No.297,40th Street,Upper Block,Kyauk Tada Township,Yangon, Myanmar